

# Cat treadmill 4.0 M installation

## Instructions Hint:

Do not tighten the mounting screws to the end at one time, and tighten them again after a single component is installed and formed !

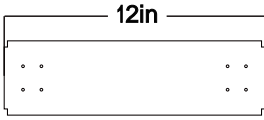

**A** × 2



**P** × 2

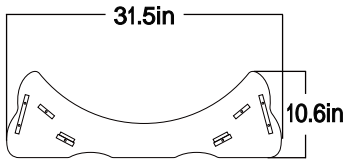

**B** × 2

\* **B** Base for cat treadmill

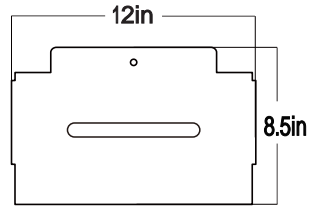

**C** × 2

\* **C** A plank with only one screw hole

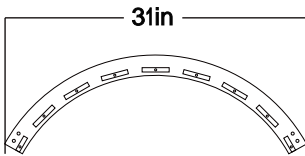

**D** × 6

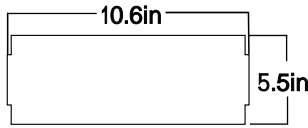

**E** × 17

\* Three pieces of E have double holes in the side! Connecting D and D !

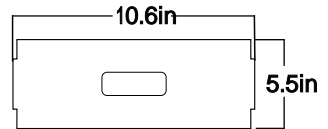

**F** × 1

\* **F** Empty space in the center.

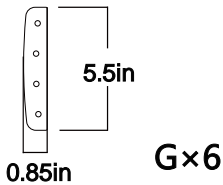

0.85in

**G** × 6

\* **G** Connecting D and D !

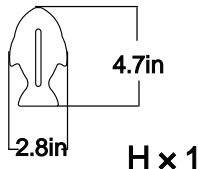

2.8in

**H** × 1

\* **H** Insert F to prevent rotation.

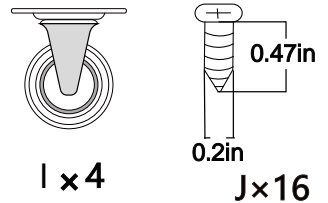

**I** × 4

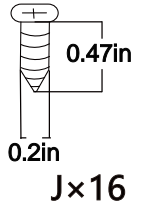

0.2in

**J** × 16

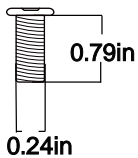

0.79in

0.24in

**K** × 24

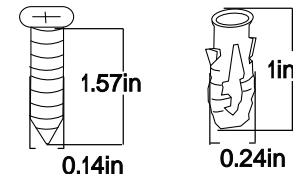

1.57in

0.14in

**L** × 58



1in

0.24in

**M** × 58

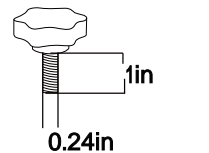

1in

0.24in

**N** × 1

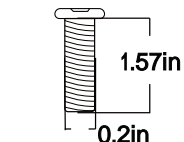

1.57in

0.2in

**Q** × 4

\* **Q** Long screw



**R** × 4

\* **R** Install on P-plate with Q-screws and torque with S-nuts.



**S** × 4

\* **S** Locking Q-screw and R-wheel.

# Detailed installation steps :

## STEP 1

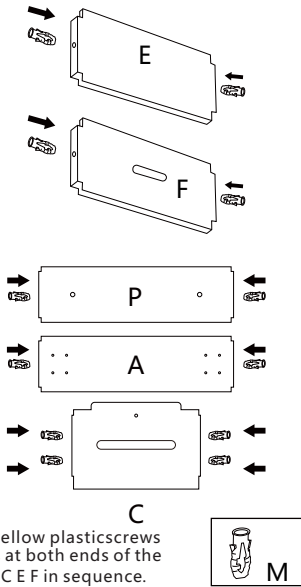

## STEP 2

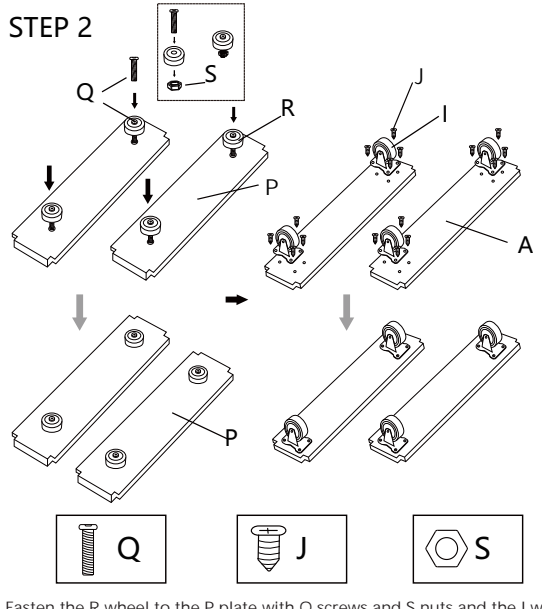

## STEP 3

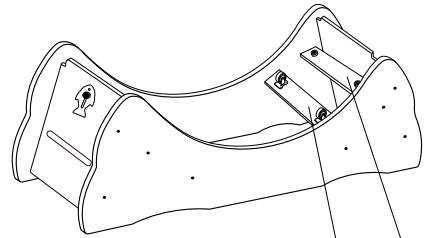
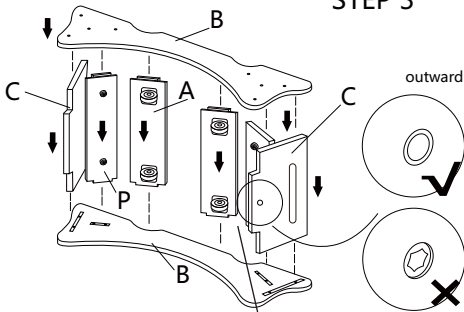

Base installation complete

The two A plates with I wheels are at the bottom, and close to the A plates are the two P plates with R wheels.

\* Note that the F plate should be placed in the middle of the horizontal plate arrangement in the arc plate (such as the third of the 5 horizontal plates, the fourth of the 7 horizontal plates, the actual object shall prevail)  
F plates cannot be placed at curved plate joints.

STEP 4

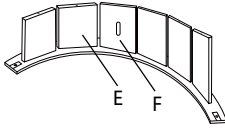

STEP 5

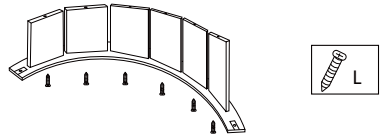

STEP 6

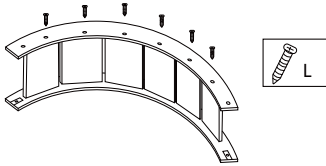

STEP 7

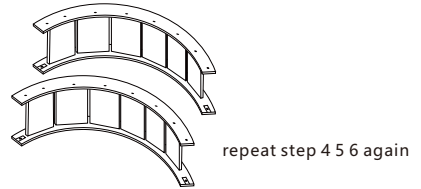

STEP 8

Here, use E with double holes for installation.

STEP 9

STEP 10

Mount the G here with the K screws, it will make the connection stronger.

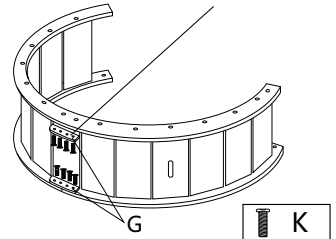
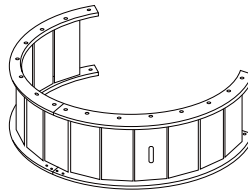
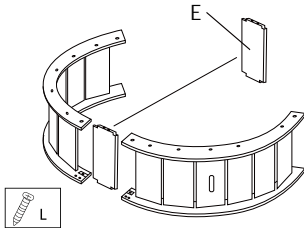

STEP 11

STEP 12

STEP 13

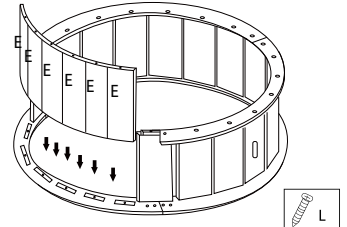
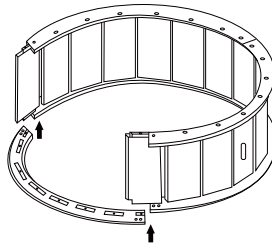
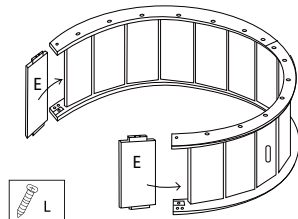

STEP 14

STEP 15

STEP 16

Place the rollers on the base.

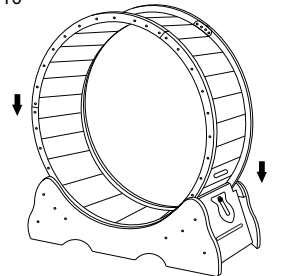
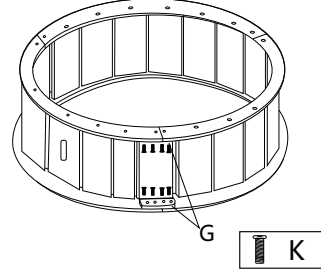
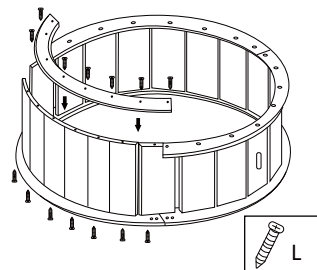

**STEP 17**

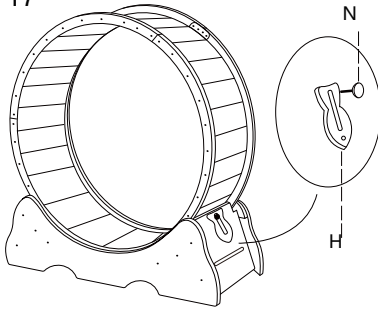

Secure H to the side panel with N.

**STEP 18**

Please paste the black buckle as shown in the figure below.

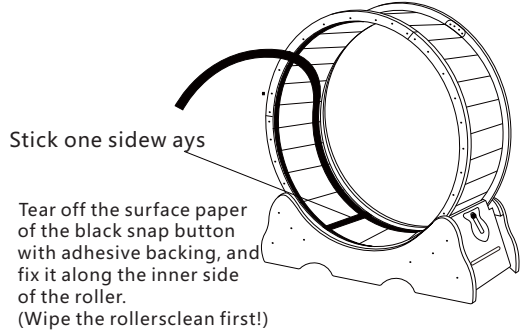

**STEP 19**

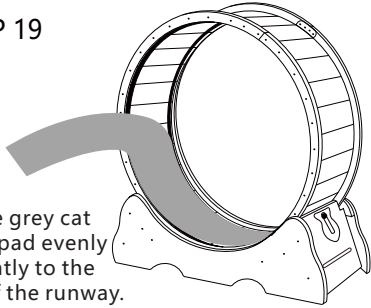

Glue the grey cat scratch pad evenly and tightly to the inside of the runway.

**STEP 20**

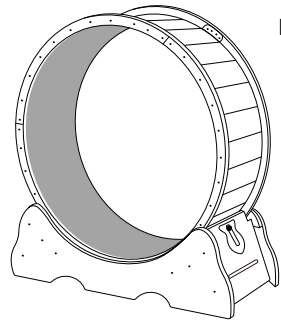

Finished

Lock it when not in use

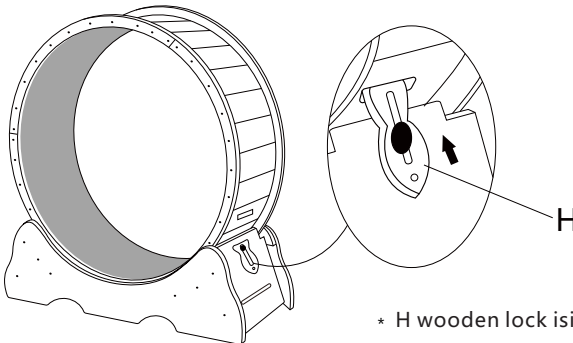

\* H wooden lock is inserted into the card slot and locked.