

FULL SIZE LOFT BED ASSEMBLY INSTRUCTIONS

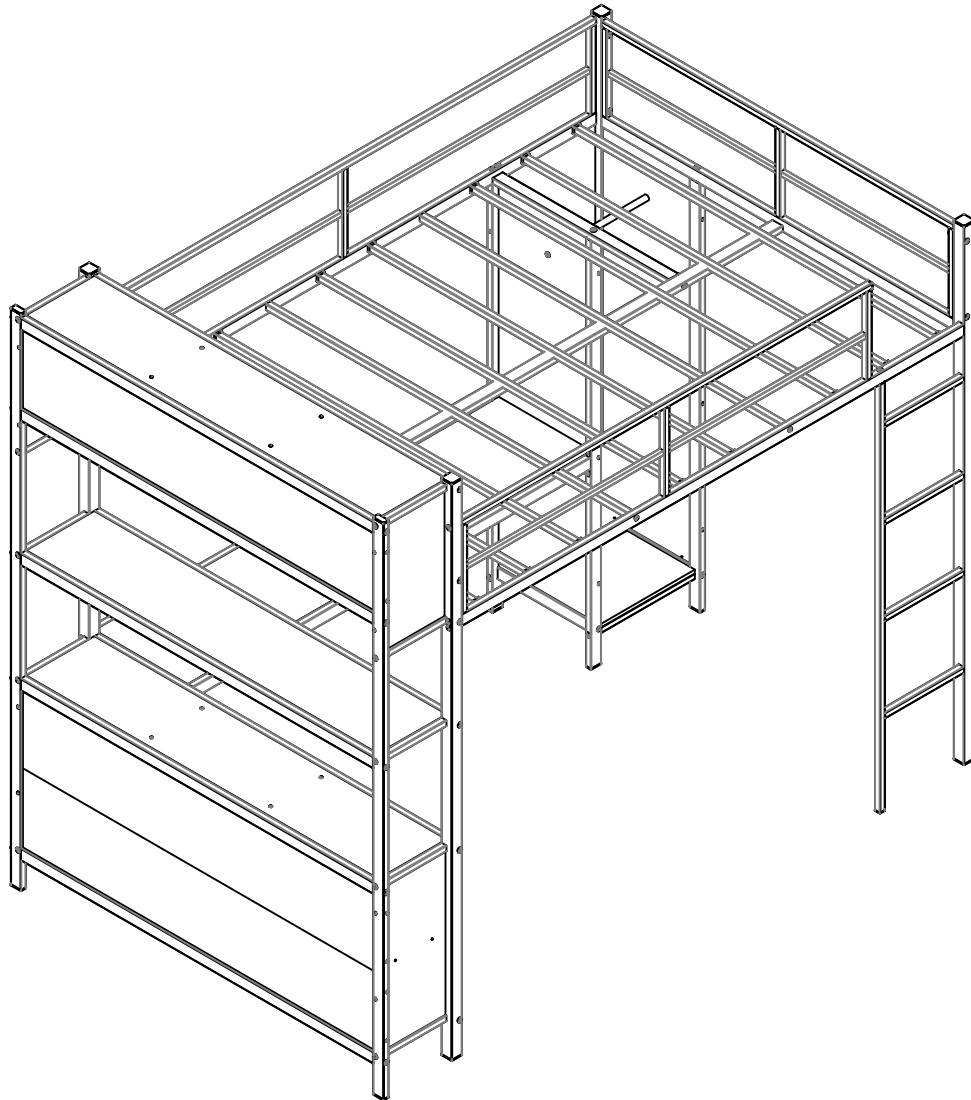

SAFETY WARNINGS AND GENERAL NOTES:

1. Follow the information on the warnings on the bunk bed end structure and on the carton. Do not remove the warning label from the bed.
2. Always use the recommended size mattress on mattress support, or both, to help prevent the likelihood of entrapment or falls.
3. Do not allow children under 6 years of age to use the upper bunk.
4. Periodically check and ensure the guardrail, ladder and other components are in their proper position, free from damage, and all connectors are tight.
5. Do not allow horseplay on or under beds.
6. Always prohibit jumping on the bed.
7. Prohibit more than one person on upper bunk.
8. Always use the ladder for entering and leaving the upper bunk.
9. Do not use substitute parts. Contact the manufacturer or dealer for replacement parts.
10. Use of a night-tight may provide added safety precaution for a child using the upper bunk.

11. Always use guardrails on both long sides of the upper bunk.
12. If the bunk bed will be placed next to a wall, the guardrail that runs the full length of the bed should be placed against the wall to prevent entrapment between the bed and the wall.

The use of water or sleep flotation mattresses is prohibited.

13. **STRANGULATION HAZARD**-Never attach or hang items to any part of the bunk bed that is not designed for use with the bed.
14. Keep these instructions for future reference.

15. We recommend assembling your bunk bed on the shipping carton to protect your floor or carpet.

16. Be certain all staples are out of the box before beginning assembly on the shipping carton.

17. **USE ONLY MATTRESSES WHICH ARE AS THE TABLE BELOW ON UPPER AND ON LOWER BUNKS.**

Up bed (bunk bed and tribed included)

Mattress size	Length	Width	Thickness
Full Standard	75"	54"	6" max







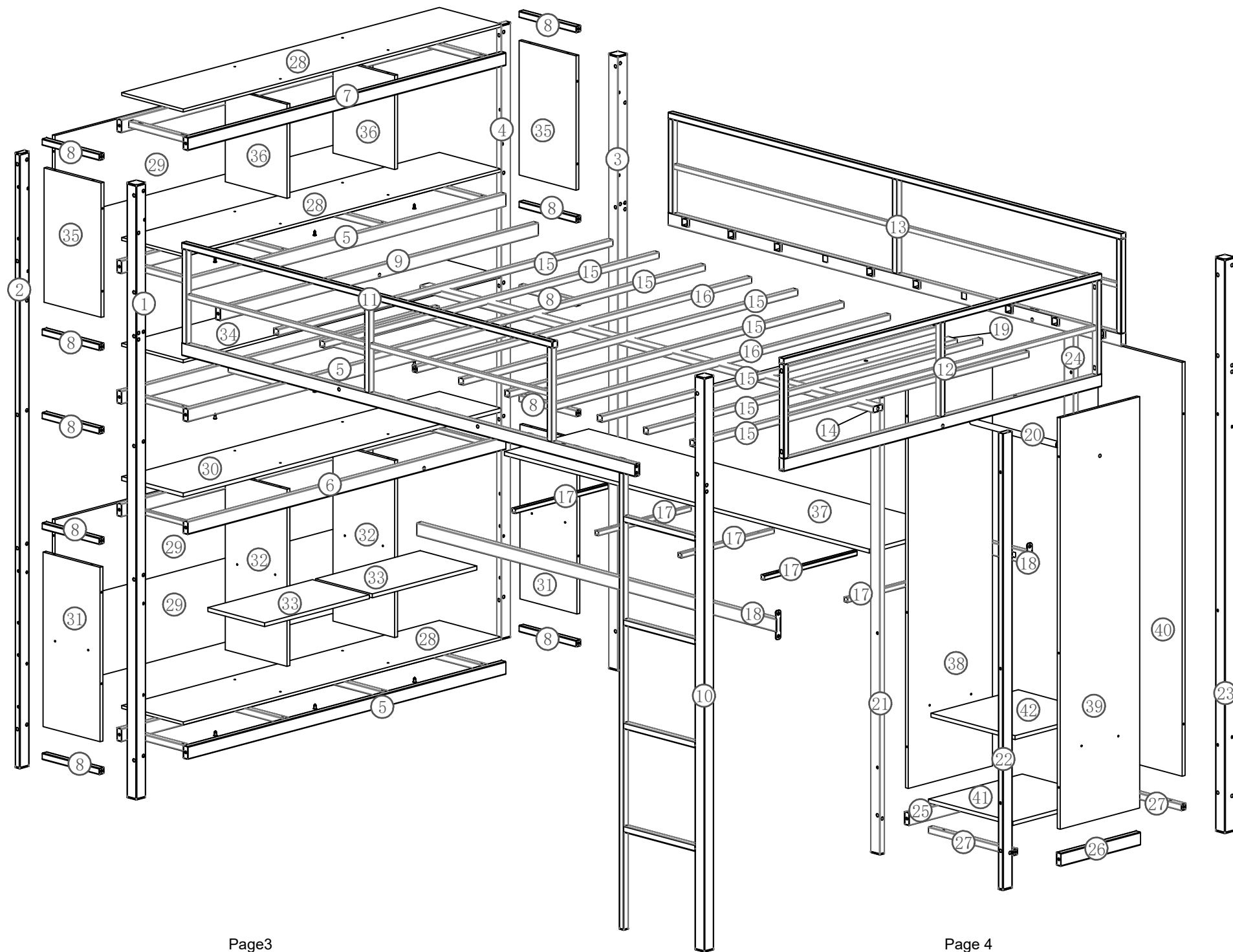



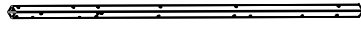
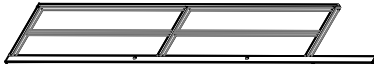

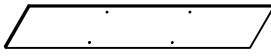
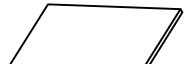



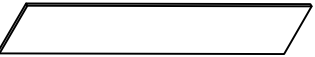
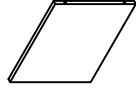

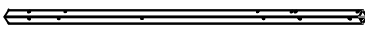

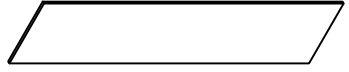

18. **SURFACE OF MATTRESS MUST BE AT LEAST 5"(127MM) BELOW THE UPPER EDGE OF GUARDRAILS.**

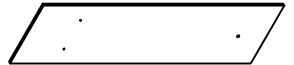
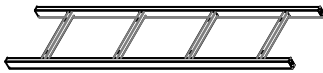

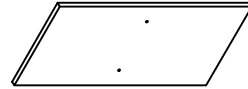
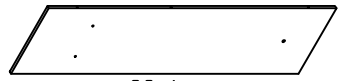

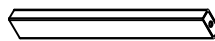
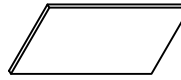
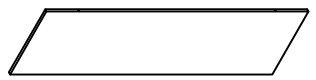
19. Replacement Parts:

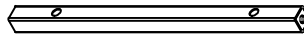
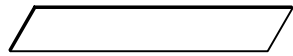
Replacement Parts, including additional guardrails, may be obtained from any of our dealers.



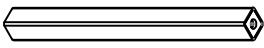

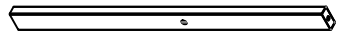

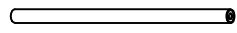









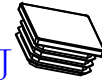

Part List

 1-1pcs	 11-1pcs	 21-1pcs	 28-3pcs	 35-2pcs	
 2-1pcs	 12-1pcs	 22-1cs	 29-3pcs	 36-2pcs	
 3-1pcs	 13-1pcs	 23-1pcs	 30-1pcs	 37-1pcs	
 4-1pcs	 14-1pcs	 24-1pcs	 31-2pcs	 38-1pcs	
 5-3pcs	 15-8pcs	 25-1pcs	 32-2pcs	 39-1pcs	
 6-1pcs	 16-2pcs	 26-1pcs	 33-2pcs	 40-1pcs	
 7-1pcs	 17-5pcs	 27-2pcs	 34-1pcs	 41-1pcs	 42-1pcs

 8-10pcs	 18-2pcs
 9-1pcs	 19-1pcs
 10-1pcs	 20-1pcs

Part List





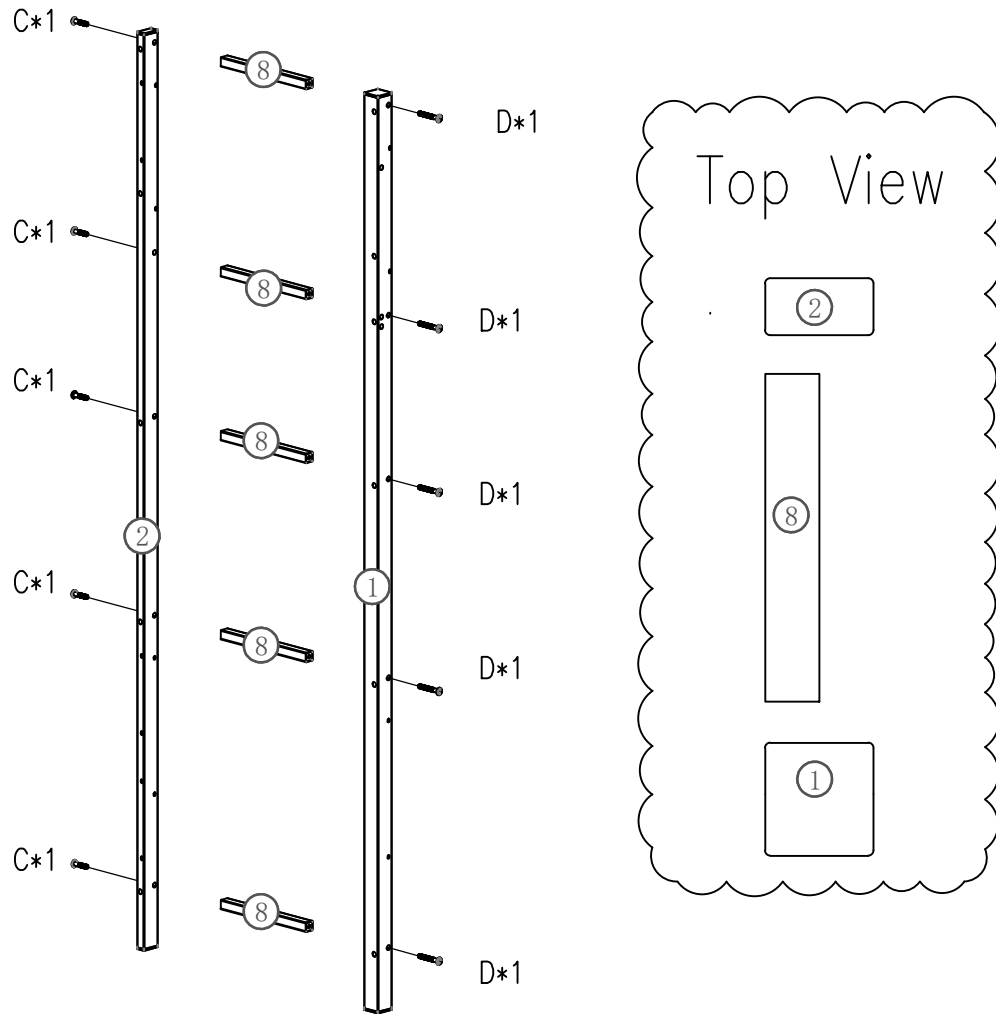

 A 4*8 46PCS	 B 8*15 5PCS	 C 8*35 26PCS	 D 8*55 57PCS	 E 8*15-4PCS	 F 16PCS	 G 4*25-16PCS	 H 4*50-30PCS	 I 4*35-14PCS	 L	 J (Installed)	 K (Installed)	 M (Installed)	 N	 O 5*10-4PCS	 P 5*10-8PCS
--	--	---	---	---	---	--	--	--	--	---	---	---	--	---	---

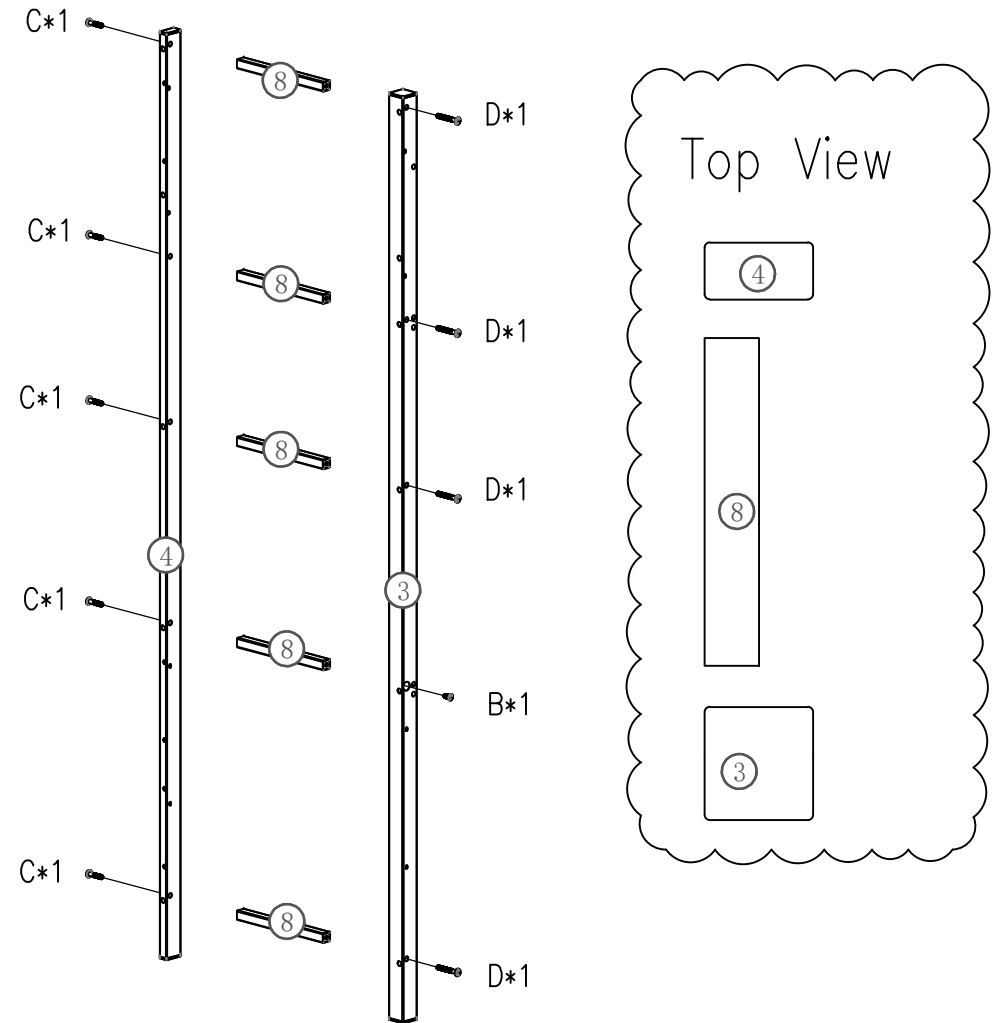





Step 1: Use hardware C,D,N to connect #1,#2 and #8 together.



Step 2: Use hardware C,D,N to connect #3,#4 and #8 together.



					
1-1pcs	2-1pcs	8-5pcs	C 8*35 5PCS	D 8*55 5PCS	N



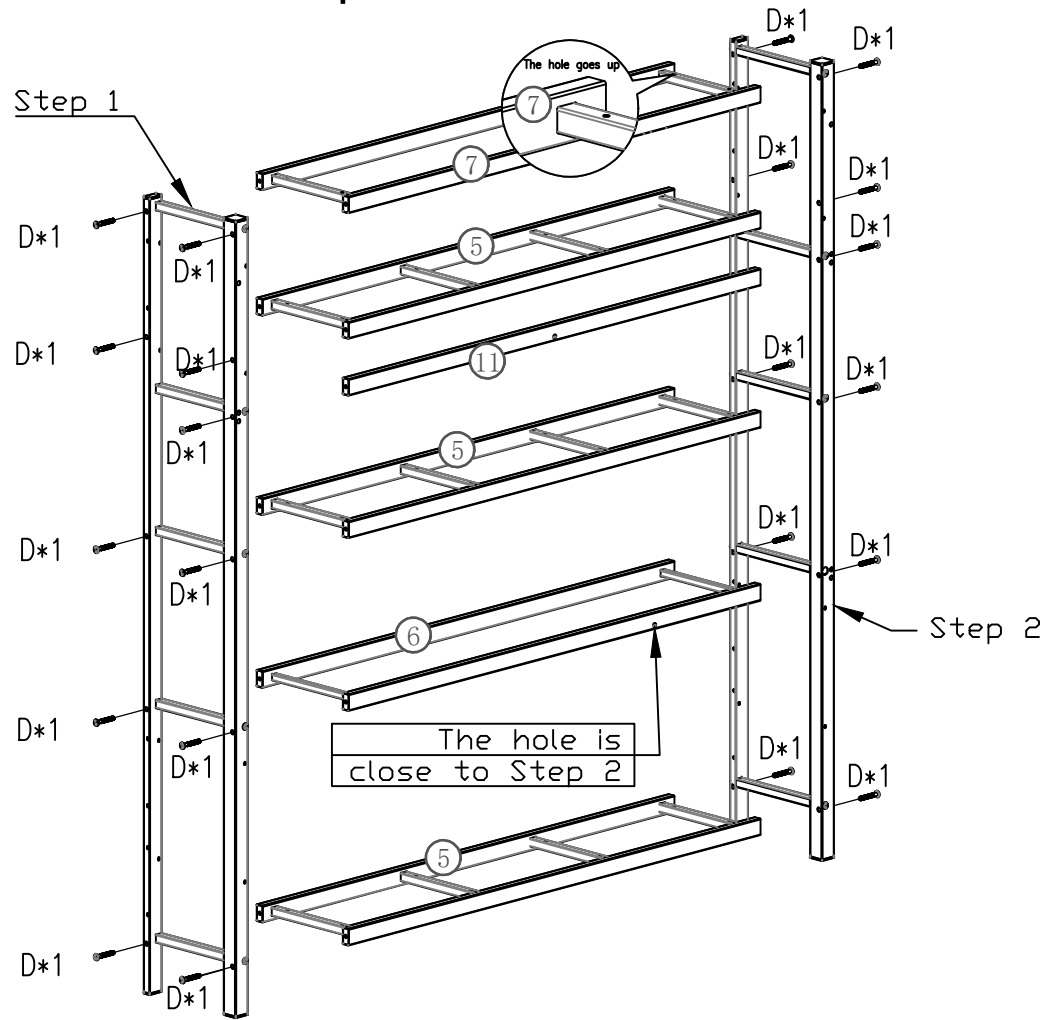

						
3-1pcs	4-1pcs	8-5pcs	B 8*15 1PCS	C 8*35 5PCS	D 8*55 4PCS	N



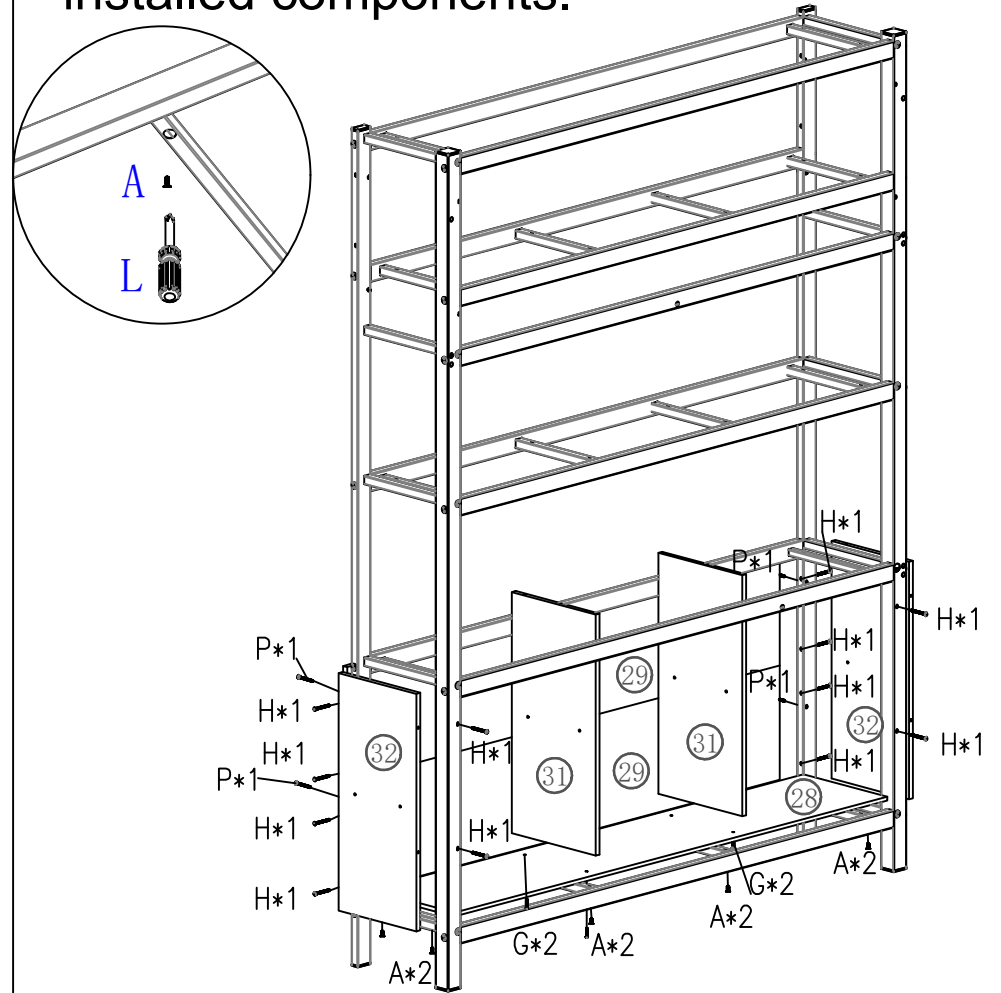

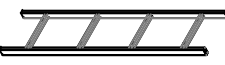



Step 3: Use hardware N and D to connect #5,#6,#7 and #11 to the previously installed components.

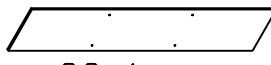
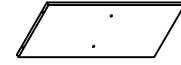

Step 4: Use hardware L,A,G,H to connect #28,#29,#31 and #32 to the previously installed components.



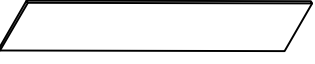





				
5-3pcs	6-1pcs	7-1pcs	D	N
		11-1pcs	8*55	
			22PCS	

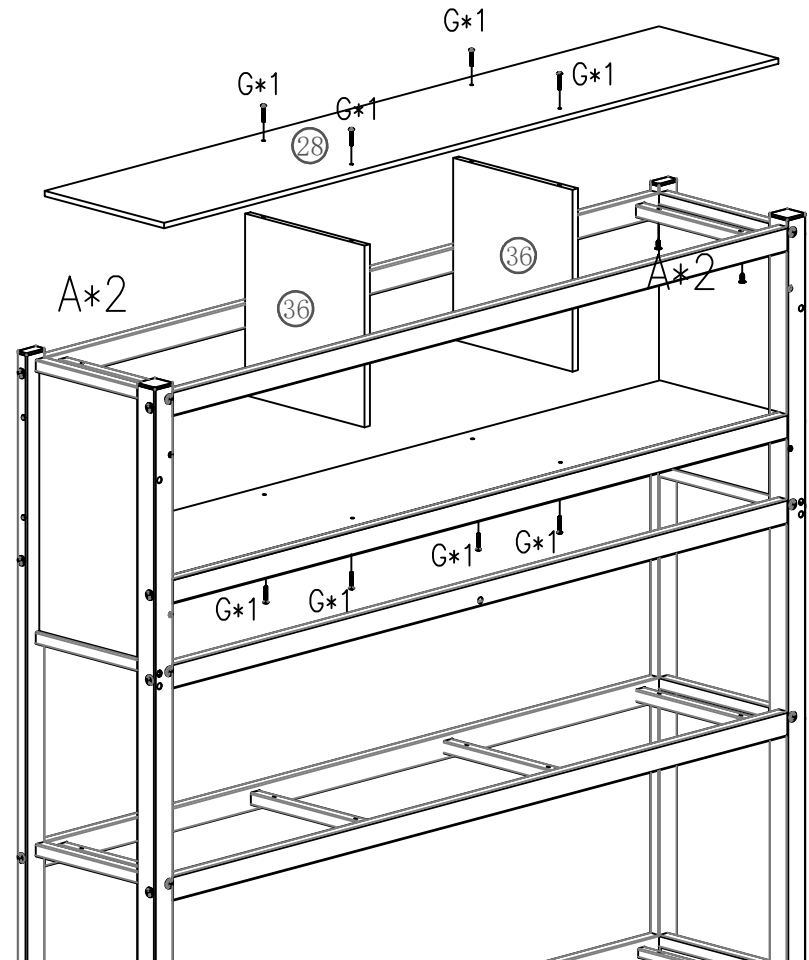
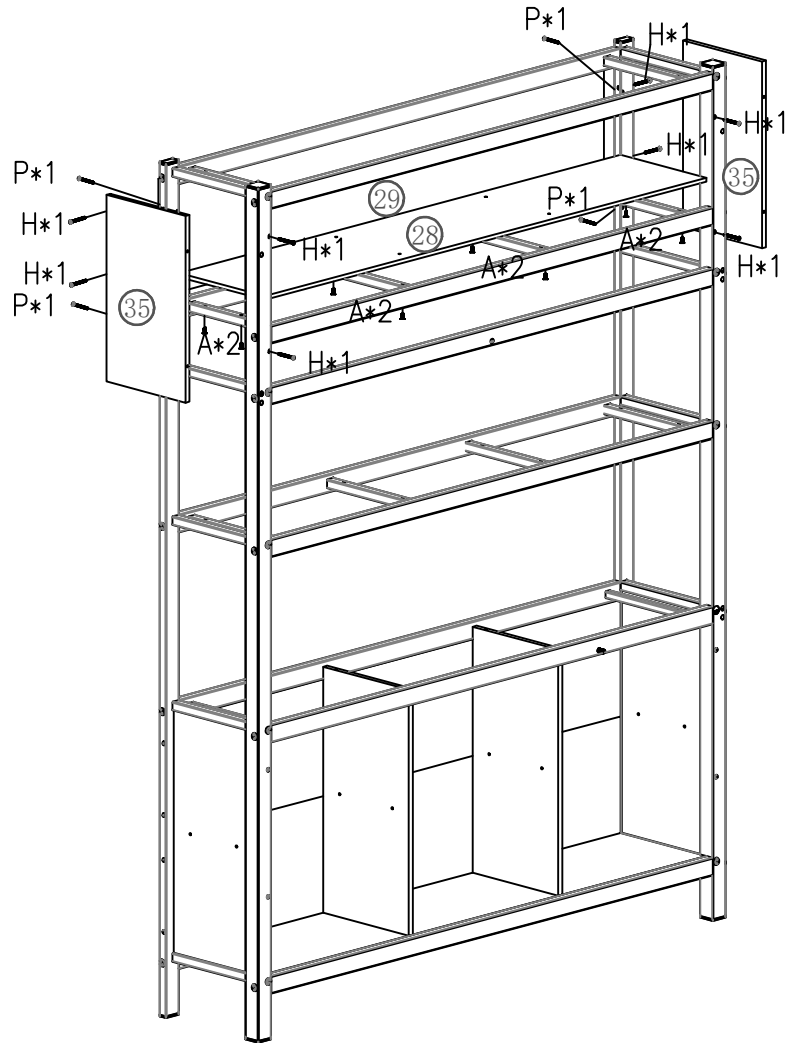

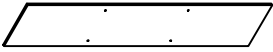

						
28-1pcs	31-2pcs	A	G	H	P	L
		4*8	4*25	4*50	4*35	
29-2pcs	32-2pcs	8PCS	4PCS	12PCS	4PCS	

Step 5: Use hardware L,A,G,H to connect #28,#29 and #35 to the previously installed components.

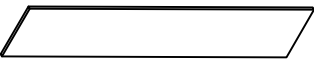
Step 6: Use hardware L,A,G to connect #28 and #36 to the previously installed components.

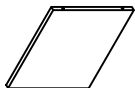

					
28-1pcs		A	H	P	
	35-2pcs	4*8 8PCS	4*50 8PCS	4*35 4PCS	
29-1pcs					





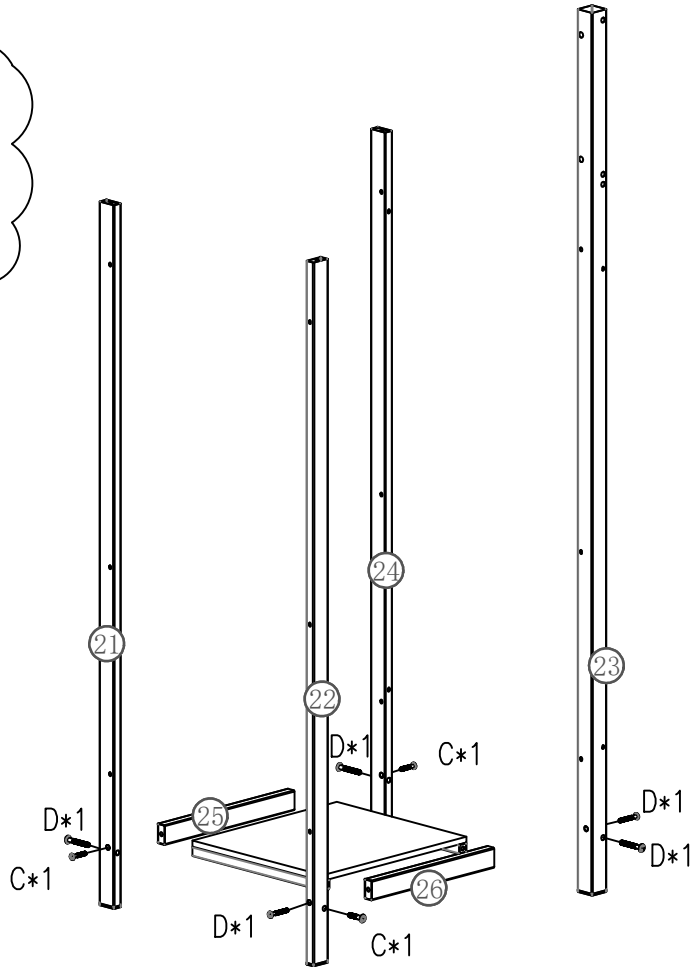
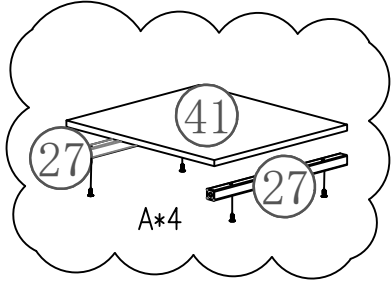



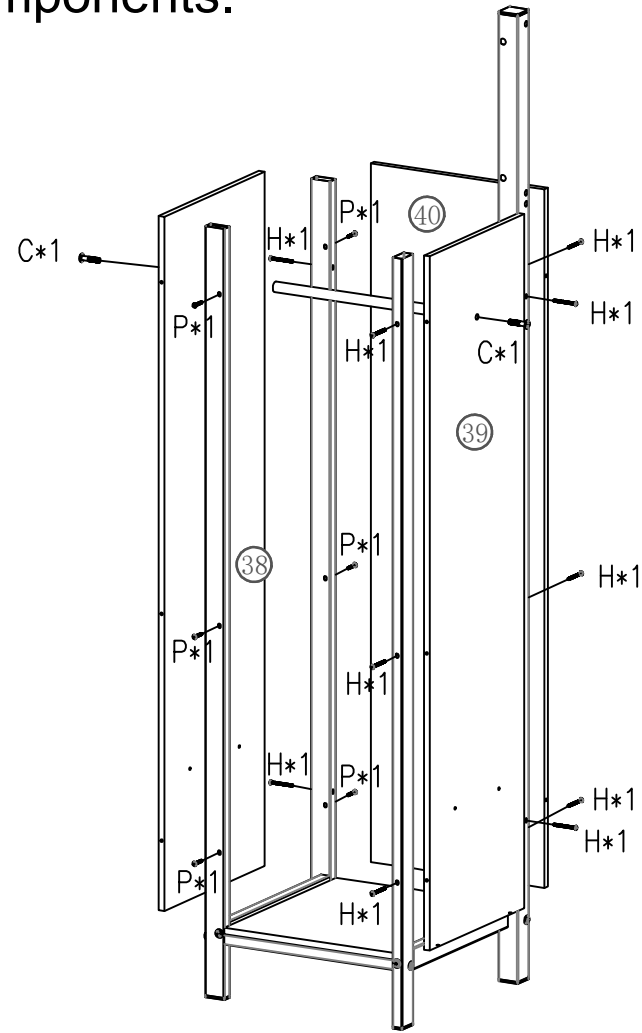

				
28-1pcs		A	G	
	36-2pcs	4*8 4PCS	4*25 8PCS	

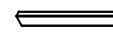
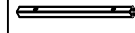





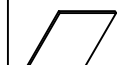

Step 7: Use hardware L,N,A,C,D to connect #21 ,#22,#23,#24,#25,#26,#27 and #41 to the previously installed components.

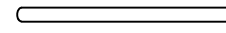

Step 8: Use hardware L,D,G,H to connect #20,#38,#39,#40 to the previously installed components.



								
21-1pcs	23-1pcs	25-1pcs	27-2pcs	A	C	D	L	N
				4*8 4PCS	8*35 3PCS	8*55 5PCS	L	N
22-1pcs	24-1pcs	26-1pcs	41-1pcs					

						
20-1pcs	39-1pcs	C	P	H	L	N
		8*35 2PCS	4*35 6PCS	4*50 10PCS	L	N
38-1pcs	40-1pcs					

Step 9: Use hardware N ,E, D to connect #10 and #12 together.

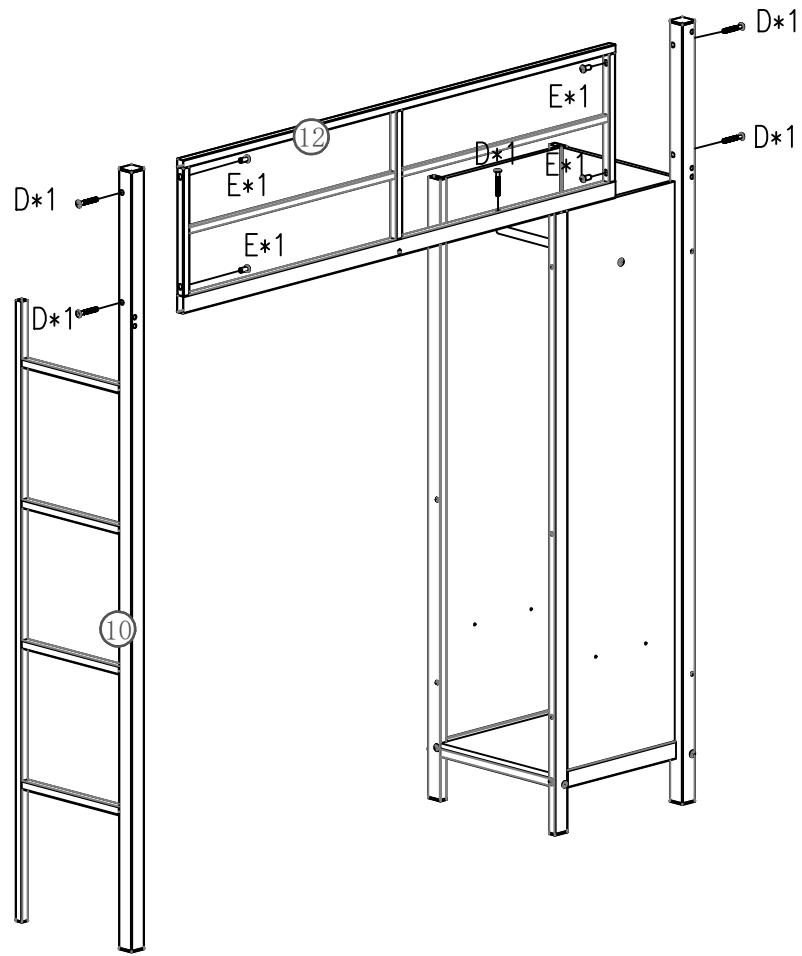

Step 10: Use hardware N,B,C,D to connect #17 and #18 to the previously installed components.

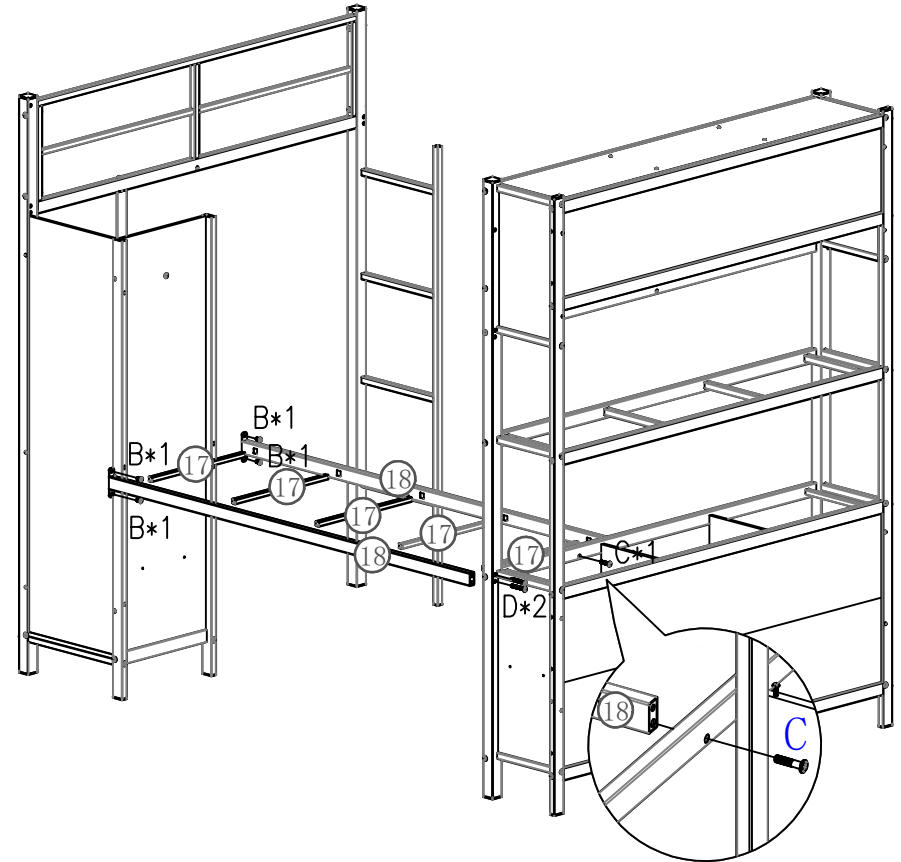

10-1pcs



12-1pcs



E
8*15
4PCS



D
8*55
5PCS



N



18-2cs

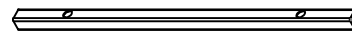

17-5pcs



B
8*15
4PCS



C
8*35
1PCS



D
8*55
2PCS



N

Step 11: Use hardware N C,D to connect #13 and #14 to the previously installed components.

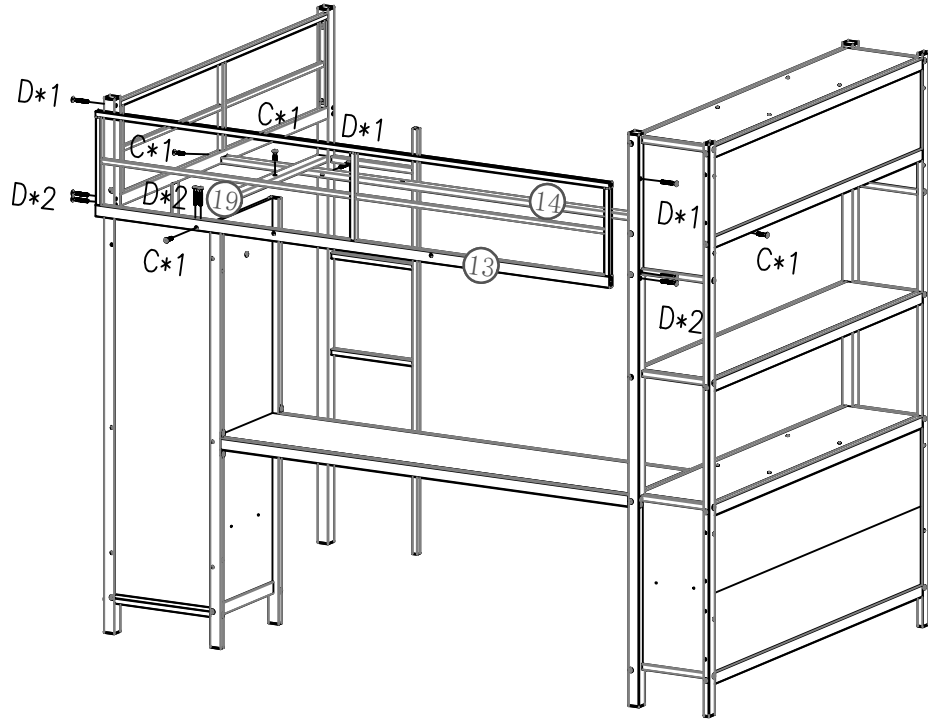

Step 12: Use hardware L,A,G to connect #30, #37, #40 and #46 to the previously installed components.

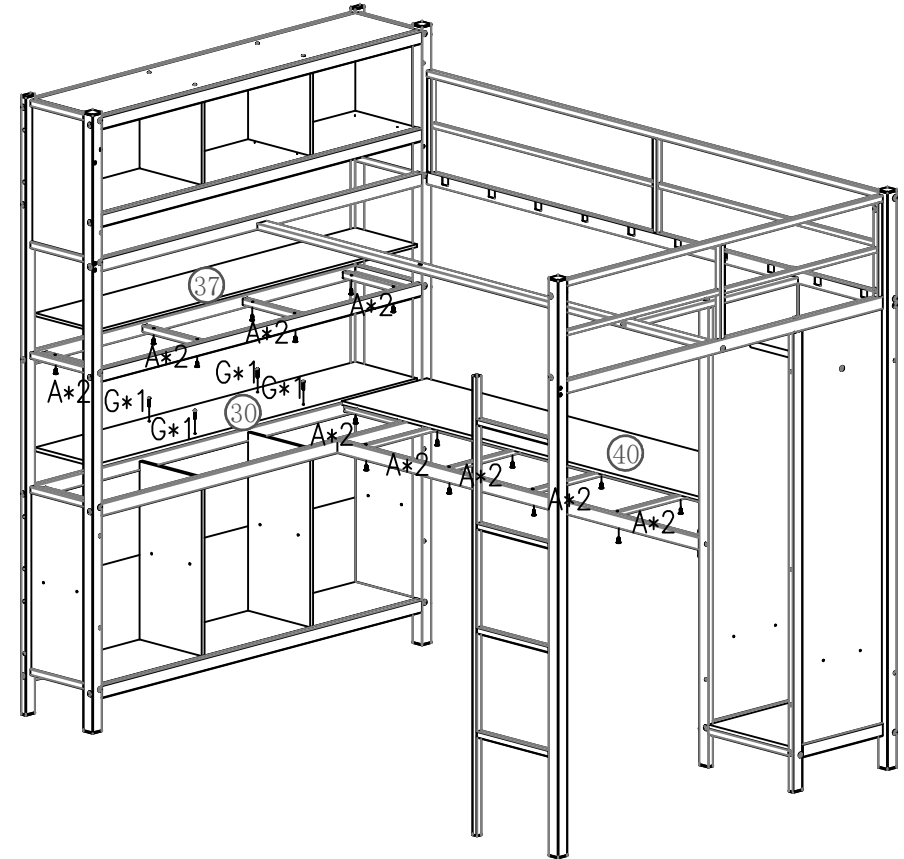

13-1pcs



14-1pcs

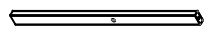

19-1pcs



C

8*35
4PCS



D

8*55
9PCS



N

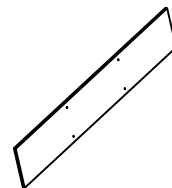

30-1pcs

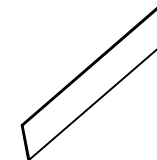

37-1pcs

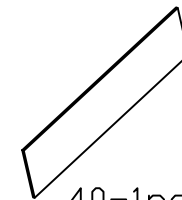

40-1pcs



A

4*8
22PCS



G

4*25
4PCS



L

Step 13: Use hardware N,I,B,C,D to connect #11,#15 and #16 to the previously installed components.

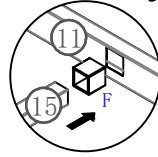



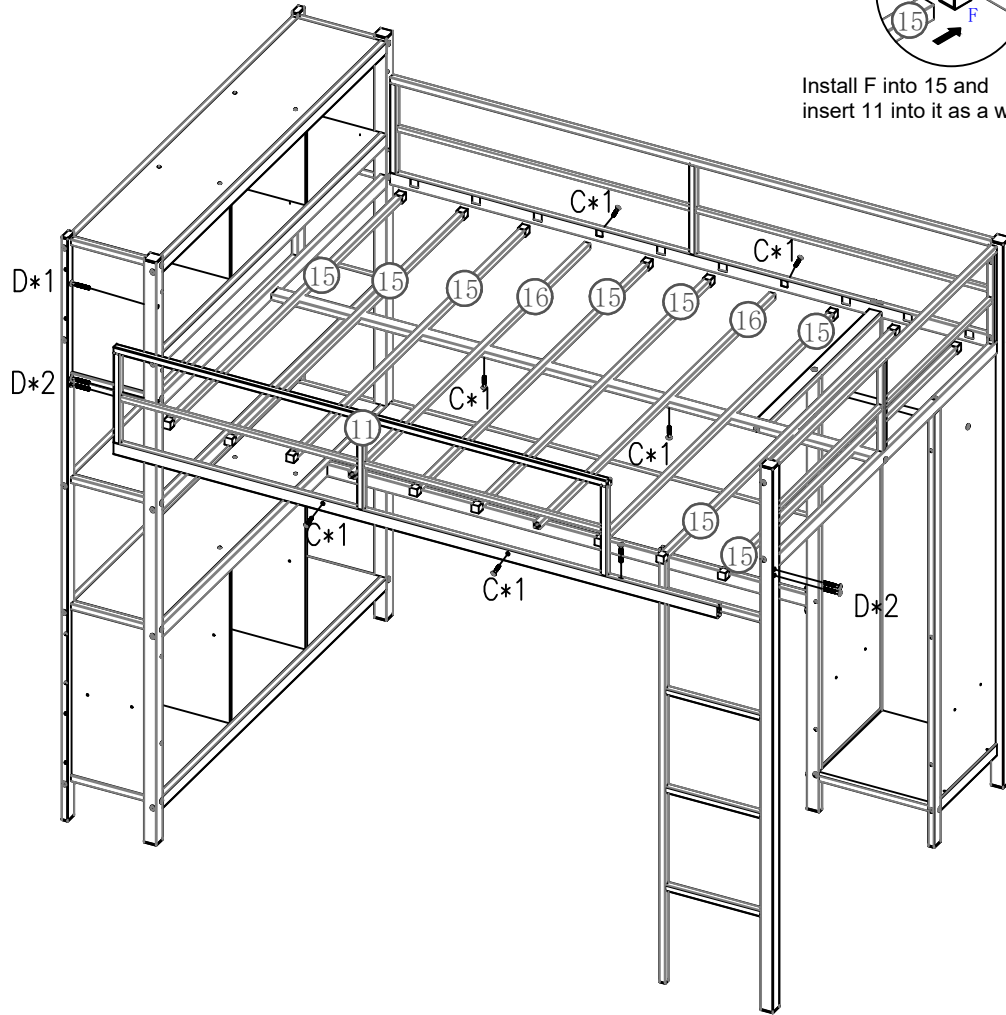



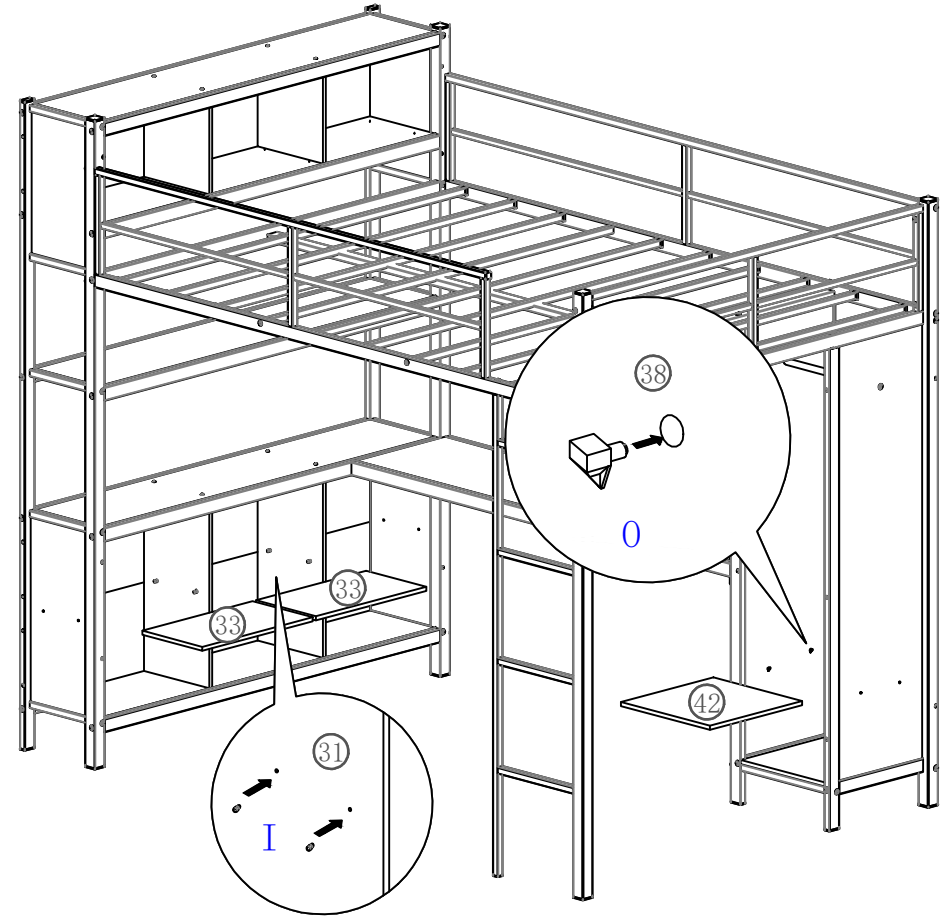

Install F into 15 and insert 11 into it as a whole



Step 14: Use hardware F to connect #33 and #42 to the previously installed components.

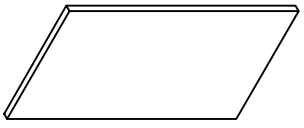
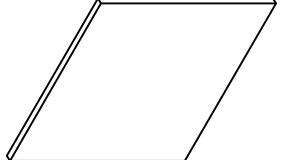
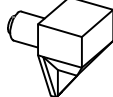

									
15-8pcs		C	D	F	N			O	I
16-2pcs	11-1pcs	8*35 6PCS	8*55 5PCS	16PCS		33-2pcs	42-1pcs	5*10-4PCS	5*10-8PCS