

ASSEMBLY INSTRUCTION

SKU CODE: (BW00056)

PAGE 1 OF 34

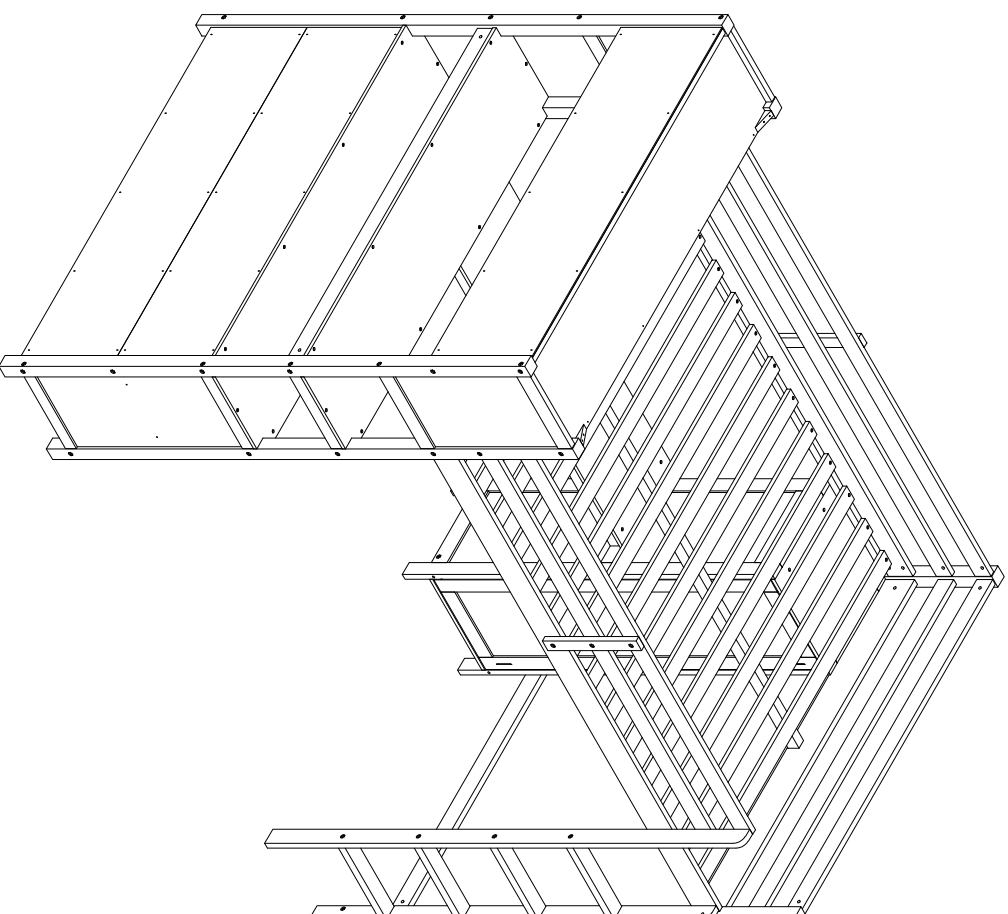

IMPORTANT NOTE

1. PLACE ALL PARTS ON A CLEAN AND SMOOTH SURFACE SUCH AS A RUG OR CARPET TO AVOID THE PARTS FROM BEING SCRATCHED
2. BEFORE YOU BEGIN, KINDLY FOLLOW THE ASSEMBLY INSTRUCTIONS STEP BY STEP
3. DO NOT TIGHTEN ALL SCREWS AND BOLTS UNTIL THE BED IS FULLY SET-UP

! SAFETY WARNINGS ! PAGE 2 OF 34

1. This bed is designed for use only mattress (es) meeting the following specifications on the upper bunk



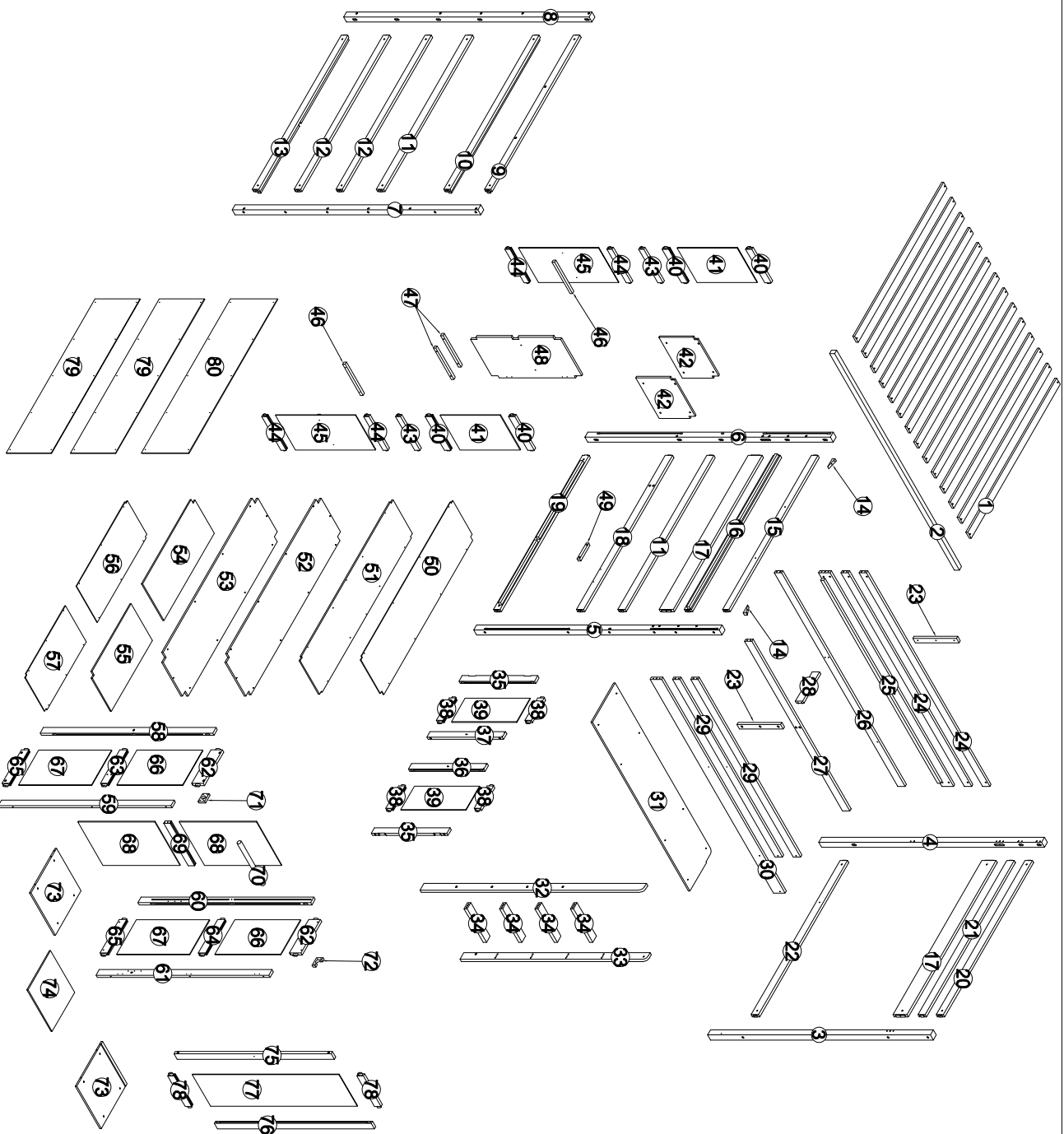

Upper bunk bed

Bed Type	Length	Width	Thickness
Full Standard	74" - 75"	53 1/2"	6" max



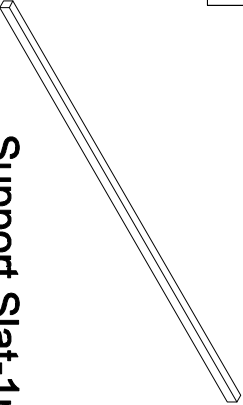

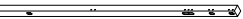
2. Replacement parts, including additional guardrails, maybe obtained from any of our (YEUK FUNG GQ INTERNATIONAL LIMITED FLAT/RM 1602, 16/F MULTFIELD COMMERCIAL CENTRE, 426 SHANGHAI STREET MONGKOK KL) dealers
3. Follow the information on the warnings appearing on the upper bunk bed end structure and on the carton. Do not remove warning label from bed
4. Always use the recommended size mattresses or mattress supports, or both, to help prevent the likelihood of entrapment or falls.
5. Surface of mattress must be at least 5" (127mm) below the upper edge of guardrails
6. Do not allow children under 6 years of age to use the upper bunk.
7. Periodically check and ensure that the guardrail, ladder, and other components are in their proper position, free from damage, and that all connectors are tight.
8. Do not allow horseplay on or under the bed and prohibit jumping on the bed.
9. Always use the ladder for entering and leaving the upper bunk. Always use the ladder for entering and leaving the upper bunk.
10. Do not use substitute part. Contact the manufacture or dealer for replacement part
11. Use of a night light may provide added safety precaution for a child using the upper bunk..
12. Always use guardrails on both long sides of the upper bunk. If the bunk bed will be placed next to the wall, the guardrail that runs the full length of the bed should be placed against the wall to prevent entrapment between the bed and wall.
13. The use of water or sleep flotation mattresses is prohibited
14. STRANGULATION HAZARD - Never attach or hang items to any part of the bunk bed that are not designed for use with the bed; for example, but not limited to, hook, belts and jump ropes
15. Keep these instruction for future reference
16. Prohibit more than one person on upper bunk
17. We recommend assembling your bunk bed on the shipping carton to protect your floor or carpet
18. Be certain all staples are out of the box before beginning assembly on the shipping carton.

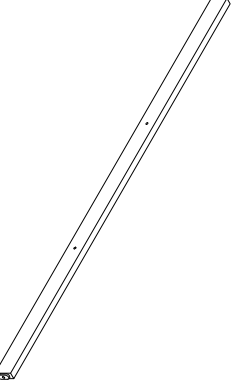
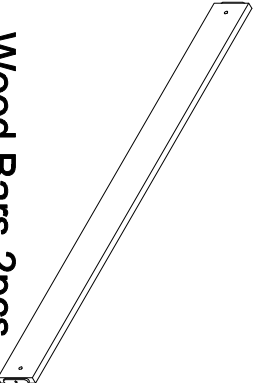
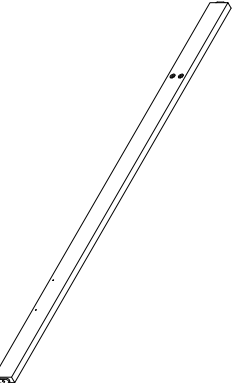



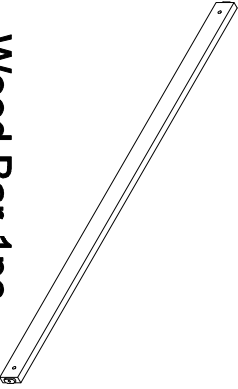
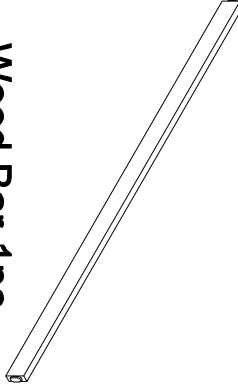
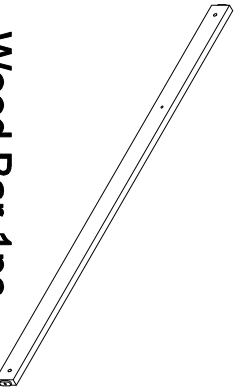

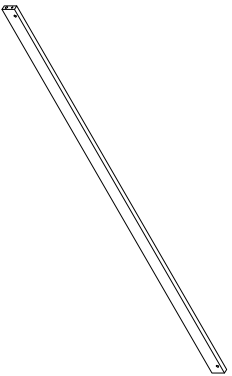
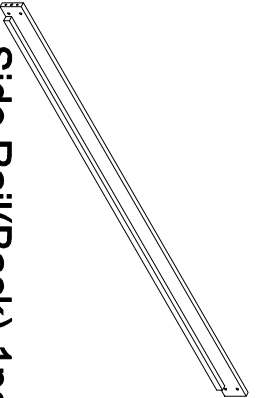
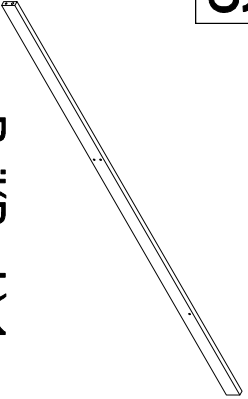
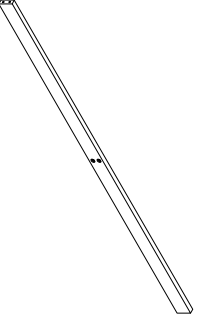
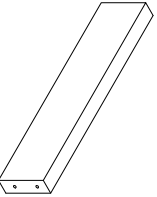
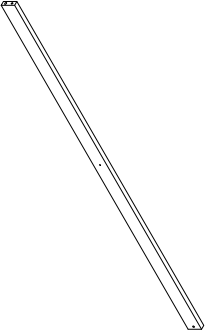
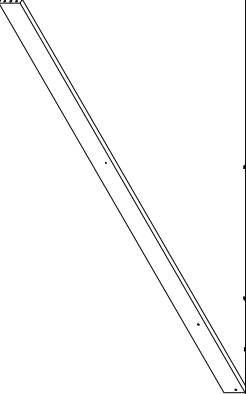
Box 1:W00056-1(PART LIST & HW LIST)

<p>2</p>  <p>Support Slat-1pc</p>	<p>3</p>  <p>Leg-1pc</p>	<p>4</p>  <p>Leg-1pc</p>
<p>5</p> <p>Support Slat-1pc</p>	<p>6</p>  <p>Leg-1pc</p>	<p>7</p>  <p>Leg-1pc</p>
<p>8</p> <p>Leg-1pc</p>	<p>11</p> <p>Leg-1pc</p>	<p>12</p> <p>Leg-1pc</p>
<p>15</p> <p>Leg-1pc</p>	<p>17</p> <p>Wood Bars-2pcs</p>	<p>18</p> <p>Wood Bars-2pcs</p>
<p>15</p>  <p>Wood Bar-1pc</p>	<p>17</p>  <p>Wood Bars-2pcs</p>	<p>18</p>  <p>Wood Bar-1pc</p>

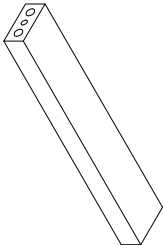
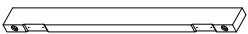
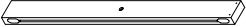
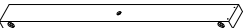
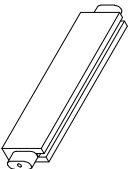

Box 1:W00056-1(PART LIST & HW LIST)

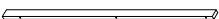
<p>20</p>  <p>Wood Bar-1pc</p>	<p>21</p>  <p>Wood Bar-1pc</p>	<p>22</p>  <p>Wood Bar-1pc</p>
<p>23</p>  <p>Wood Bar-1pc</p>	<p>24</p>  <p>Wood Bar-1pc</p>	<p>25</p>  <p>Wood Bar-1pc</p>
<p>Support Side Rails-2pcs</p>		
<p>26</p>  <p>Rail(Back)-1pc</p>	<p>27</p>  <p>Guard Rails(Back)-2pcs</p>	<p>28</p>  <p>Side Rail(Back)-1pc</p>
<p>Rail(Center)-1pc</p>		
<p>29</p>  <p>Guard Rails(Front)-2pcs</p>	<p>30</p>  <p>Side Rail(Front)-1pc</p>	<p>32</p>  <p>Side Ladder-1pc</p>

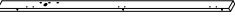
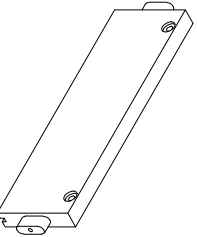
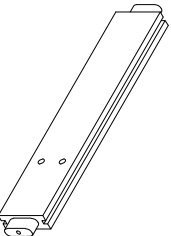
Box 1:W00056-1(PART LIST & HW LIST)

<p>33</p>  <p>Side Ladder-1pc</p>	<p>34</p>  <p>Step Ladders-4pcs</p>	<p>35</p>  <p>Door-Wood Bars-2pcs</p>
<p>36</p>  <p>Door-Wood Bar-1pc</p>	<p>37</p>  <p>Door-Wood Bar-1pc</p>	<p>38</p>  <p>Door-Wood Bars-4pcs</p>
<p>58</p>  <p>Wood Bar-1pc</p>	<p>59</p>  <p>Wood Bar-1pc</p>	<p>60</p>  <p>Wood Bar-1pc</p>
<p>61</p>  <p>Wood Bar-1pc</p>	<p>62</p>  <p>Wood Bars-2pcs</p>	<p>63</p>  <p>Wood Bar-1pc</p>

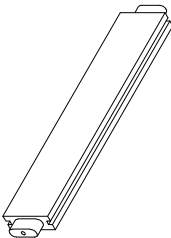
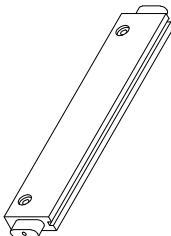
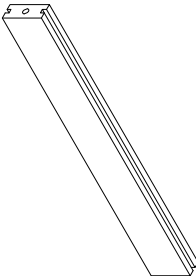
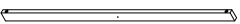

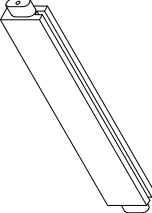
Box 1:W00056-1(PART LIST & HW LIST)

<p>64</p>  <p>Wood Bar-1pc</p>	<p>65</p>  <p>Wood Bars-2pcs</p>	<p>69</p>  <p>Wood Bar-1pc</p>
<p>75</p>  <p>Wood bar-1pc</p>	<p>76</p>  <p>Wood bar-1pc</p>	<p>78</p>  <p>Wood bars-2pcs</p>

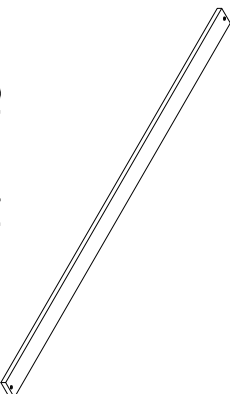
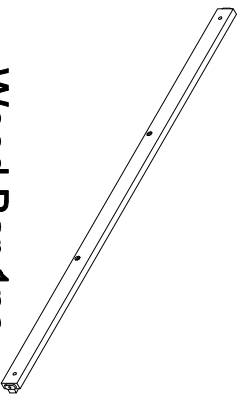
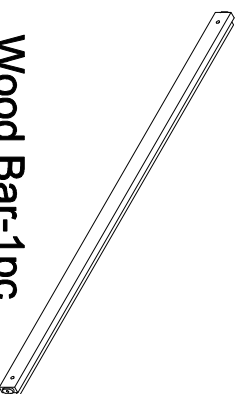
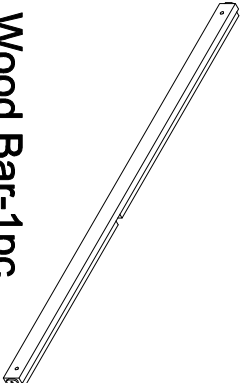
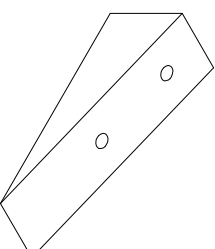
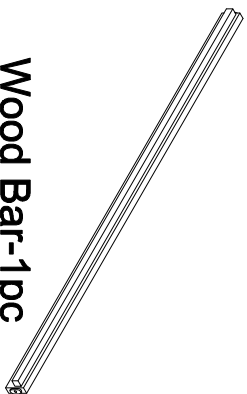
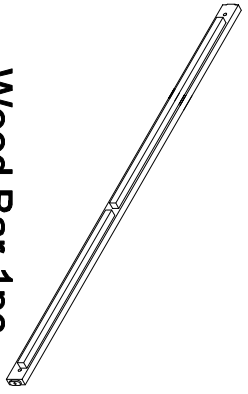
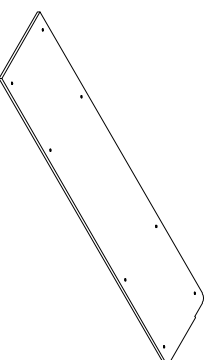
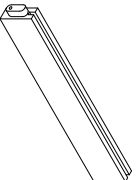
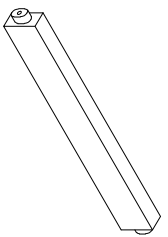
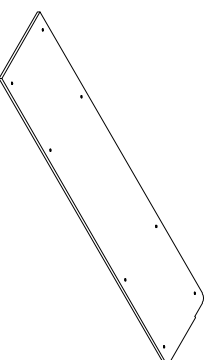
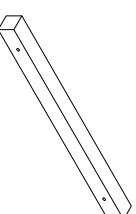
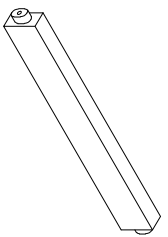
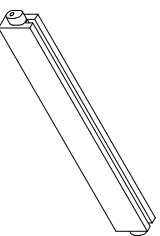
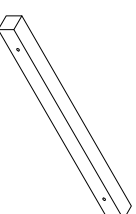
Box 2:W00056-2



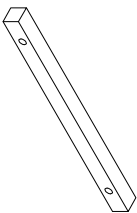
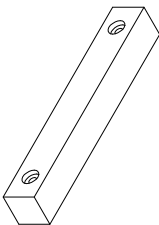
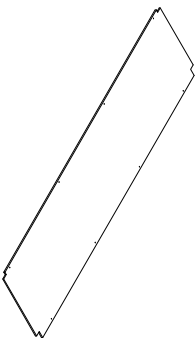
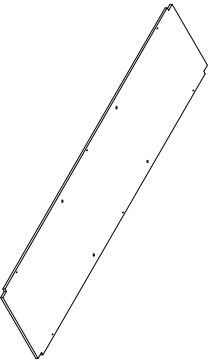
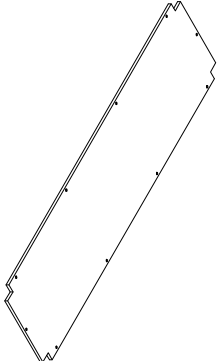
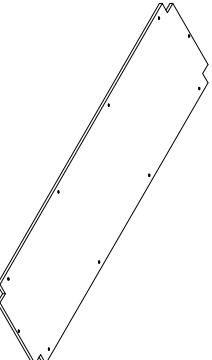
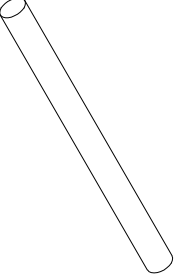
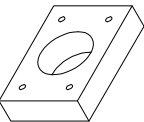
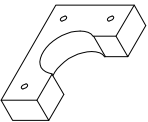
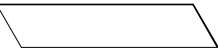
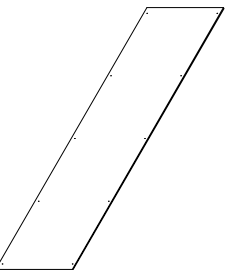

1  Wood Bar-1pc	9  Wood Bar-1pc	10  Wood Bar-1pc
13  Slats-14pcs	14  Wood Bar-1pc	16  Wood Bar-1pc
19  Wood Bar-1pc	31  Wood beetles-2pcs	40  Wood Bar-1pc
43  Wood bars-2pcs	44  Table panel-1pc	46  Wood bars-4pcs
43  Wood bars-2pcs	44  Wood bars-4pcs	46  Wood beetles-2pcs

Box 2:W00056-2

<p>47</p>  <p>Wood beetles-2pcs</p>	<p>49</p>  <p>Wood beetle-1pc</p>	<p>50</p>  <p>Panel-1pc</p>
<p>51</p>  <p>Panel-1pc</p>	<p>52</p>  <p>Panel-1pc</p>	<p>53</p>  <p>Panel-1pc</p>
<p>70</p>  <p>Clother Bar-1pc</p>	<p>71</p>  <p>Wood beetle-1pc</p>	<p>72</p>  <p>Wood beetle-1pc</p>
<p>77</p>  <p>Panel-1pc</p>	<p>79</p>  <p>Panels-2pcs</p>	<p>80</p>  <p>Panel-1pc</p>

ASSEMBLY INSTRUCTION PAGE 10 OF 34

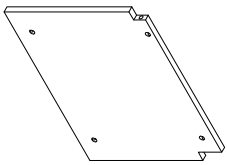
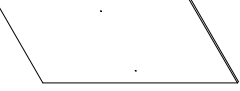
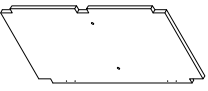
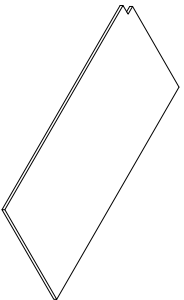
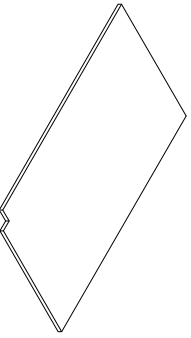
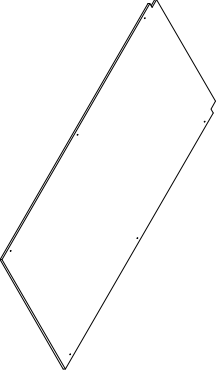
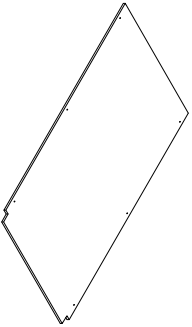
Box 3:W00056-3

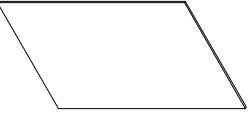
<p>39</p>  <p>Door-Panels-2pcs</p>	<p>41</p>  <p>Panels-2pcs</p>	<p>42</p>  <p>Center Panels-2pcs</p>
<p>45</p>  <p>Panels-2pcs</p>	<p>48</p>  <p>Center Panel-1pc</p>	<p>54</p>  <p>Panel-1pc</p>
<p>55</p>  <p>Panel-1pc</p>	<p>56</p>  <p>Panel-1pc</p>	<p>57</p>  <p>Panel-1pc</p>
<p>66</p>  <p>Panels-2pcs</p>	<p>67</p>  <p>Panels-2pcs</p>	<p>68</p>  <p>Panels-2pcs</p>

Box 3:W00056-3

73

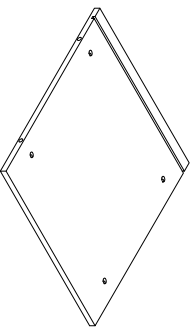

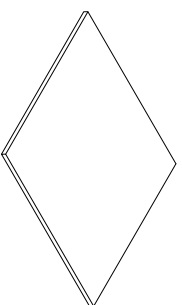

Panels-2pcs

74





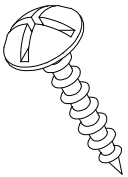
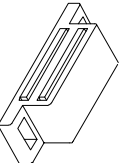
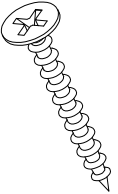
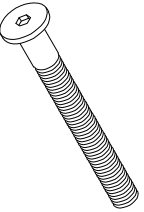
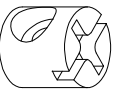

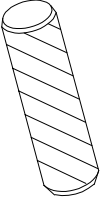
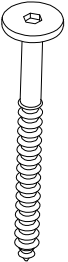
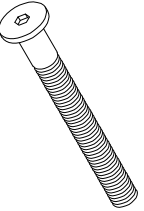
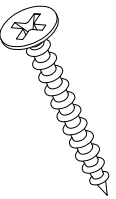
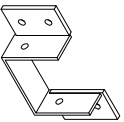
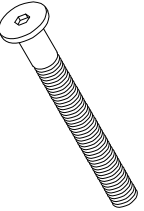

Remove Panel-1pc

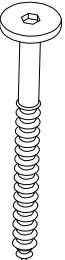
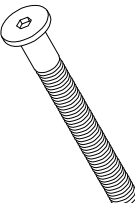
HARDWARE LIST (Box 1:W00056-1)

<p align="center">A</p>  <p align="center">M4 x15 mm Wood Screws 64pcs</p>	<p align="center">B</p>  <p align="center">Door Catches(45x17x13) 3pcs</p>	<p align="center">C</p>  <p align="center">M4 x 30 mm Wood Screws 39pcs</p>
<p align="center">D</p>  <p align="center">Ø1/4" x 90 mm Hex-Head bolts 46pcs</p>	<p align="center">E</p>  <p align="center">Ø1/4" x 13 mm Horizontal-Hole bolts 82pcs</p>	<p align="center">F</p>  <p align="center">Screws 1/4" x 30 mm 6pcs</p>
<p align="center">G</p>  <p align="center">Ø10 x 40 mm Wood dowel 28pcs</p>	<p align="center">H</p>  <p align="center">Screws 1/4" x 50 mm 8pcs</p>	<p align="center">K</p>  <p align="center">Ø1/4" x 70 mm Hex-Head bolts 4pcs</p>
<p align="center">L</p>  <p align="center">M4 x 20 mm Wood Screws 46pcs</p>	<p align="center">M</p>  <p align="center">Steel Bracket 2pcs</p>	<p align="center">N</p>  <p align="center">Ø1/4" x 60 mm Hex-Head bolts 32pcs</p>

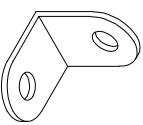
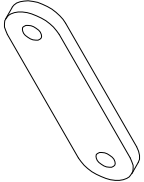
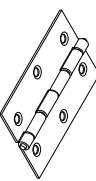
HARDWARE LIST (Box 1:W00056-1)

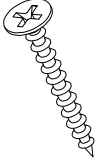
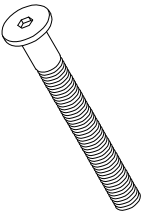
<p>P</p>  <p>Screws 1/4"x70 mm 20pcs</p>	<p>Q</p>  <p>Ø1/4" x 50 mm Hex-Head bolts 2pcs</p>	<p>R</p>  <p>Ø1/4" x 15 mm Canopy head through -3pcs</p>
<p>S</p>  <p>Screws 1/4"x80 mm 24pcs</p>	<p>T</p>  <p>Dowel Remove Shelves 4pcs</p>	<p>U</p>  <p>Steel Bracket 1pc</p>
<p>V</p>  <p>Magnet Inhaler -3pcs</p>	<p>X</p>  <p>Leaf hinge 7pcs</p>	<p>Y</p>  <p>Ø1/6" x 25 mm Hex-Head bolts 3pcs</p>
<p>Z</p>  <p>Handle Wood 3pcs</p>	<p>O</p>  <p>M3 x 12 mm Wood Screws 48pcs</p>	<p>W</p>  <p>Ø1/4" x 30 mm Hex-Head bolts 1pc</p>

HARDWARE LIST (Box 1:W00056-1)

1

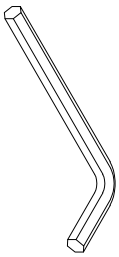



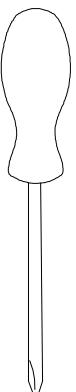



Allen Key 1pc

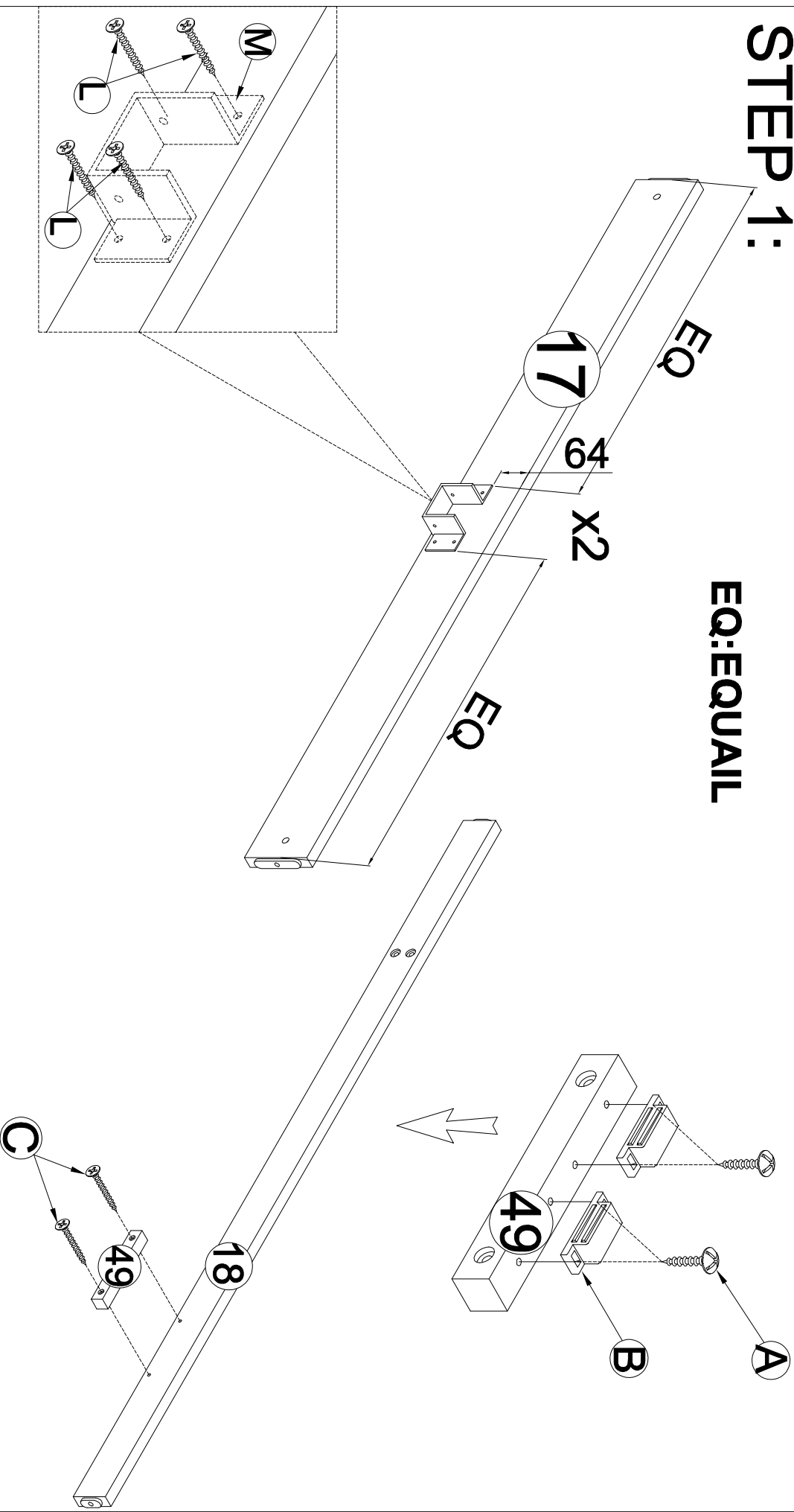

Assembly Tools Required (Not Included)

STEP 1: EQ:EQUAIL



<p>L</p>  <p>M4 x 20 mm Wood Screws 8pcs</p>	<p>M</p>  <p>Steel Bracket 2pcs</p>	<p>A</p>  <p>M4 x 15 mm Wood Screws 4pcs</p>	<p>B</p>  <p>Door Catches(45x17x13) 2pcs</p>	<p>C</p>  <p>M4 x 30 mm Wood Screws 2pcs</p>
--	---	--	--	--

STEP 2:

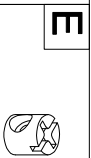
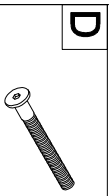
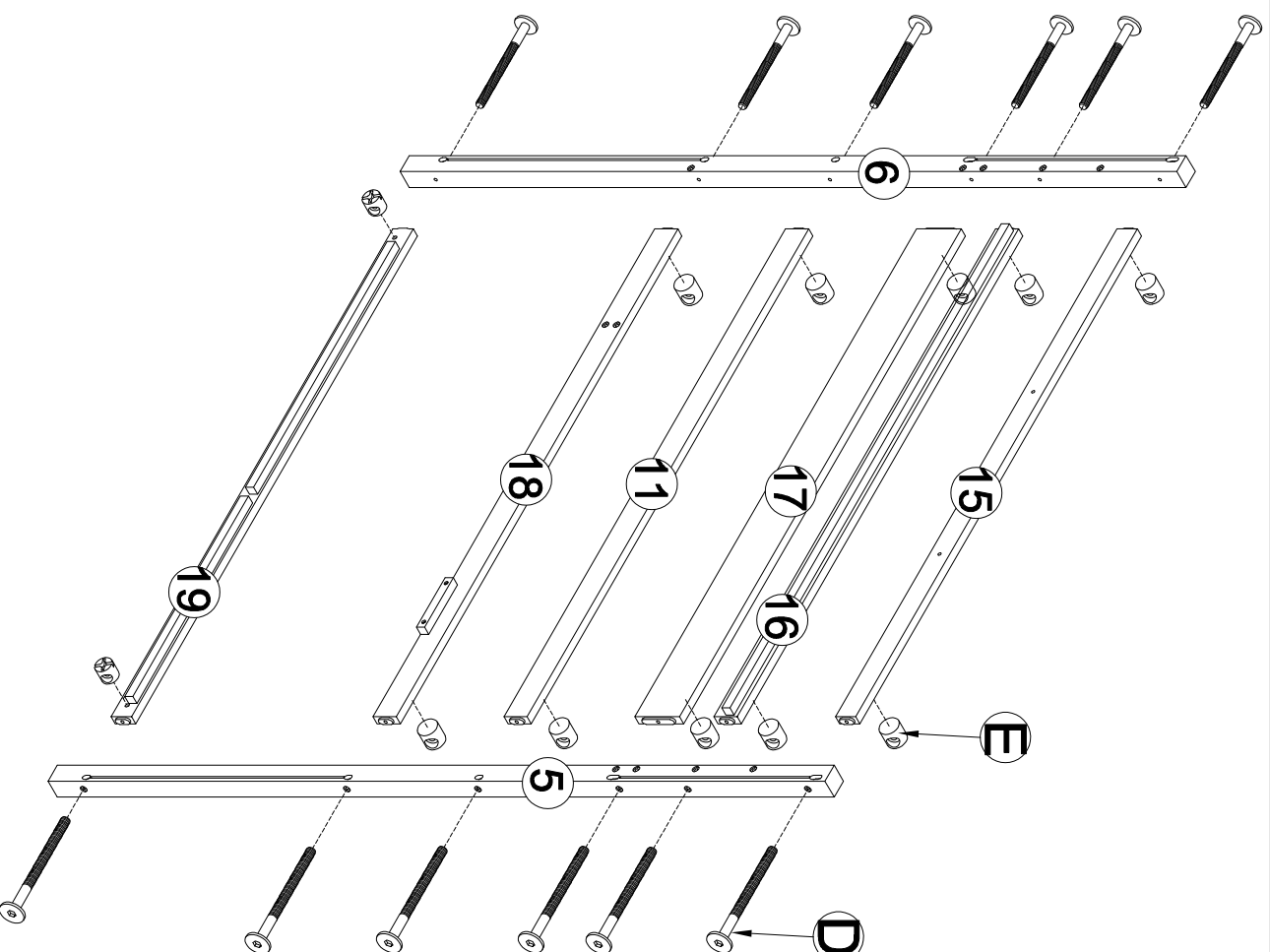

STEP 3:

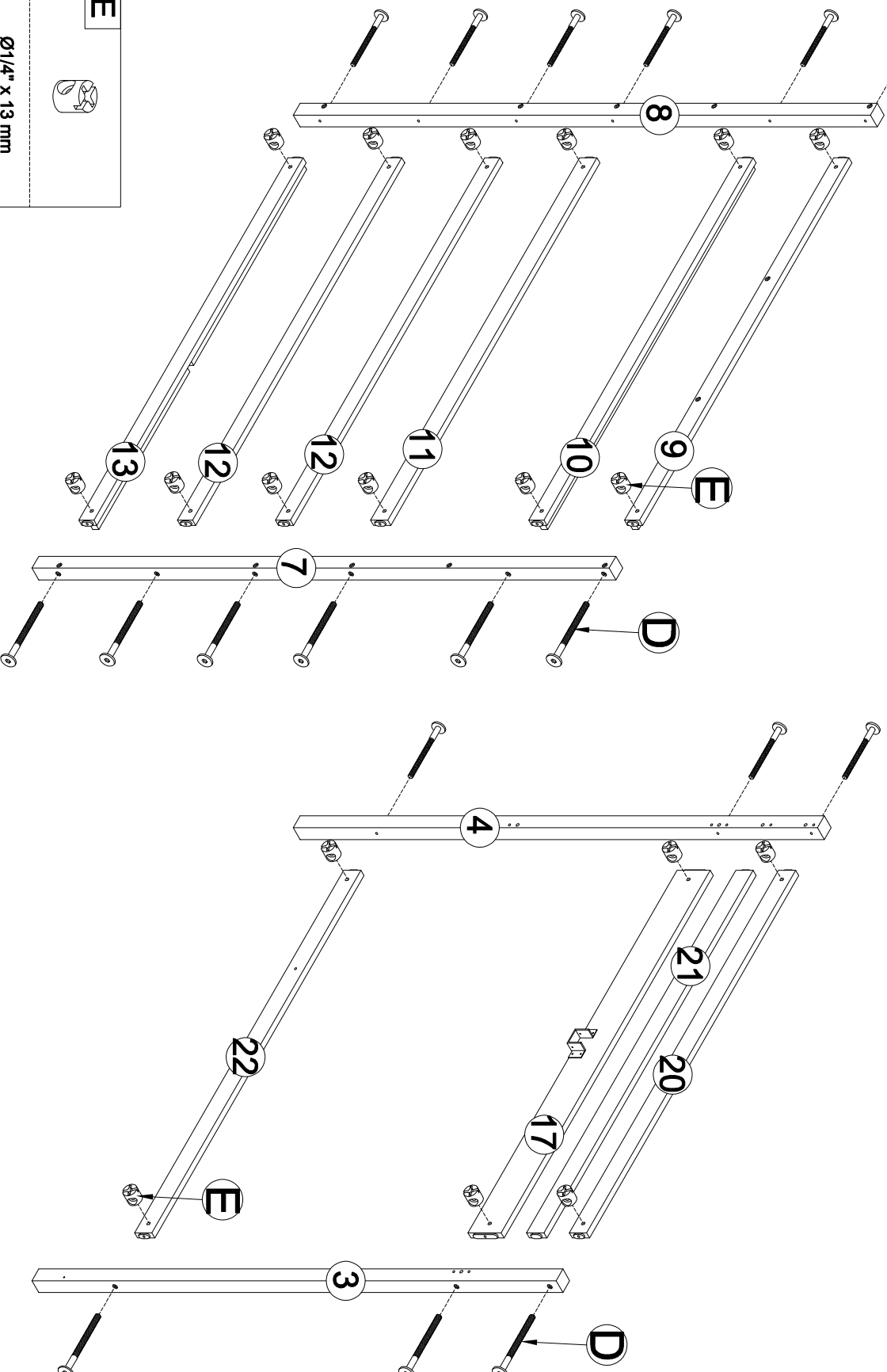

Ø1/4" x 90 mm
Hex-Head bolts 18pcs



Ø1/4" x 13 mm
Horizontal-Hole bolts 18pcs

STEP 4:

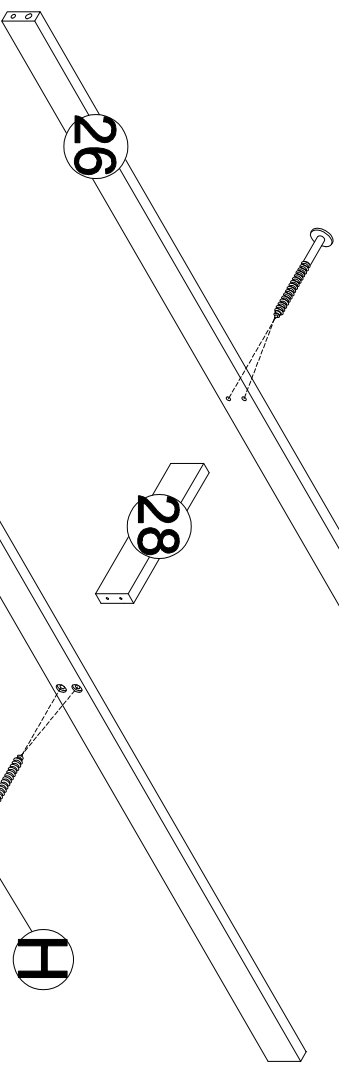
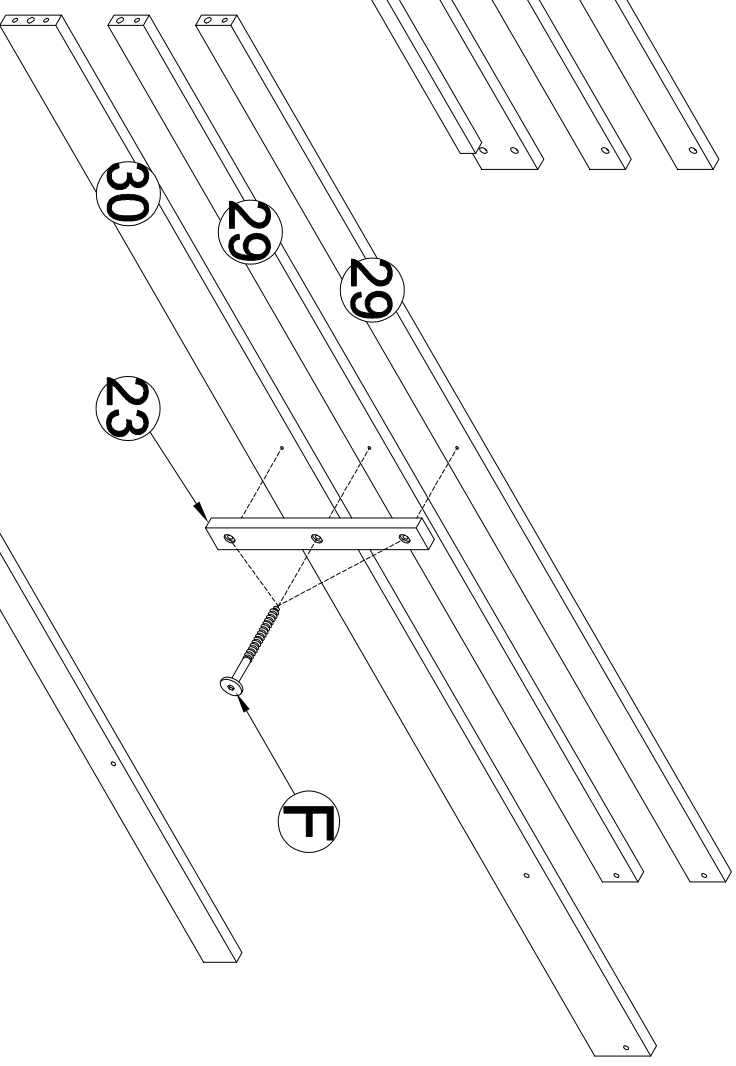
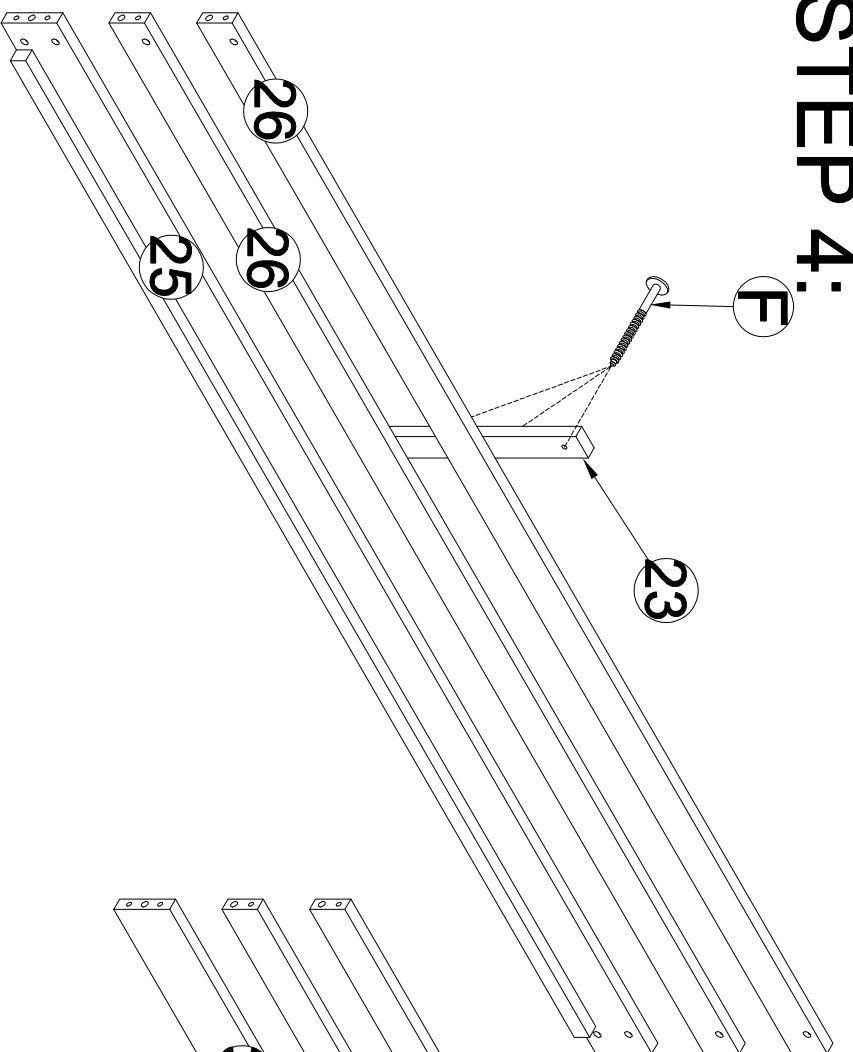

F	
H	

Screws 1/4"X30 mm
6pcs

Screws 1/4"X50 mm
4pcs

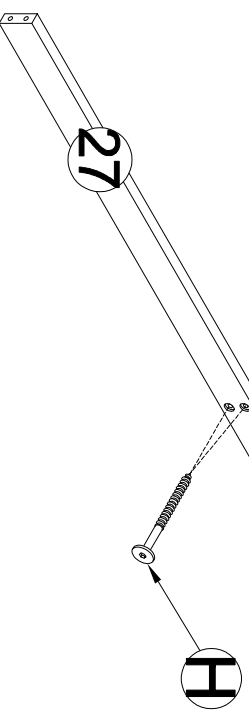

STEP 5:

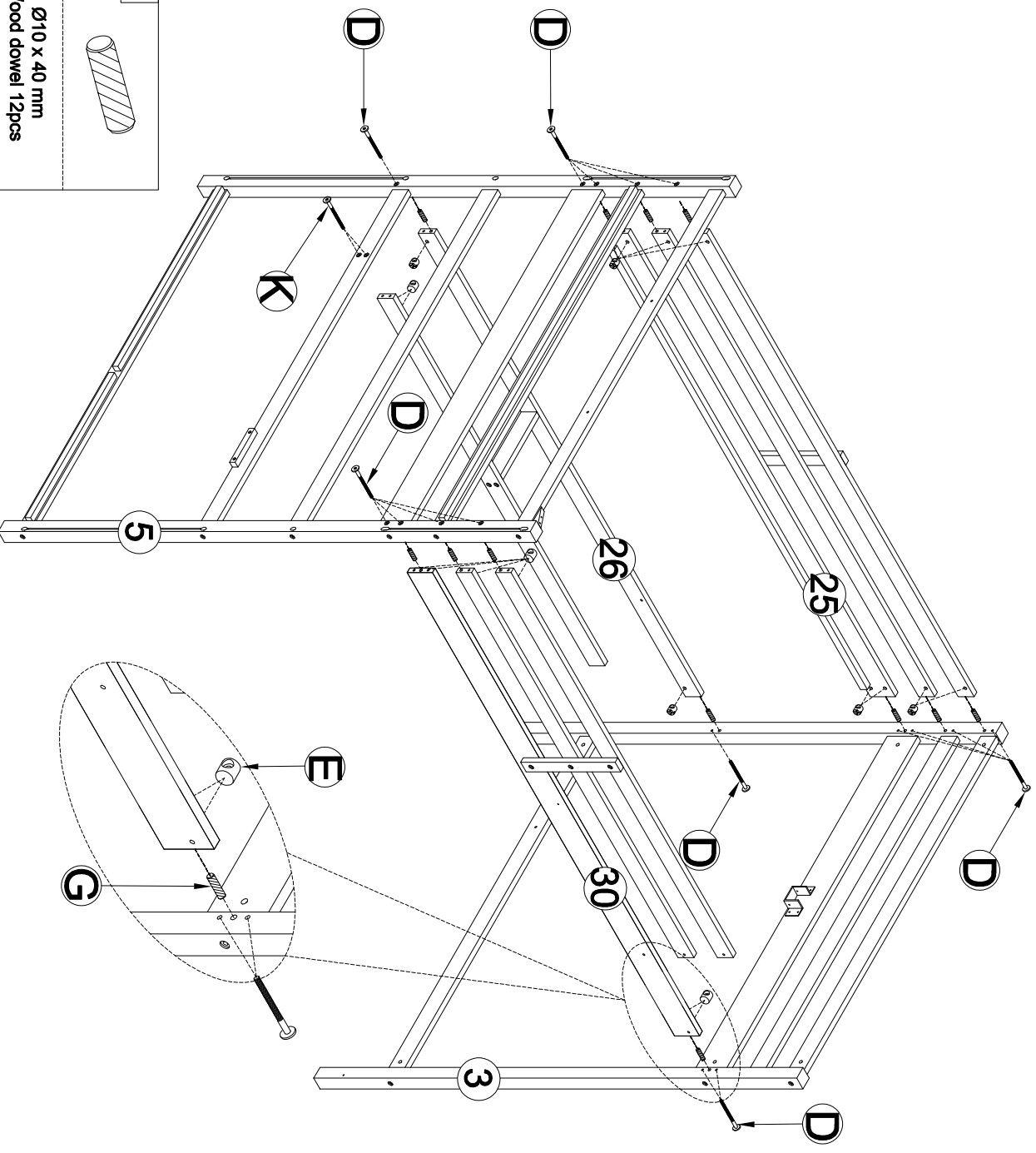

K
Ø1/4" x 70 mm
Hex-Head bolts 2pcs



D
Ø1/4" x 90 mm
Hex-Head bolts 16pcs



E
Ø1/4" x 13 mm
Horizontal-Hole bolts 18pcs







G
Ø10 x 40 mm
Wood dowel 12pcs

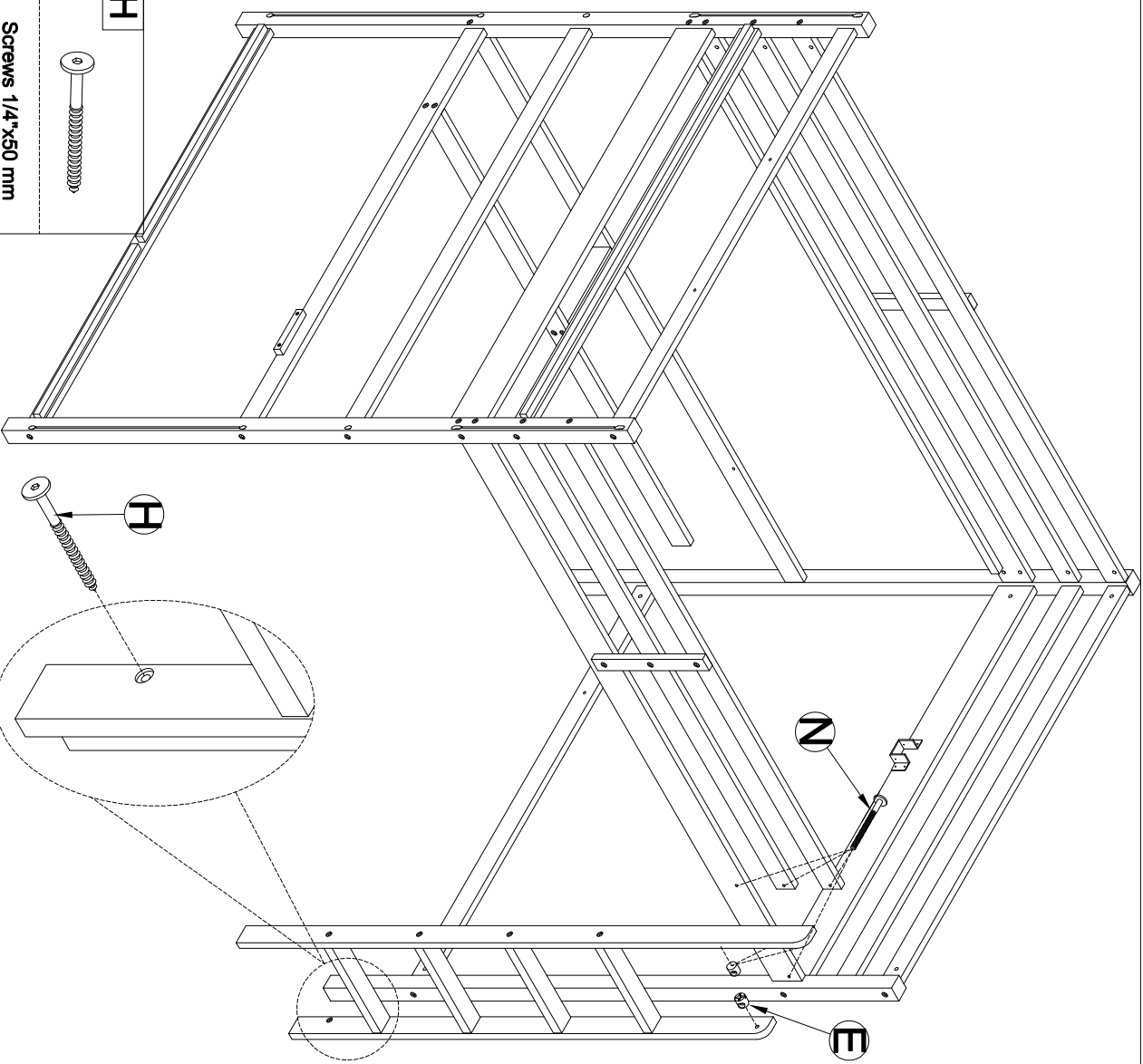
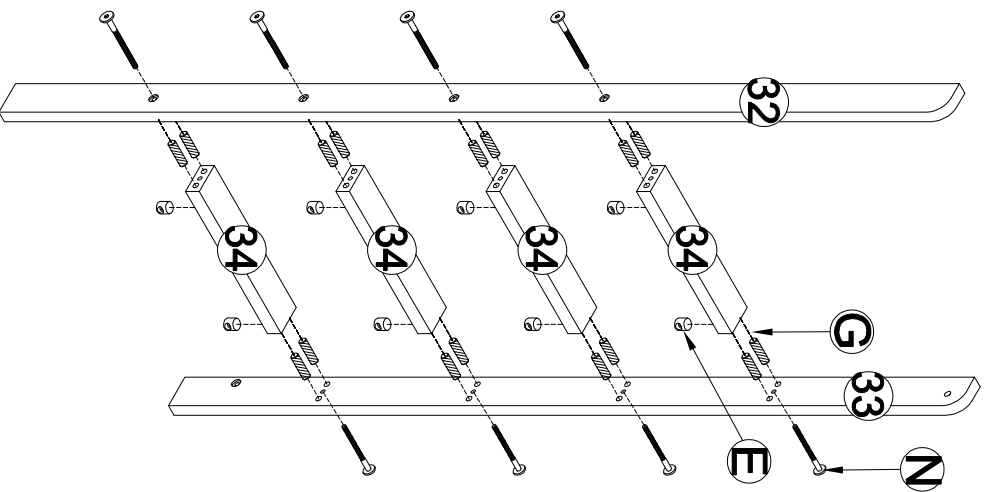

STEP 6:





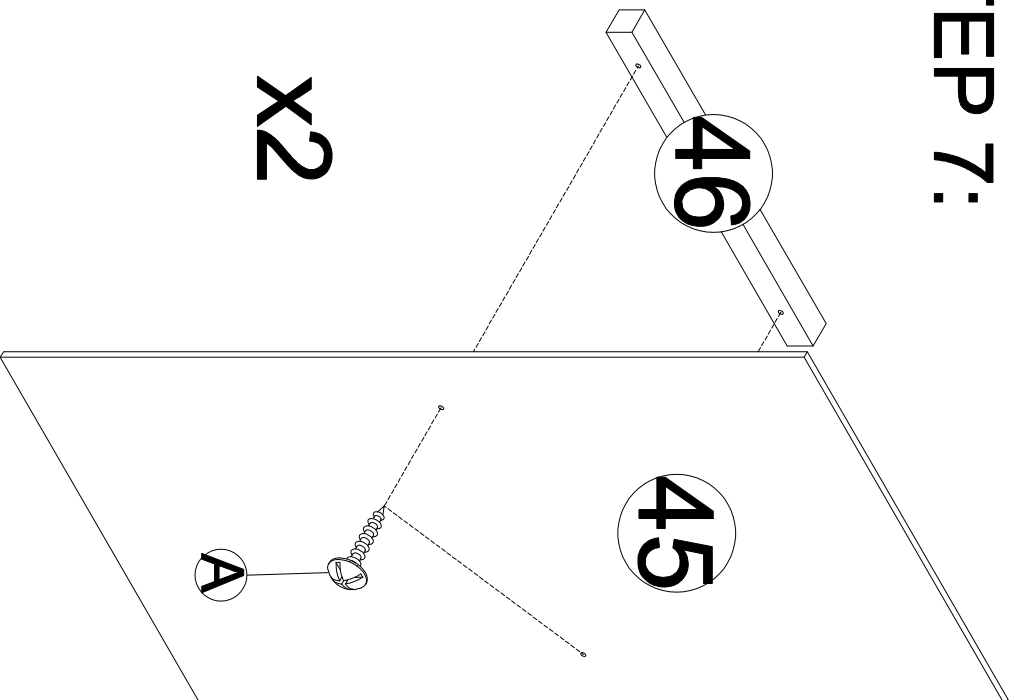

<p>N</p>  <p>Ø1/4" x 60 mm Hex-Head bolts 12pcs</p>	<p>E</p>  <p>Ø1/4" x 13 mm Horizontal-Hole bolts 12pcs</p>	<p>G</p>  <p>Ø10 x 40 mm Wood dowel 16pcs</p>	<p>H</p>  <p>Screws 1/4"x50 mm 1pc</p>
---	--	---	---

STEP 7:

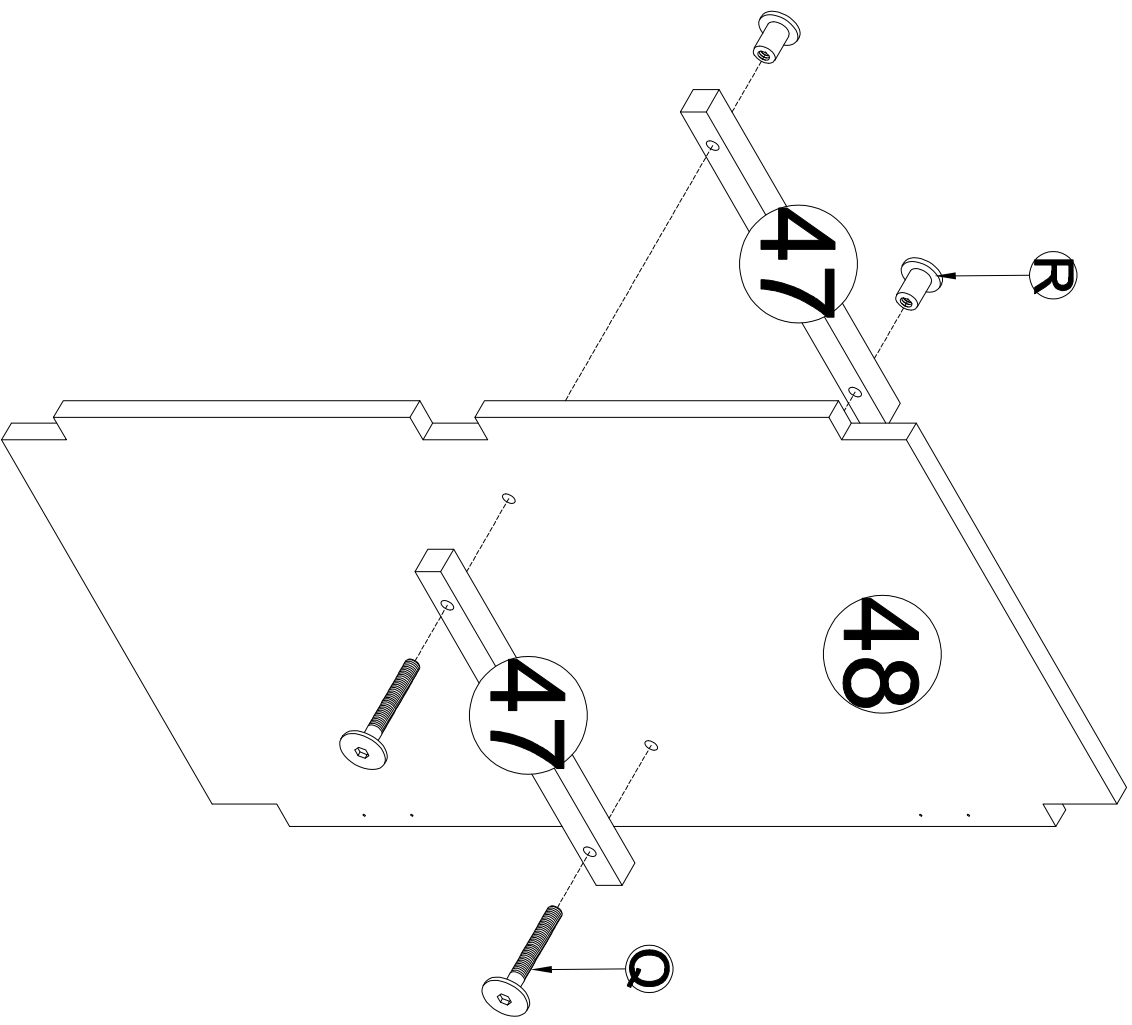

X2



A  M4 x15 mm Wood Screws 4pcs	Q  Ø1/4" x 50 mm Hex-Head bolts 2pcs	R  Ø1/4" x 15 mm Canopy head through -2pcs
--	---	---

STEP 8:

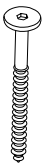
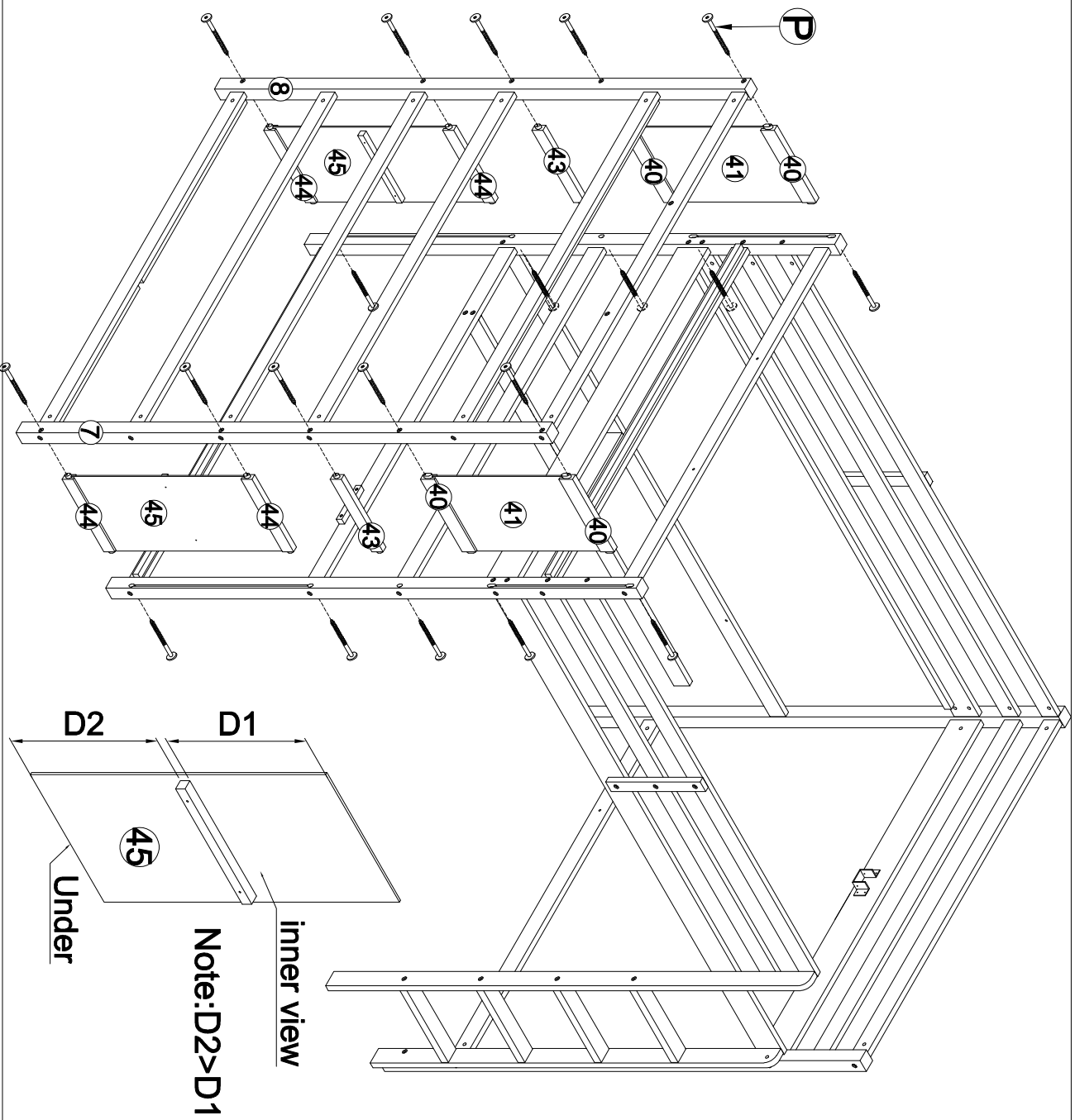

P

Screws 1/4"x70 mm
20pcs

STEP 9:

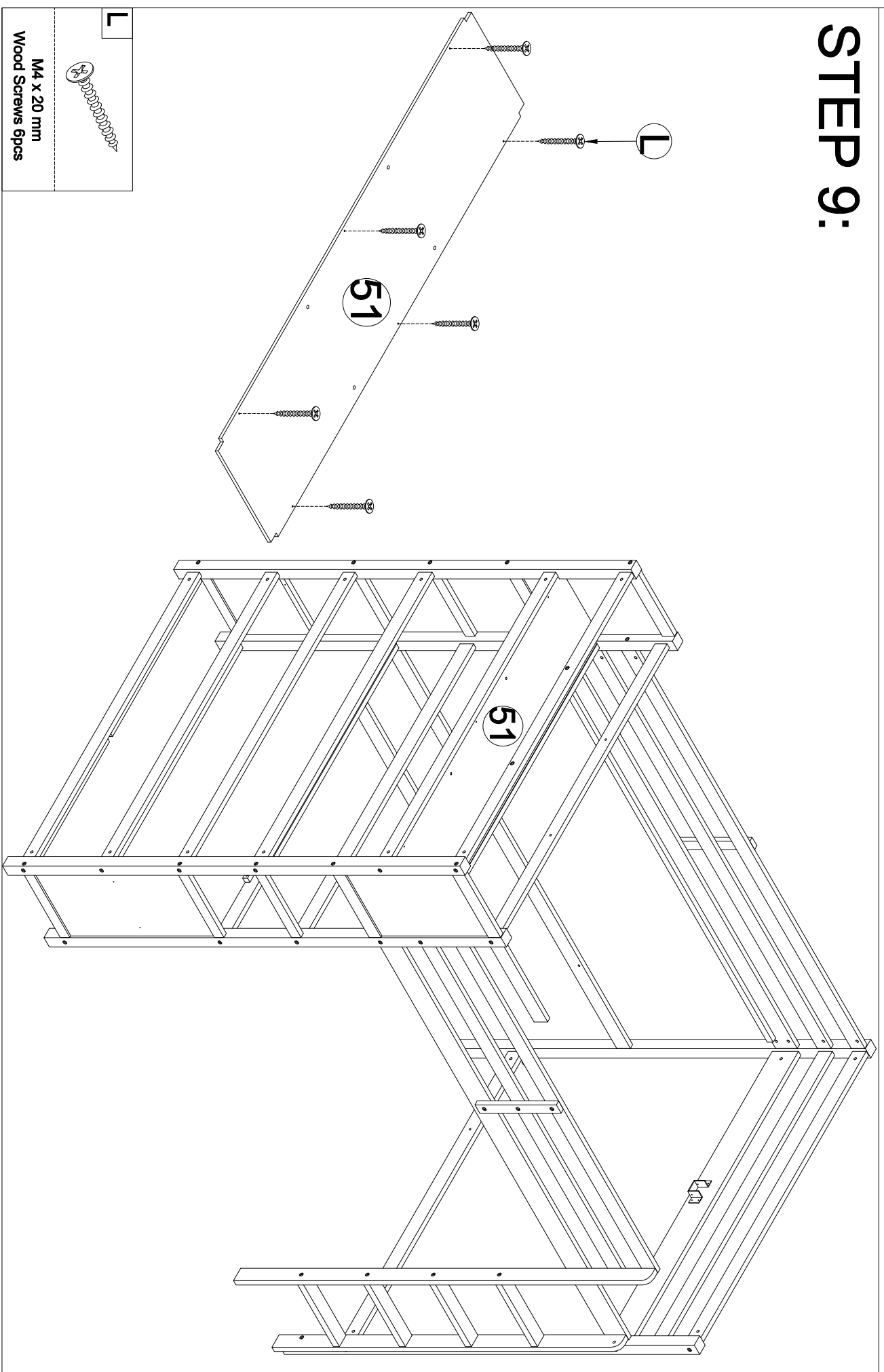

STEP 10:

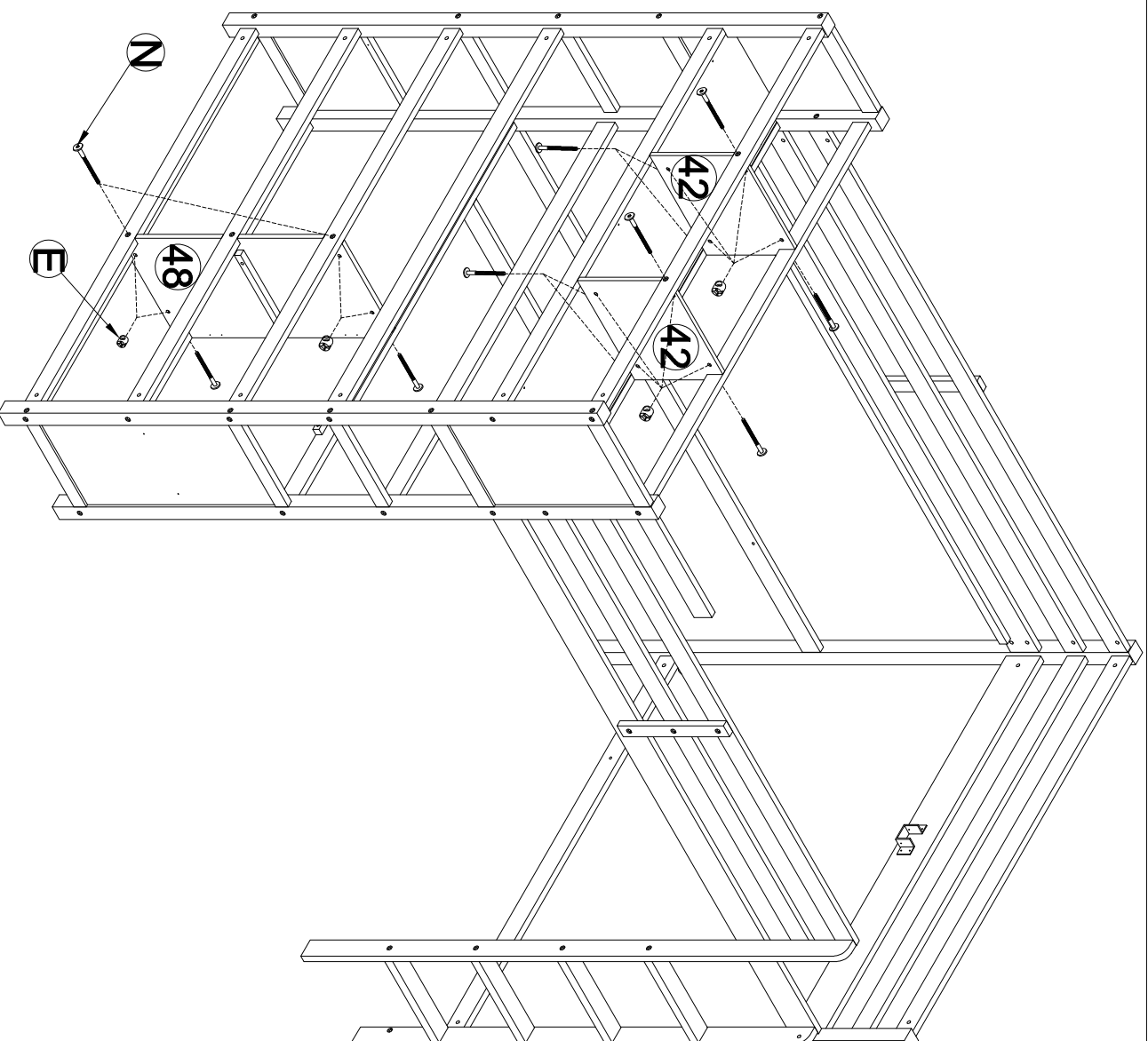

N

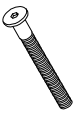

Ø1/4" x 60 mm
Hex-Head bolts 12pcs



E

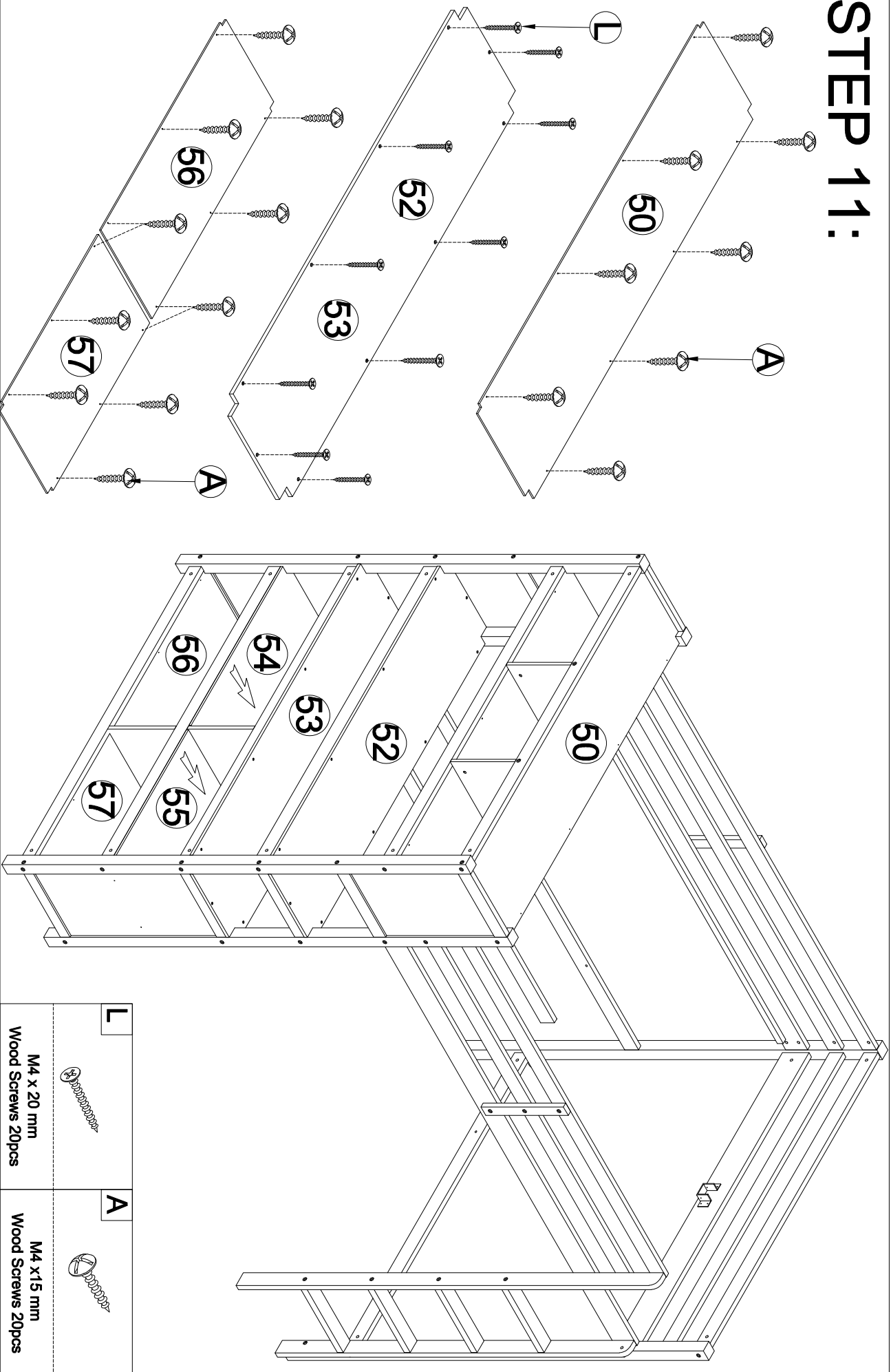

Ø1/4" x 13 mm
Horizontal-Hole bolts 12pcs

STEP 11:





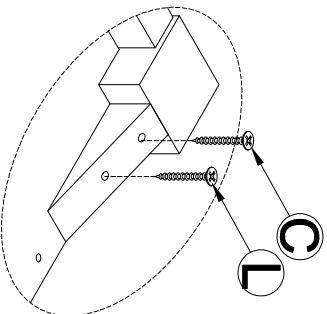

L	 M4 x 20 mm Wood Screws 20pcs	A	 M4 x15 mm Wood Screws 20pcs
---	--	---	---

STEP 12:

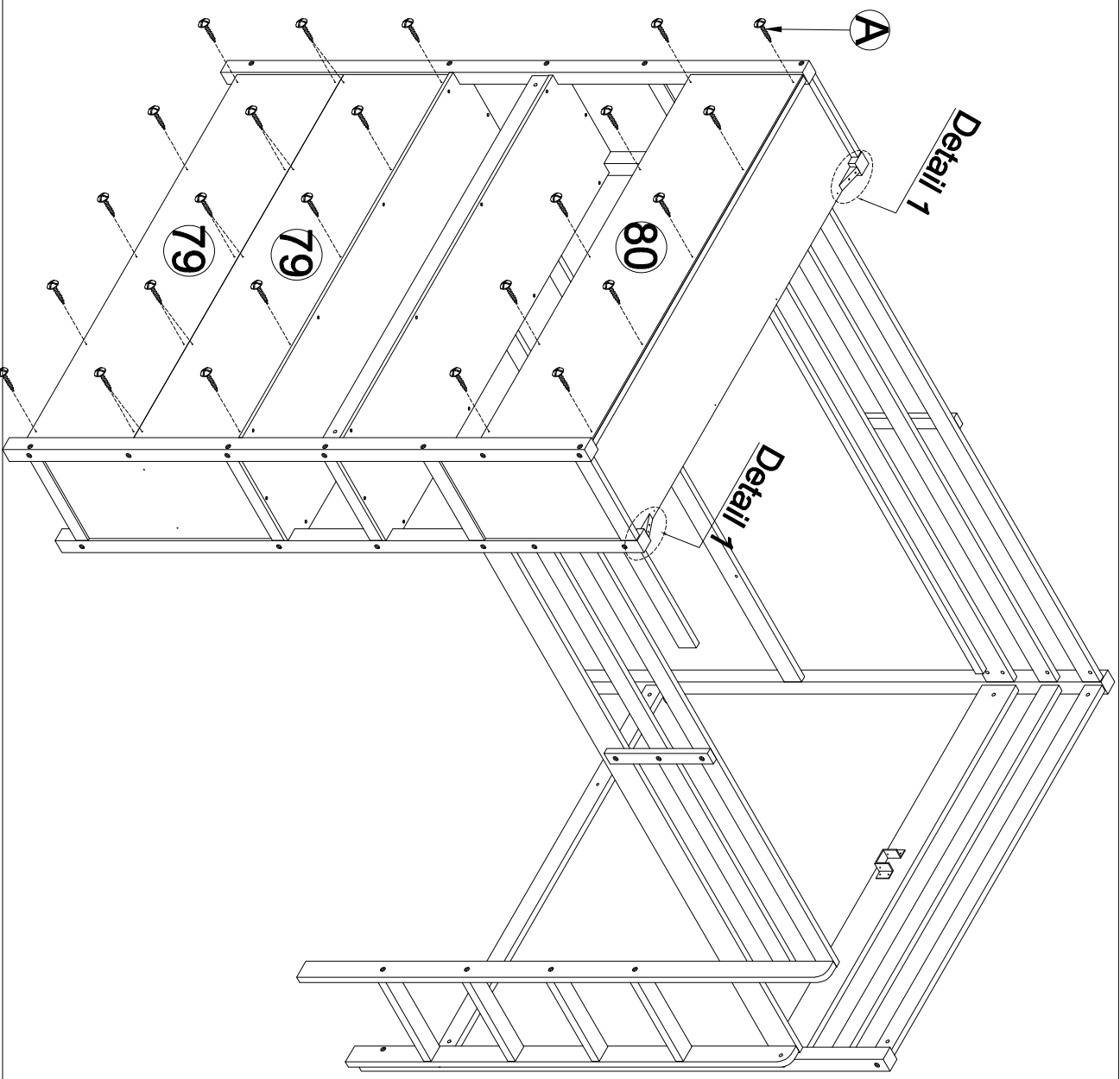



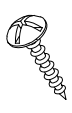

Detail 1 (x2)

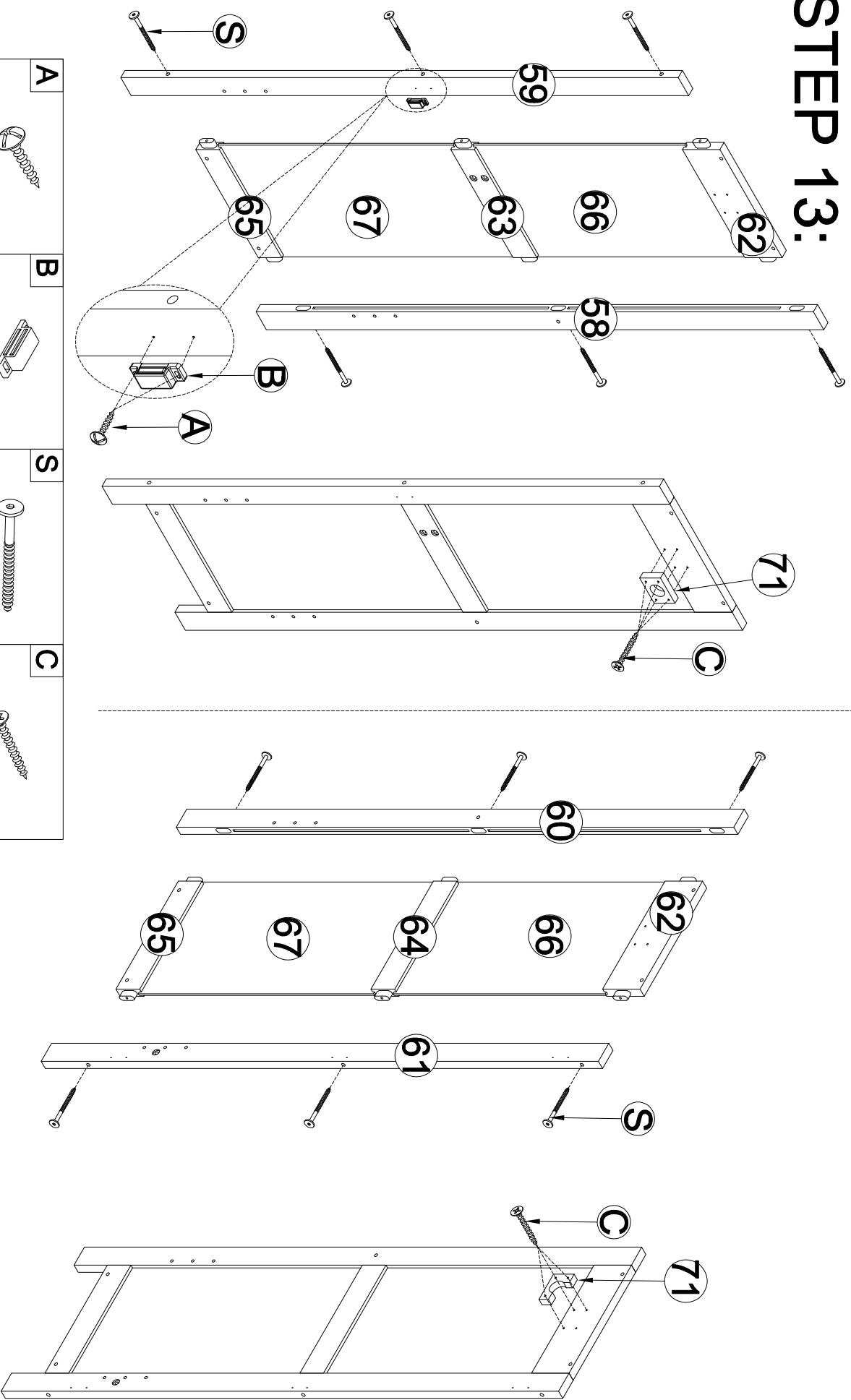

L	 M4 x 20 mm Wood Screws 2pcs
A	 M4 x 15 mm Wood Screws 30pcs
C	 M4 x 30 mm Wood Screws 2pcs





STEP 13:

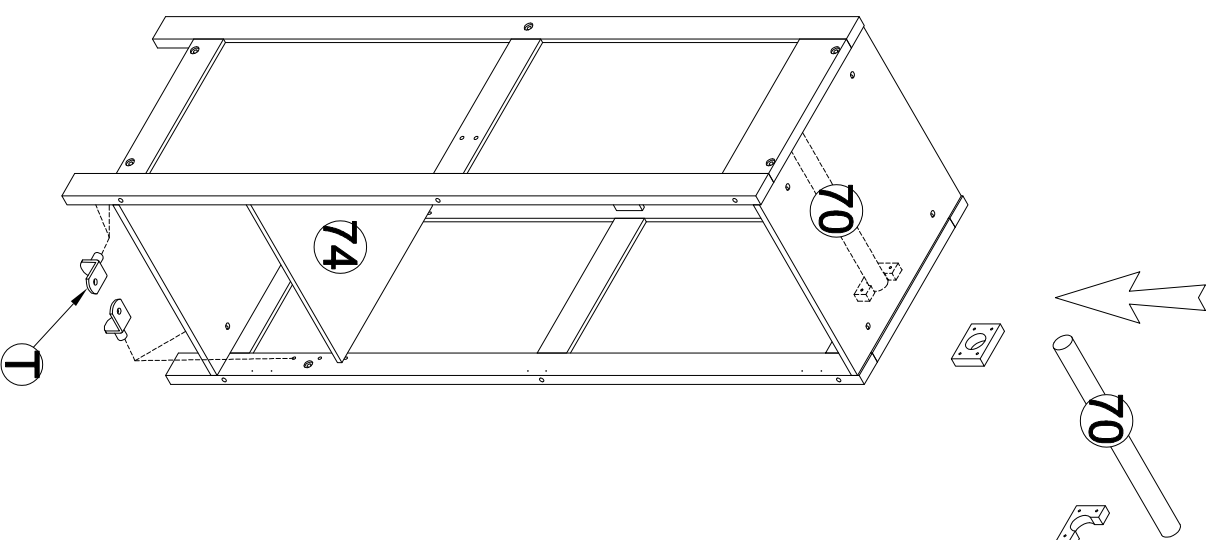
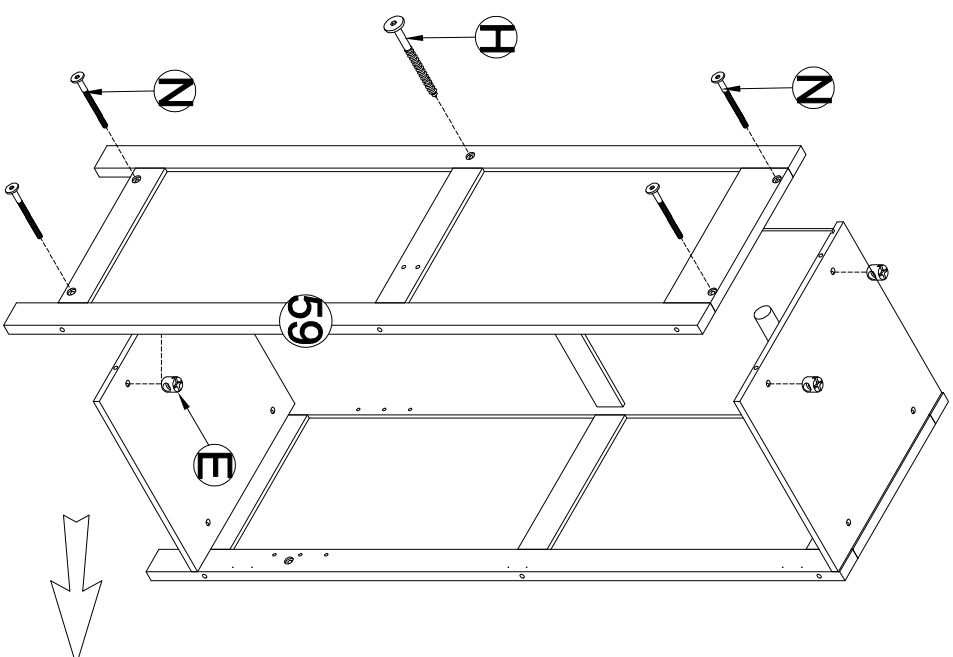
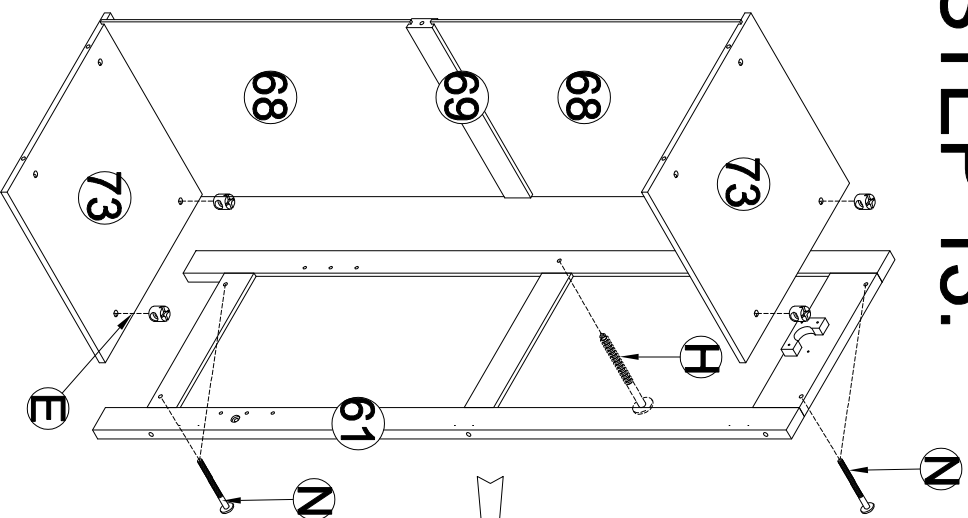

A	B	S	C
 <p>M4 x15 mm Wood Screws 2pcs</p>	 <p>Door Catches(45x17x13) 1pc</p>	 <p>Screws 1/4"x80 mm 12pcs</p>	 <p>M4 x 30 mm Wood Screws 7 pcs</p>







STEP 13:

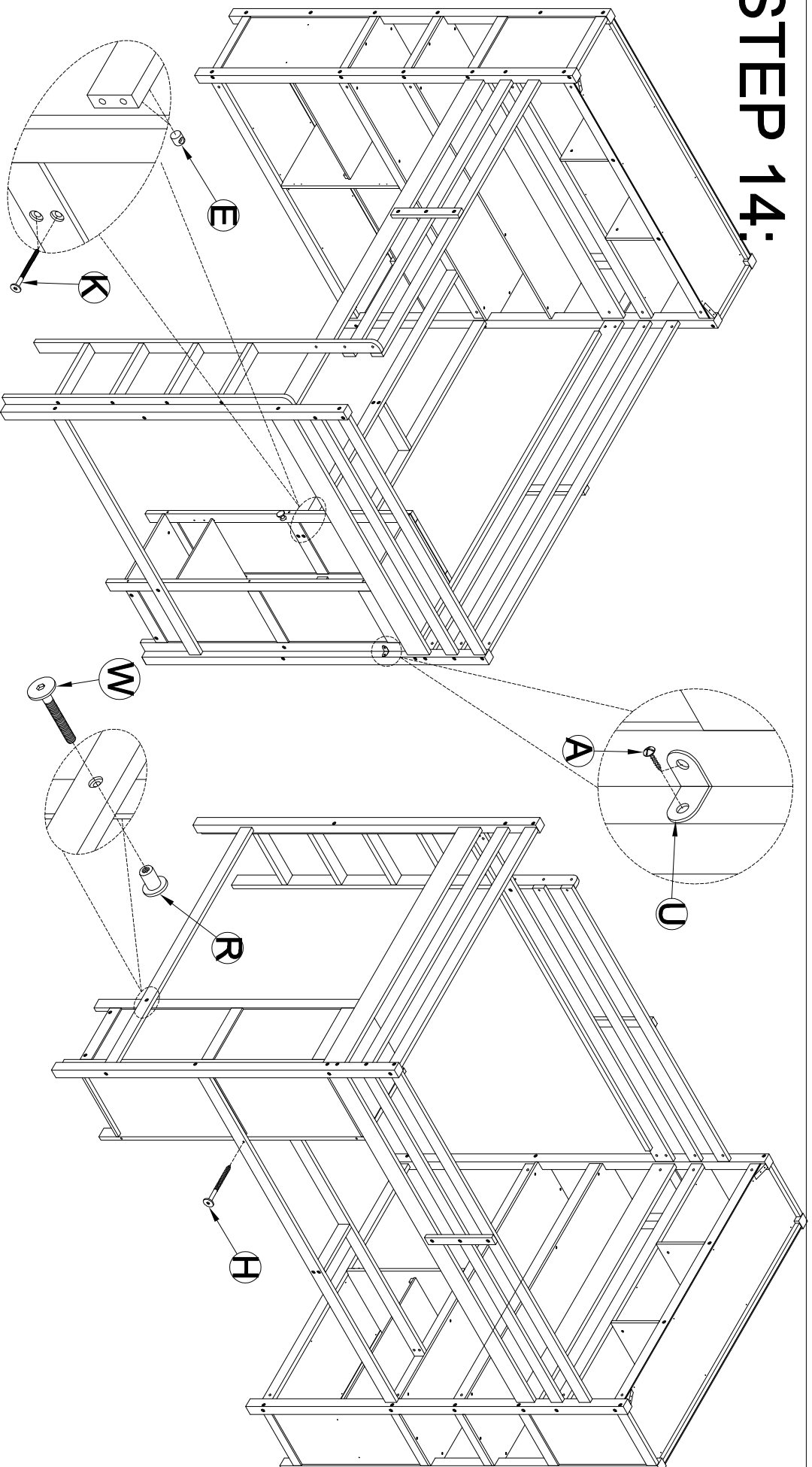

<p>N</p>  <p>Ø1/4" x 60 mm Hex-Head bolts 8pcs</p>	<p>E</p>  <p>Ø1/4" x 13 mm Horizontal-Hole bolts 8pcs</p>	<p>H</p>  <p>Screws 1/4"x50 mm 2pcs</p>	<p>T</p>  <p>Dowel Remove Shelves 4pcs</p>
--	---	---	---

STEP 14:



H  Screws 1/4" x 50 mm 1pc	K  Hex-Head bolts 2pcs Ø1/4" x 70 mm	E  Horizontal-Hole bolts 2pcs Ø1/4" x 13 mm	U  Steel Bracket 1pc	A  Wood Screws 2pcs M4 x15 mm	W  Hex-Head bolts 1pc Ø1/4" x 30 mm	R  Canopy head through -1pc Ø1/4" x 15 mm
---	---	--	---	--	--	--

STEP 15:

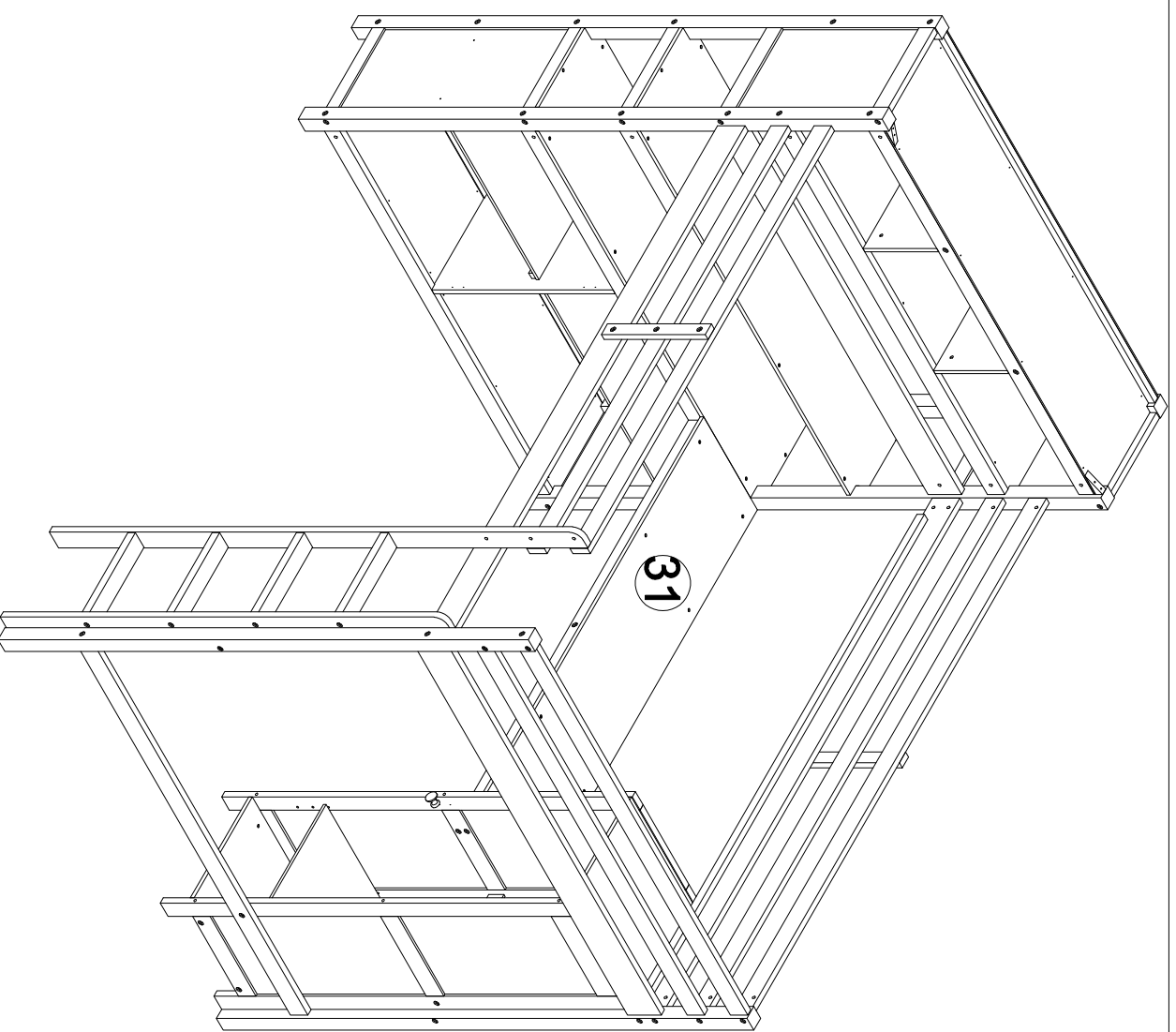
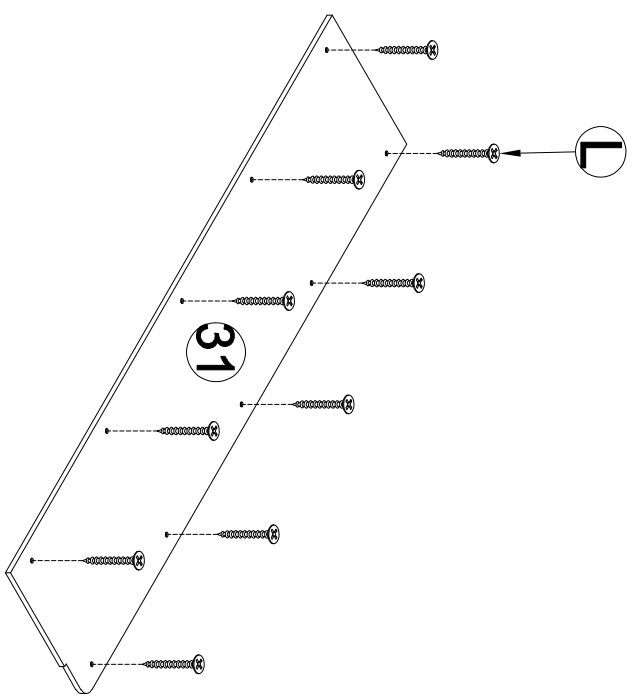





L

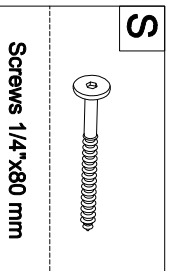
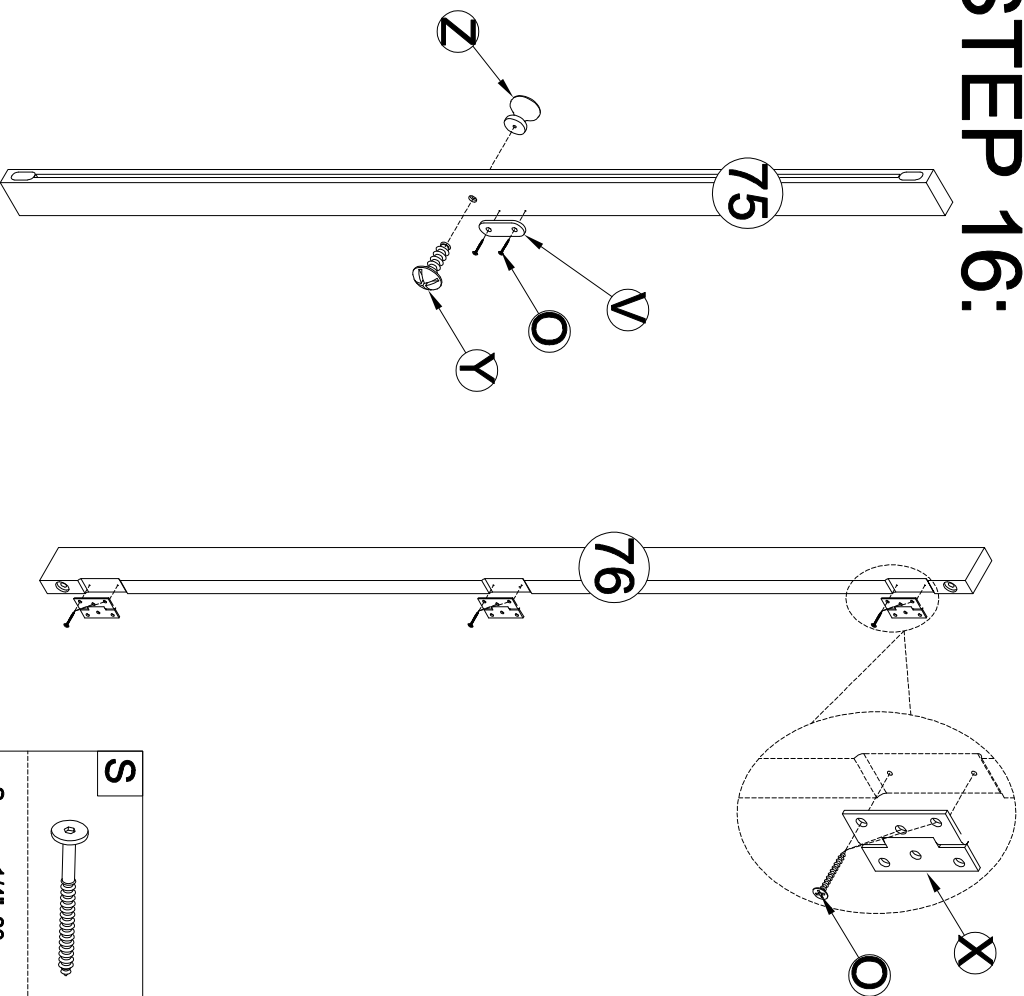

M4 x 20 mm
Wood Screws 10pcs

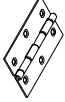
STEP 16:

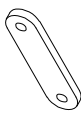

<p>X</p>  <p>Leaf hinge 3pcs</p>	<p>O</p>  <p>M3 x 12 mm Wood Screws 11pcs</p>	<p>Y</p>  <p>Ø1/6" x 25 mm Hex-Head bolts 1pc</p>	<p>Z</p>  <p>Handle Wood 1pc</p>	<p>V</p>  <p>Magnet Inhaler 1pc</p>
--	---	---	--	---

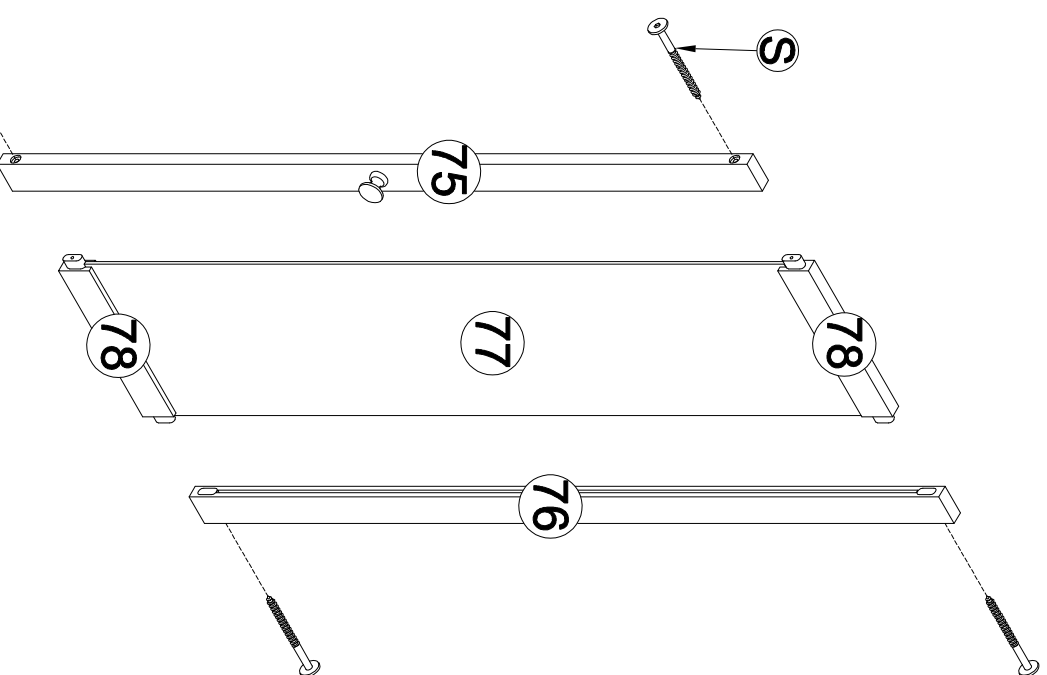

STEP 17.

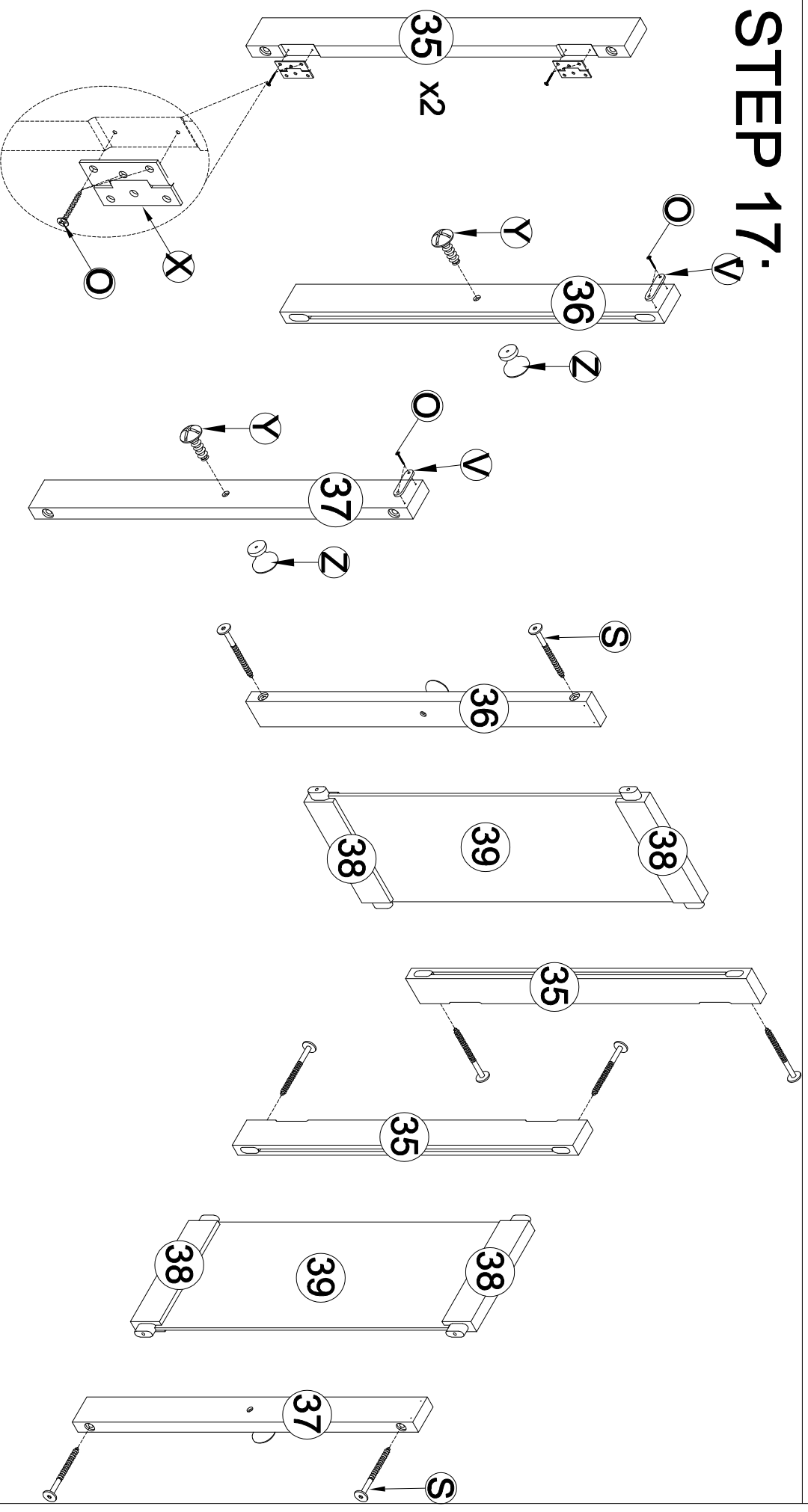

X	O	Y	Z	V	S
Leaf hinge 4pcs	M3 x 12 mm Wood Screws 16pcs	Ø1/6" x 25 mm Hex-Head bolts 2pcs	Handle Wood 2pcs	Magnet Inhaler 2pcs	Screws 1/4"x80 mm 8pcs

STEP 17:

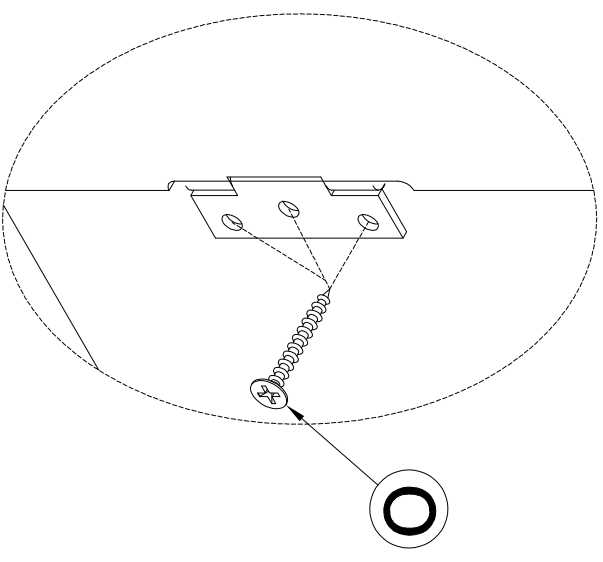
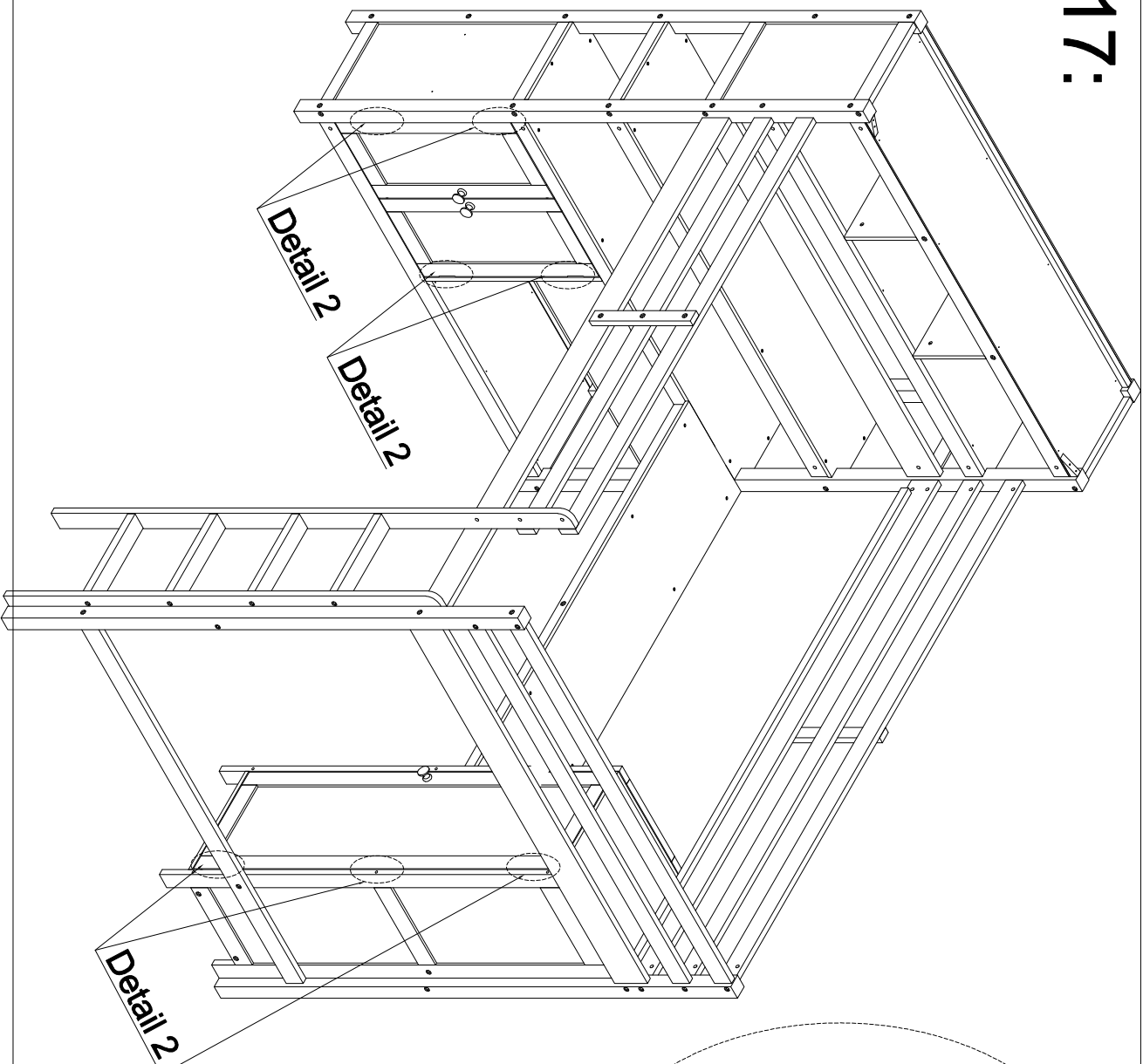

Detail 2(x7)

O



M3 x 12 mm
Wood Screws 21 pcs

STEP 18:

For Upper Bunk:

3-3/16"

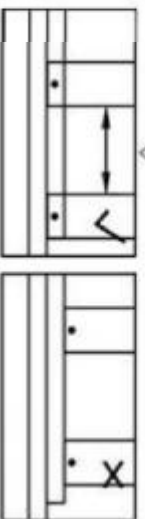

Do not lock the screws of the bed slats to the outermost edge the bed slats, you need to leave a certain space at the edges otherwise it you cause the board to break

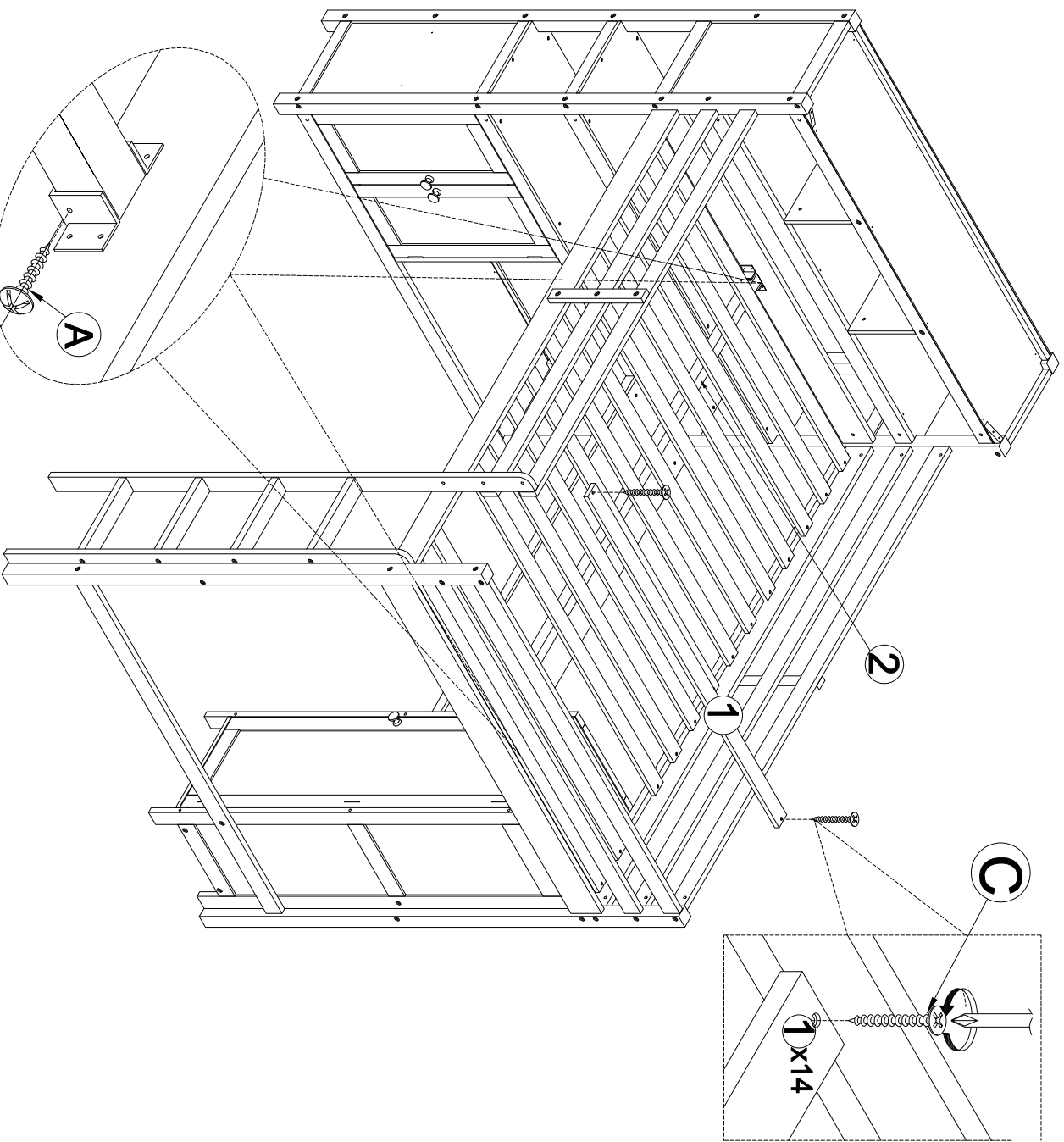

A



M4 x15 mm
Wood Screws 2pcs

C



M4 x 30 mm
Wood Screws 28pcs