

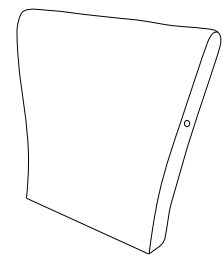
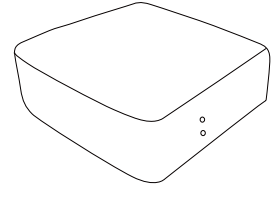
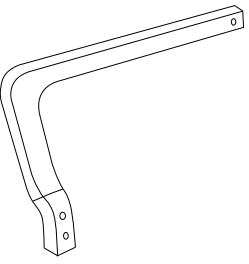
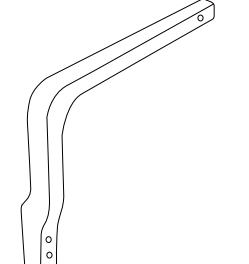
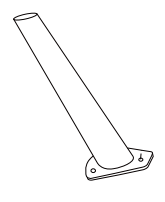
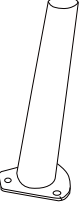
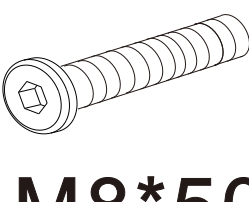

# ASSEMBLY INSTRUCTIONS

<b>A</b>		1PC
<b>B</b>		1PC
<b>C</b>		1PC
<b>D</b>		1PC
<b>E</b>		2PCS
<b>F</b>		2PCS
<b>G</b>	 M8*50	6PCS
<b>H</b>	 M6*16	12PCS
<b>I</b>	 M8*60	4PCS
<b>J</b>		4PCS
<b>K</b>		1PC
<b>L</b>		4PCS
<b>M</b>		6PCS

**Step1** (screw tightened 80%)

A X 1  
B X 1  
I X 4  
K X 1  
L X 4

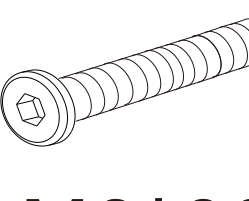
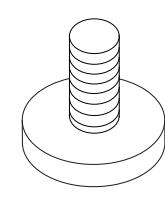
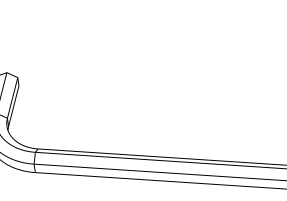
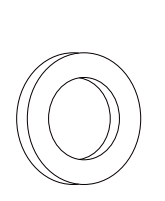
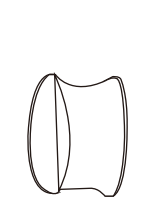
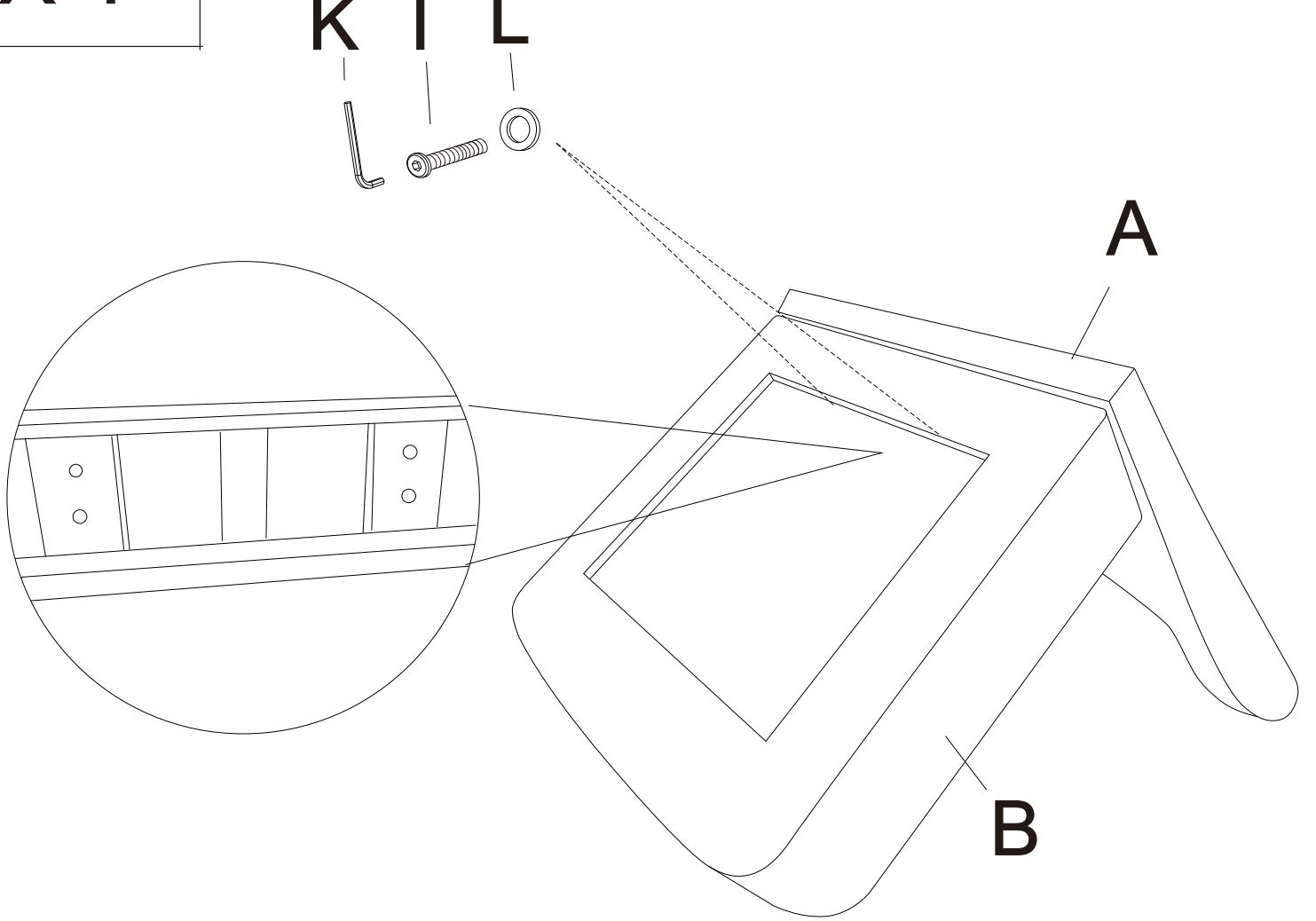

**Step2** (screw tightened 80%)

E X 2  
F X 2  
K X 1  
H X 12

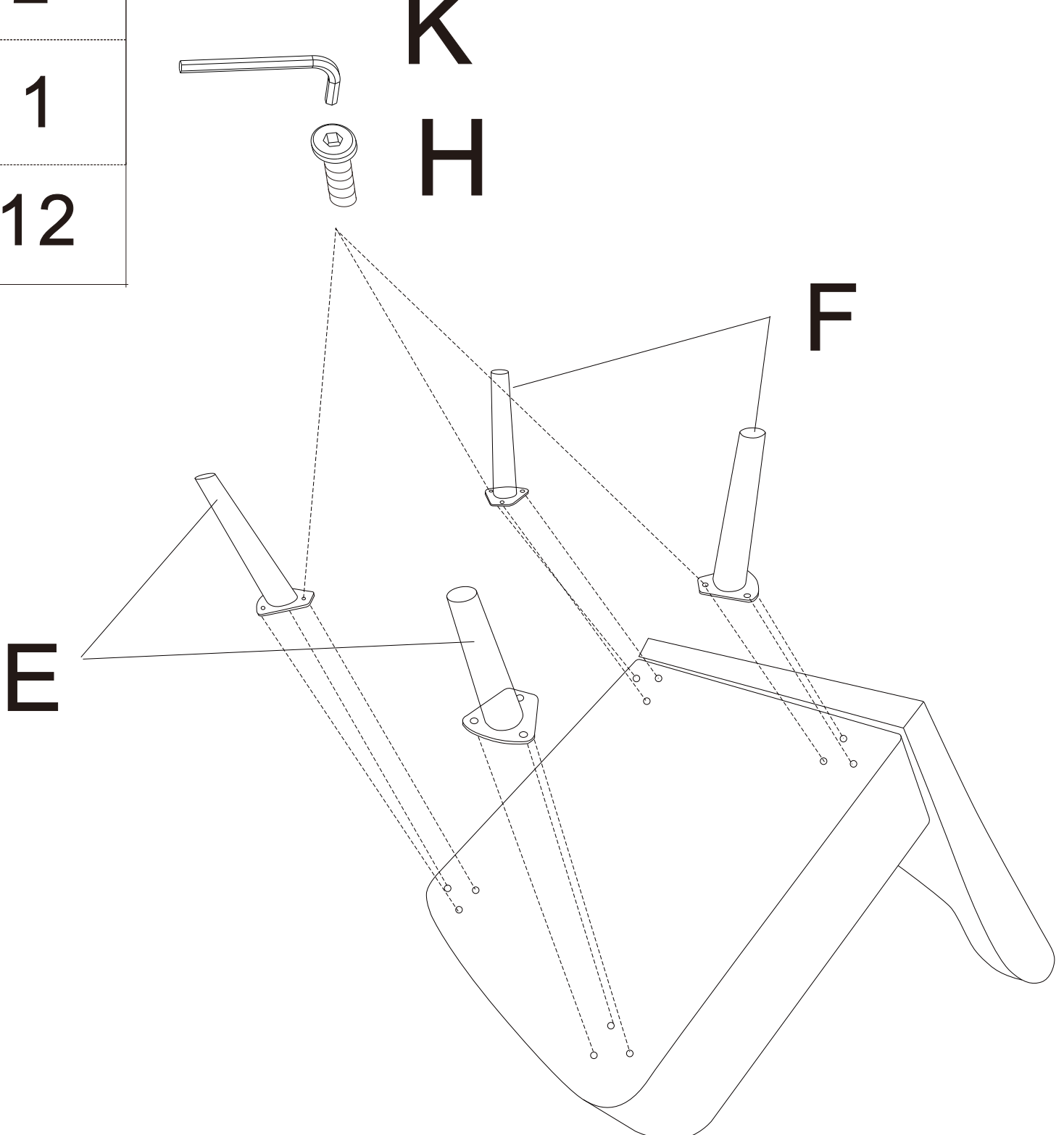

**Step3** (screw tightened 100%)

C X 1  
D X 1  
G X 6  
K X 1

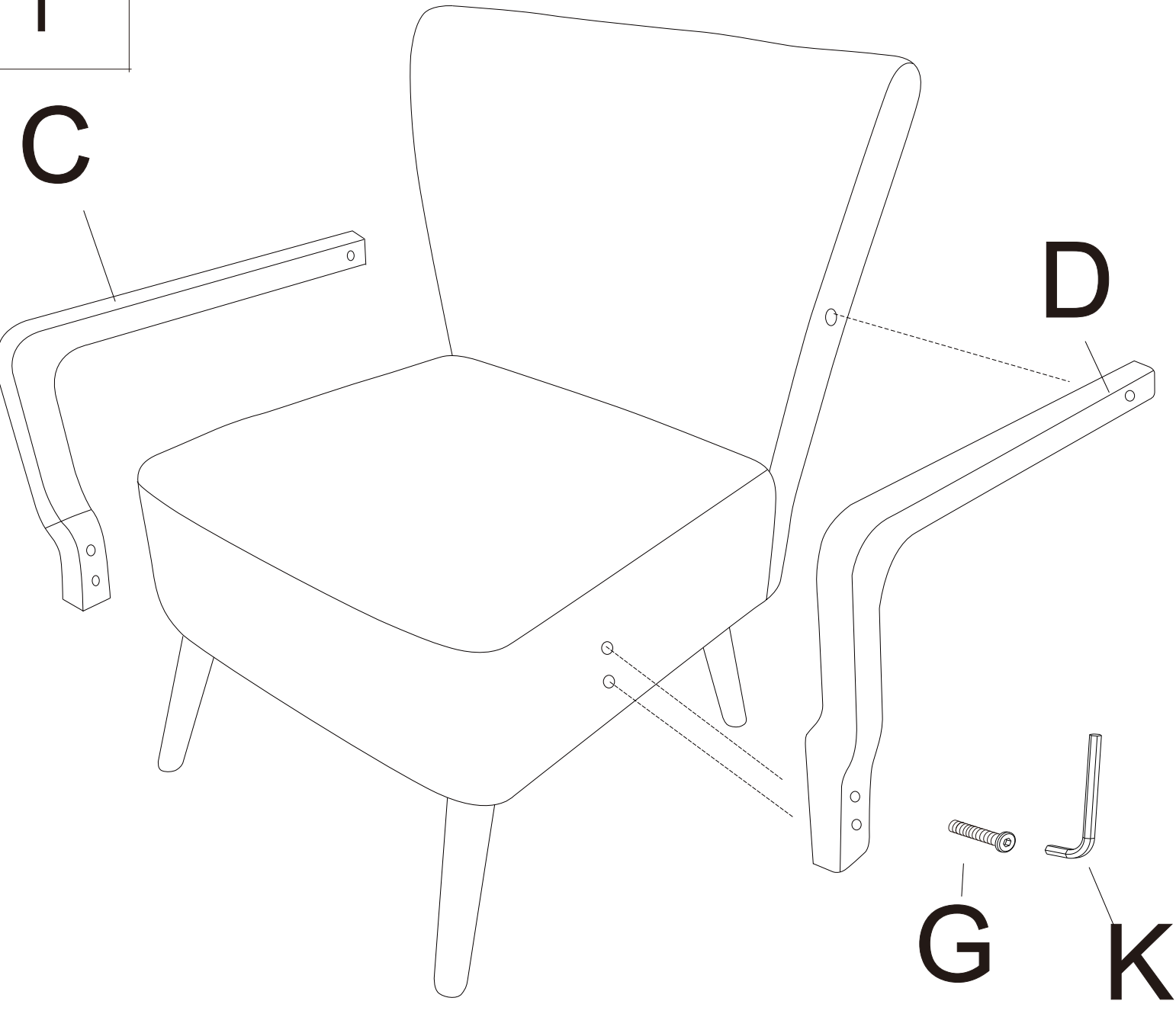

**Step4** (screw tightened 100%)

J X 4

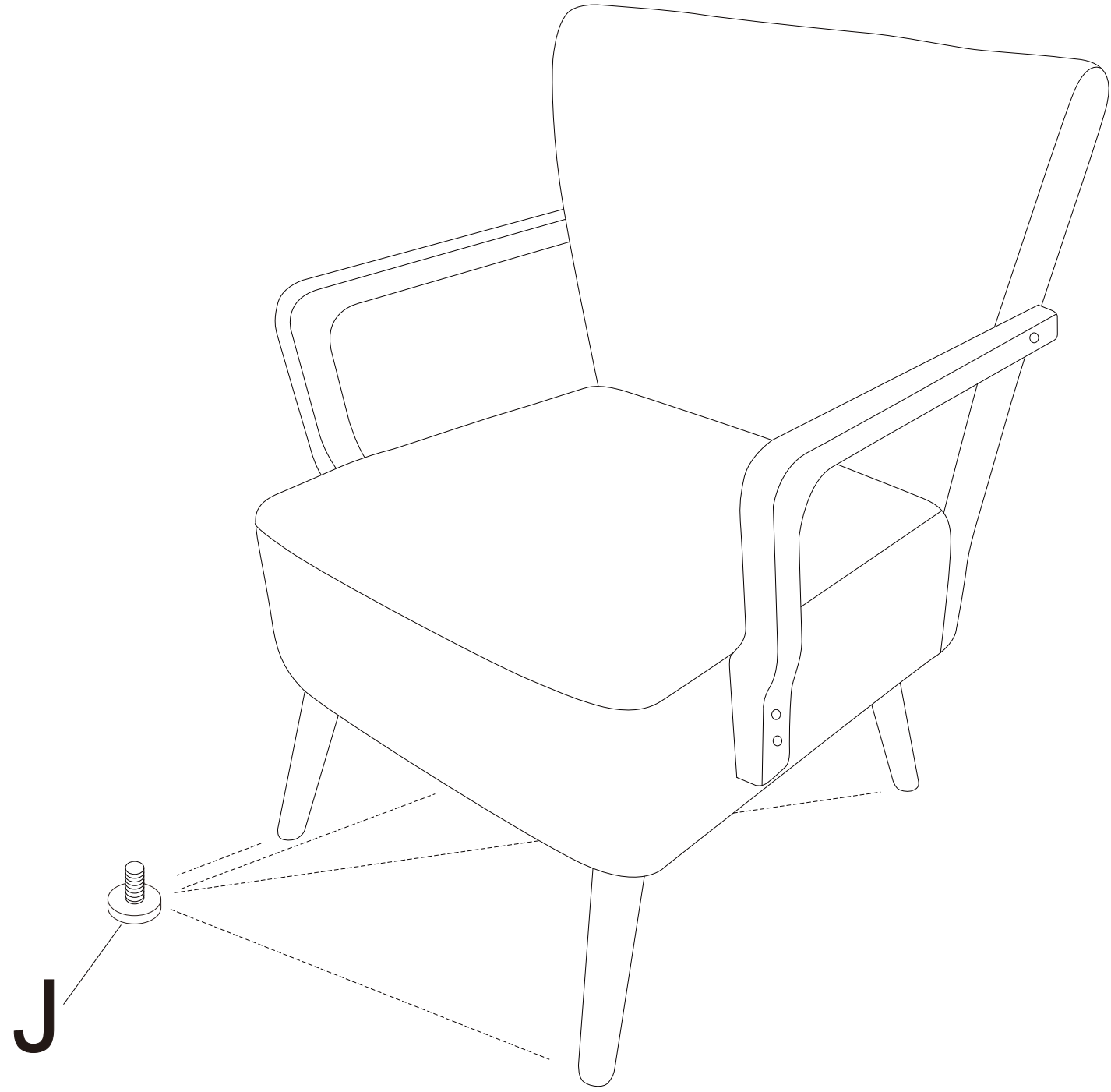

Make sure the chair is leveled on the ground.  
Adjust leveler if necessary.

**Step5**

M X 6

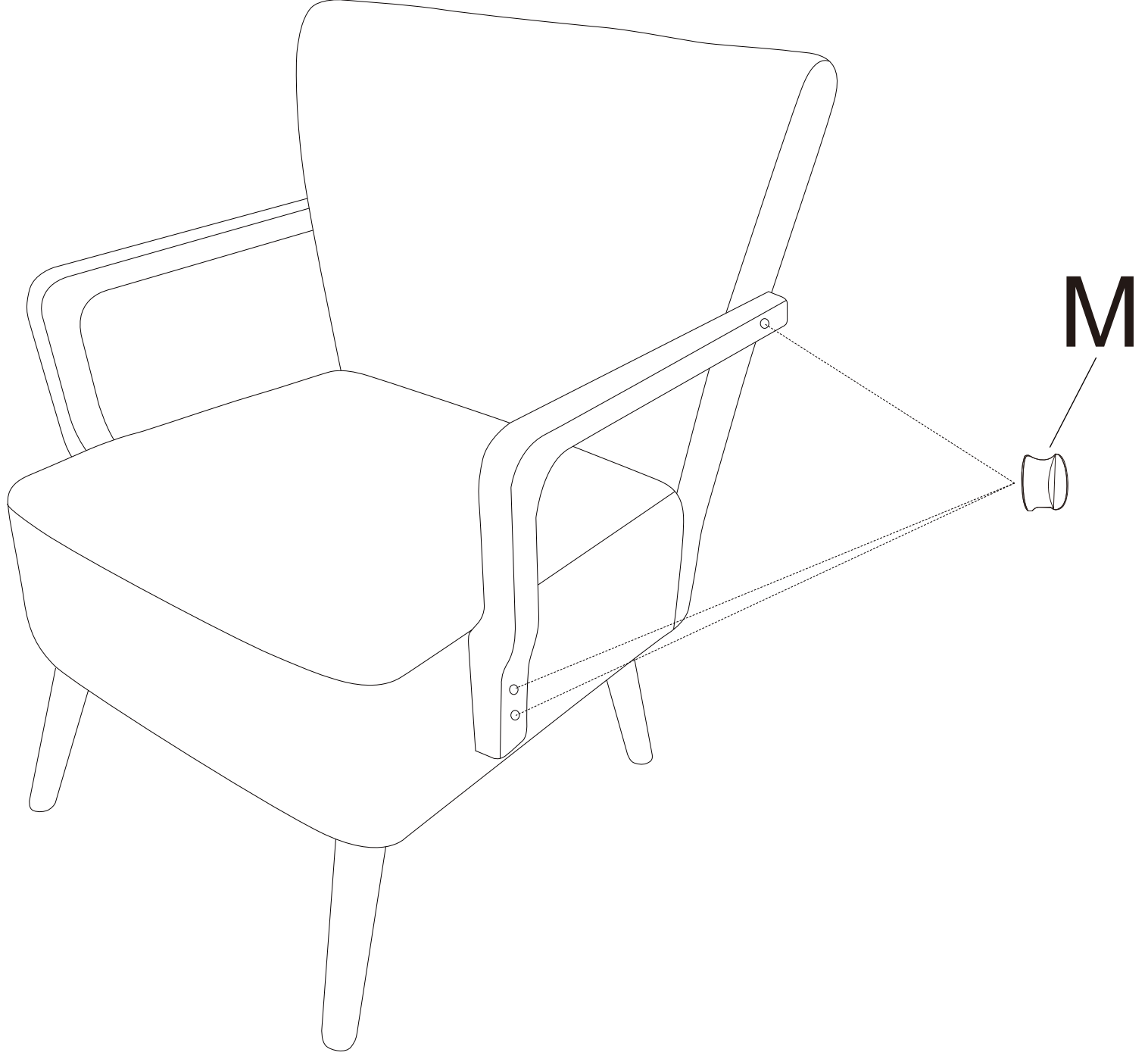

**WARNING: \*DO NOT STAND ON THE CHAIRS \*THESE CHAIRS ARE DESIGNED TO SEAT ONE PERSON ONLY PER CHAIR \*DO NOT USE THE CHAIR UNLESS ALL THE BOLTS AND SCREWS ARE FINALLY TIGHTENED**  
**\*AT LEAST EVERY FOUR MONTHS,PLEASE CHECK ALL BOLTS AND SCREWS TO MAKE SURE THEY ARE SECUREY TIGHTENED**  
**\*IF ANY PARTS ARE MISSING,BROKEN,DAMAGED OR WORN,STOP USING THIS PRODUCT IMMEDIATELY UNTIL REPAIRS ARE MADE**  
**\*FAILURE TO FOLLOW THESE WARNINGS COULD RESULT IN SERIOUS INJURY**