

SKU:W1445P173038

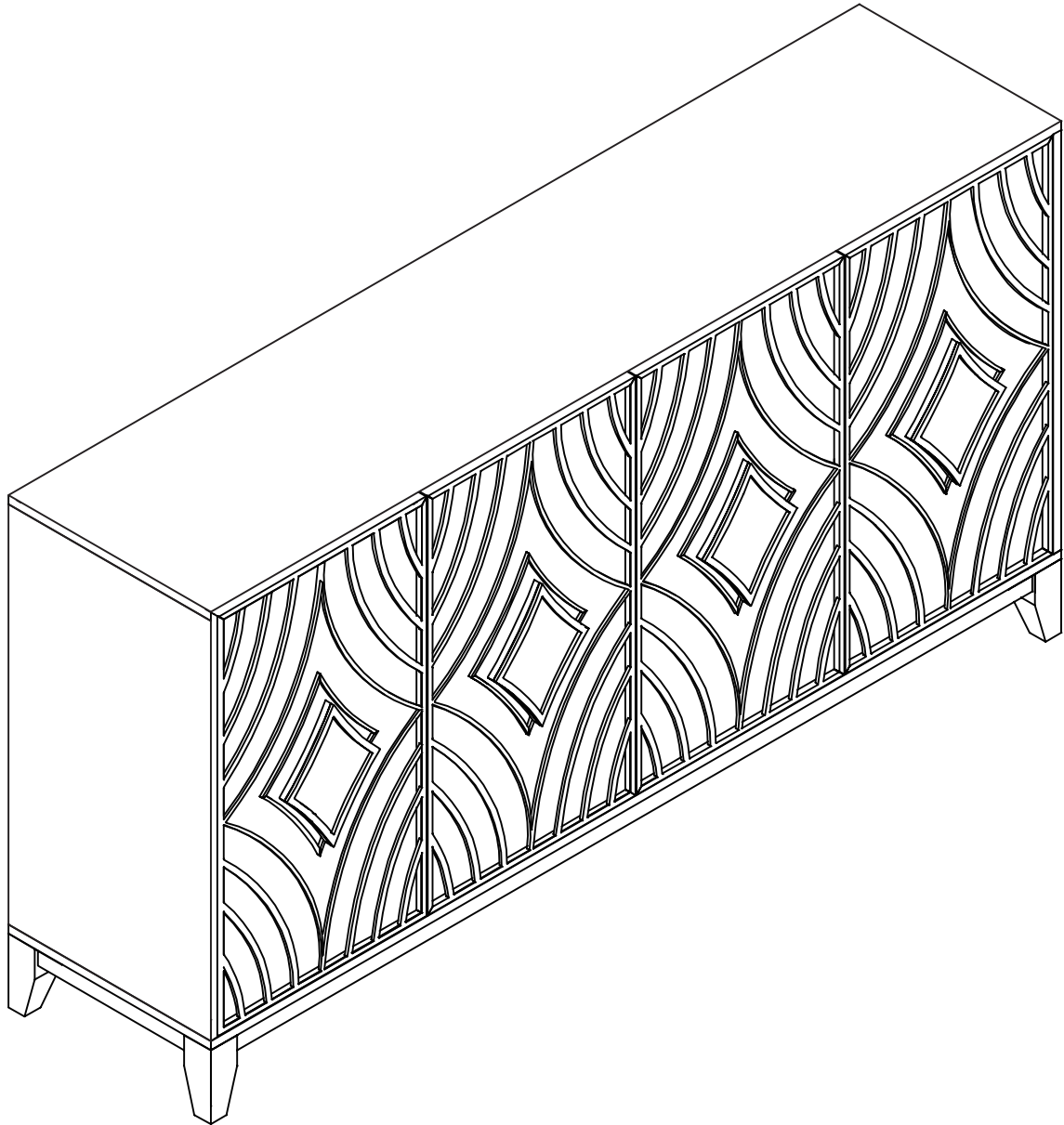

1. Thank you for choosing *our products*.

2. Return Policy







DO NOT RETURN TO THE STORE! Skip the process of returning your product and contact us directly for a replacement

If you find that parts of your order are missing or damaged, we will gladly ship any needed replacement parts free of charge.

If your product's quality does not meet your expectations or you have found any sort of defect, please contact our customer service department and let us know the details of your order and any issues encountered, we will try our best to provide you with a solution. Feel free to also directly contact our manufacturer concerning needed replacement parts and they will be happy to help provide you with a solution or answer any questions you may have.

Recommendations Before Beginning Assembly

-  • Read instructions, cover to cover
-  • Have 2-4 adults on hand for assembly depending on product size
-  • Do not assemble directly on flooring or carpet
-  • Assemble on a clean non-marring surface (example: packing foam)
-  • Save all packaging until finished









3. Assembly Notice:

- If you encounter any problems during assembly and find that you cannot continue, rest assured we will help you solve the situation as soon as possible. Simply keep all of the parts of the product stored in a safe place and contact us immediately so we may assist you further.
- Once you have opened your package, remove all inner hardware packages and take the parts out. One by one, Place the parts out neatly in front of you, then refer to the instructions to ensure no parts are missing. If any pieces are found missing, please carefully look in the box first, as the hardware packaging might have torn making the

hardware spill in the box.

- Some key parts of your product may be stored and hidden inside of other parts. Please open any zippered or hook & loop storage compartments to remove all parts. (example: cushions and legs being stored in the underside of a sofa)
- **IMPORTANT:** When setting up your product, **DO NOT INSTALL THE SCREWS ALL THE WAY IN THE BEGINNING.** Place each screw into their proper hole and use your hand to twist the screw halfway. Twist all the screws in halfway to ensure the holes will match up properly and the product is level on the ground. When everything seems fitted, then tighten the screws.
- When you have completed assembly, we suggest you have more than one person to assist you with lifting and placing the product.

Care & Maintenance

- ⊘  ● Do not put hot items directly on furniture surface
- ⊘  ● Do not clean furniture with harsh cleansers or polish
- ⊘  ● Do not place furniture under direct sunlight
- ⊘  ● Do not place furniture near heating or cooling vents
- ⊘  ● Do not write on furniture without a padded barrier to protect the surface
- ⊘  ● Do not place furniture outside. For indoor use only
- ⊘  ● Not for commercial use. For residential use only
- ⊘  ● Stains may be removed with mild soap solution and damp cloth
- ⊘  ● Children should not climb or jump on the furniture
- ✓  ● Dust and pick-up spills using a clean, non-colored, lint-free cloth

Caution





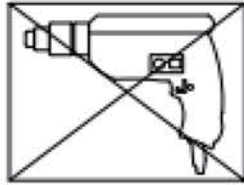



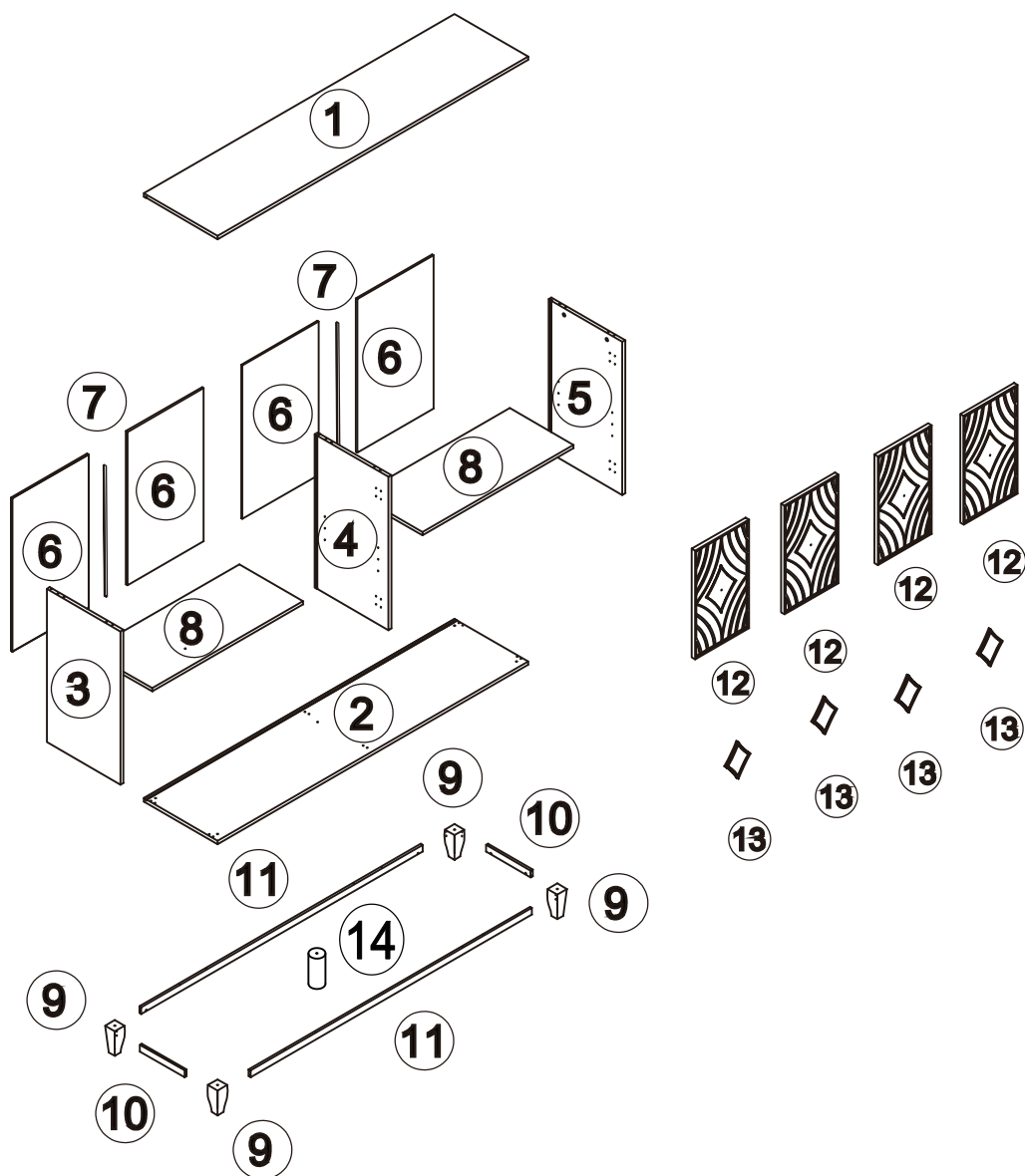
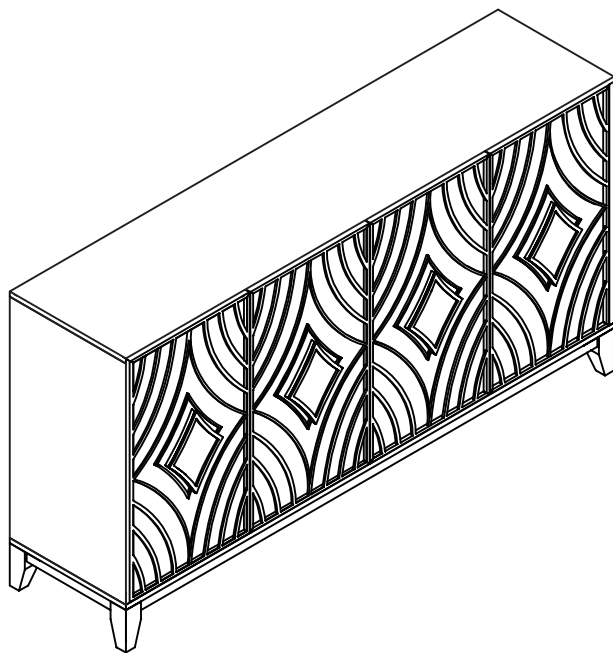

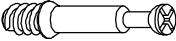

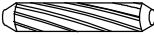
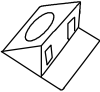

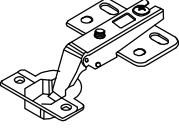
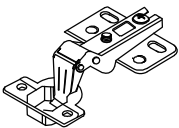
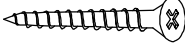
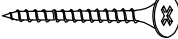
● This product contains small components. Please ensure that they are kept away from small children.

● Do not use power tools to assemble your furniture. Power tools may strip or damage the parts.



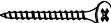
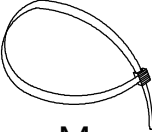
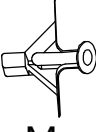

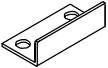

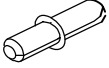

W1445P173038

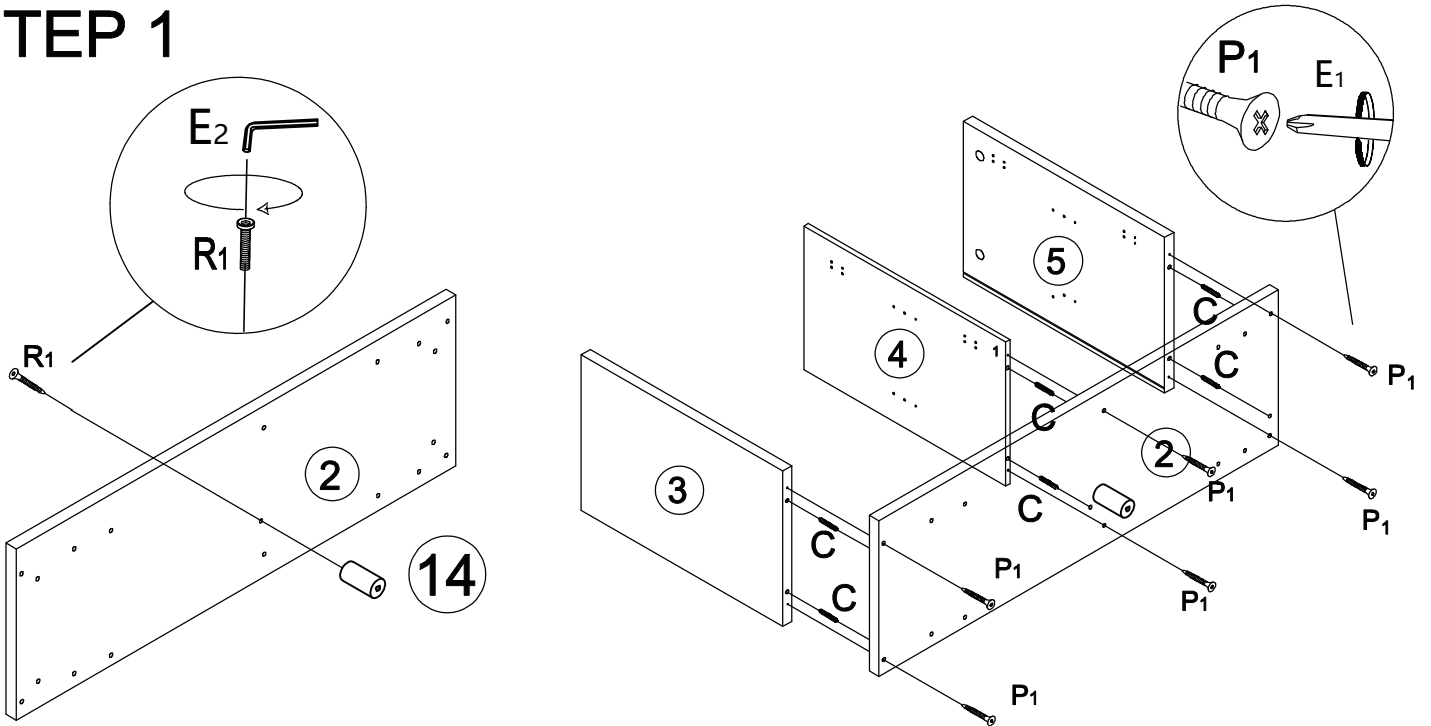

 Ø6x35mm	 Ø15x12mm	 Ø6x30mm		
AX14	BX14	CX 24	DX8	E1 X1
		 Ø5x60mm	 Ø4x50mm	 Ø 4 x16mm
FX4	GX4	P1 X6	P2X4	P3 X48
 Ø3x14mm		 M1	 M2	 M3
P4X12	QX4	 M4		
		 M5		
		MX1		
 Ø8x45mm		 Ø6x25mm		
R1 X5	LX2	R2 X4	E2 X1	J X8

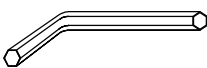
STEP 1



 Ø8x45mm		 Ø6x30mm	 Ø5x60mm	
R1 X1	E2 X1	C X6	P1 X6	E1 X1

STEP 2

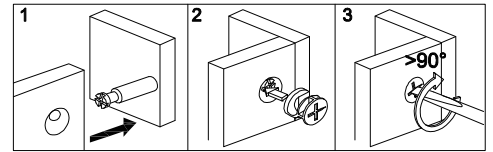
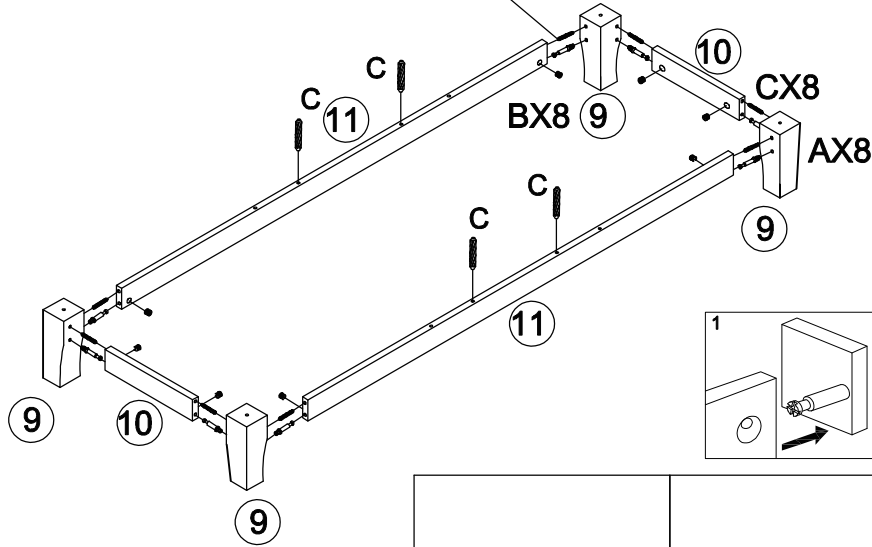
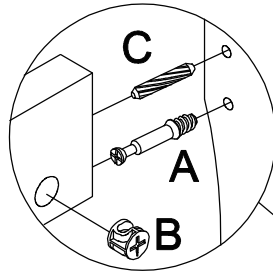
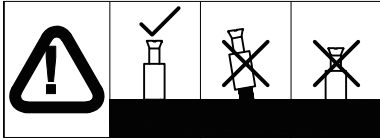

Ø6x35mm	Ø15x12mm	Ø6x30mm
AX8	B X8	C X12

STEP 3

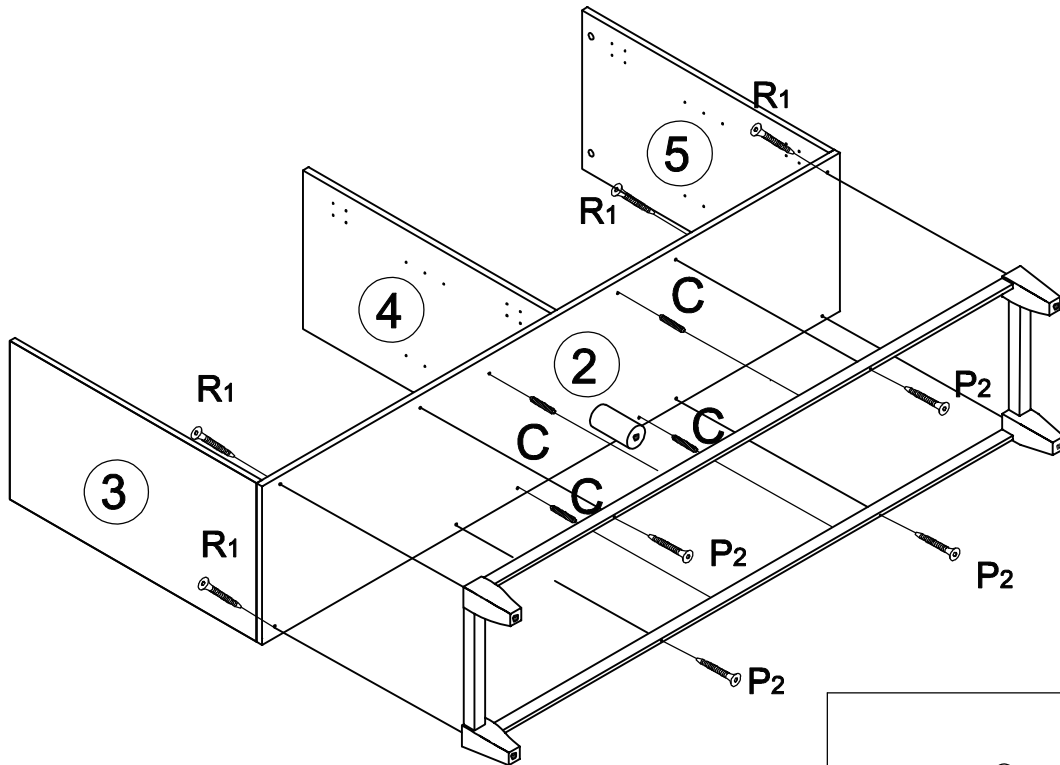

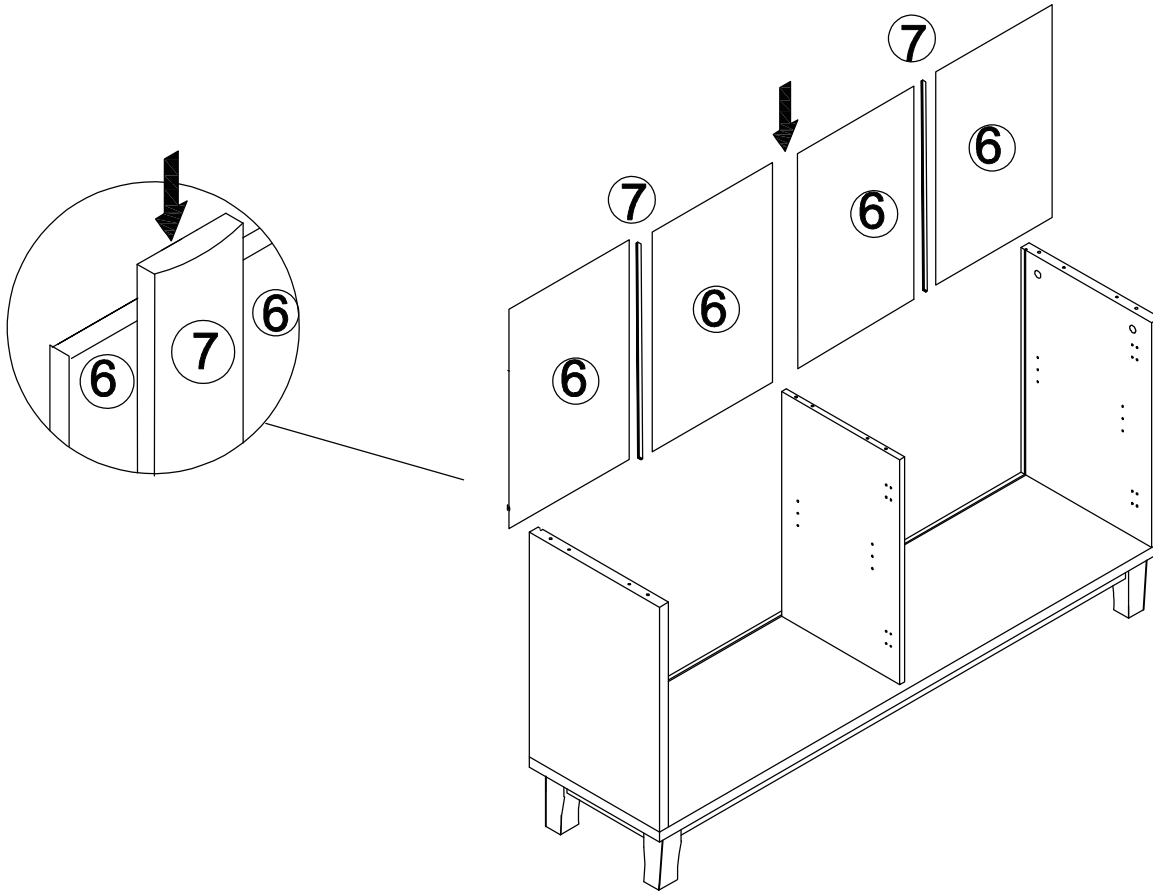

Ø8x45mm	Ø4x50mm
R1 X4	P2X4

STEP 4

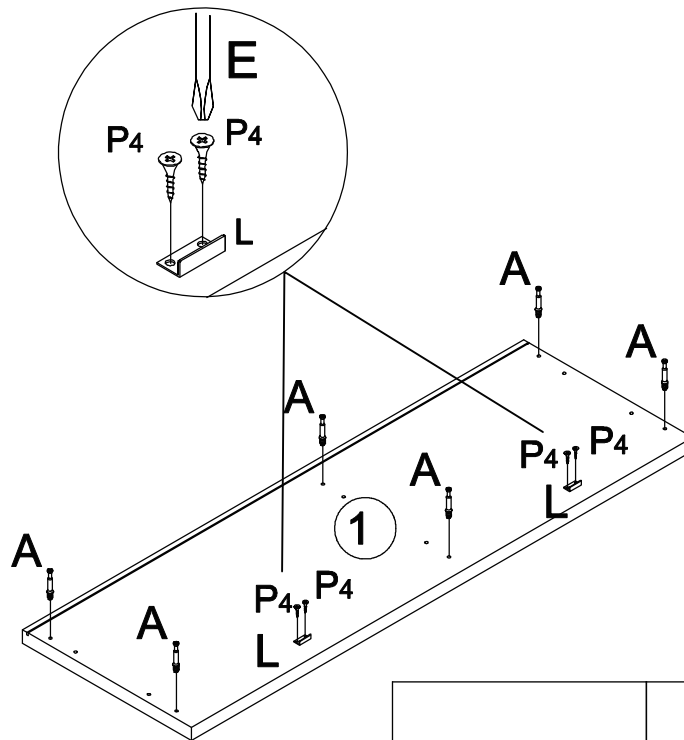

STEP 5

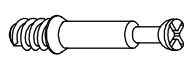

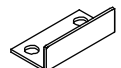
		
Ø6x35mm AX6	Ø3x14mm P4X4	LX2

STEP 6

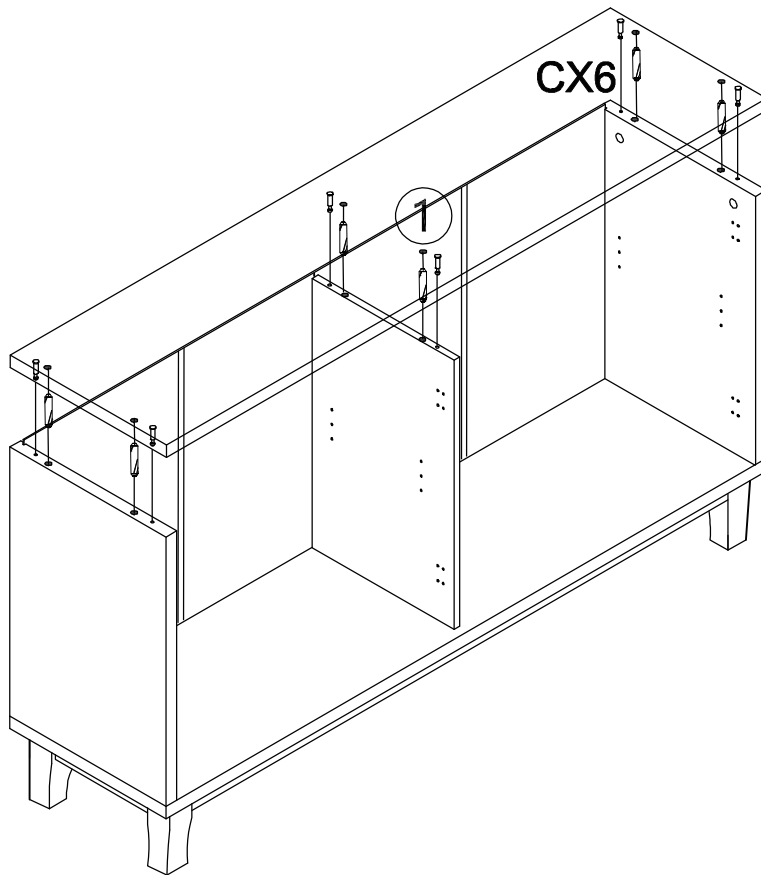

Ø6x30mm

CX6

STEP 7

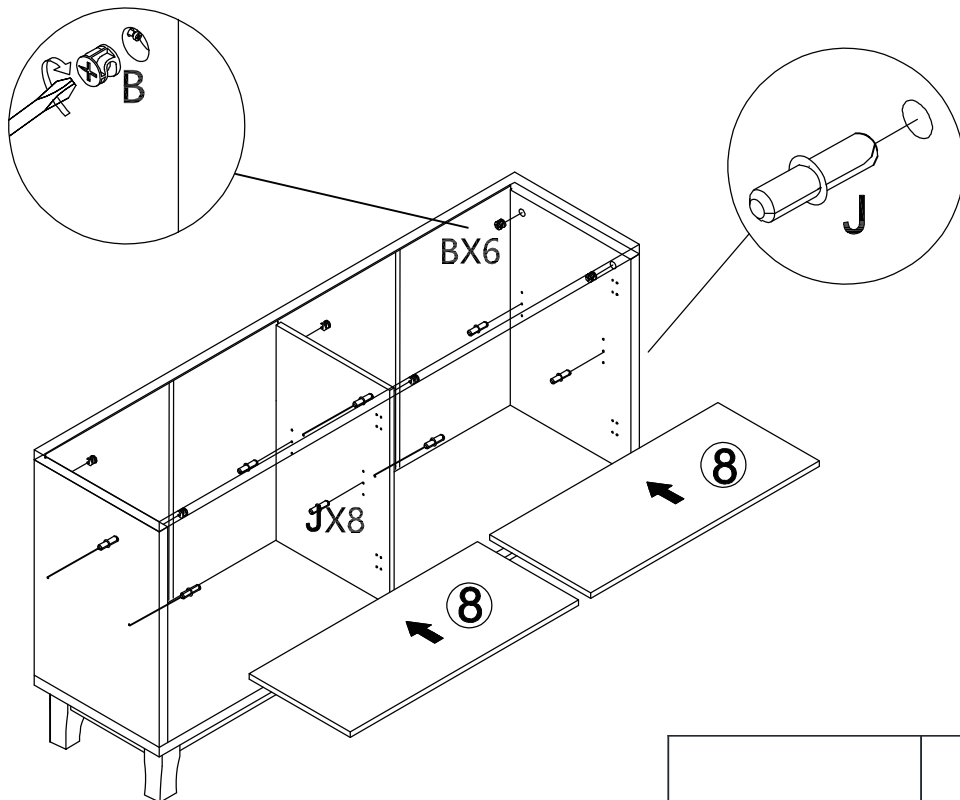

Ø15x12mm

BX6

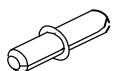

J X8

STEP 8

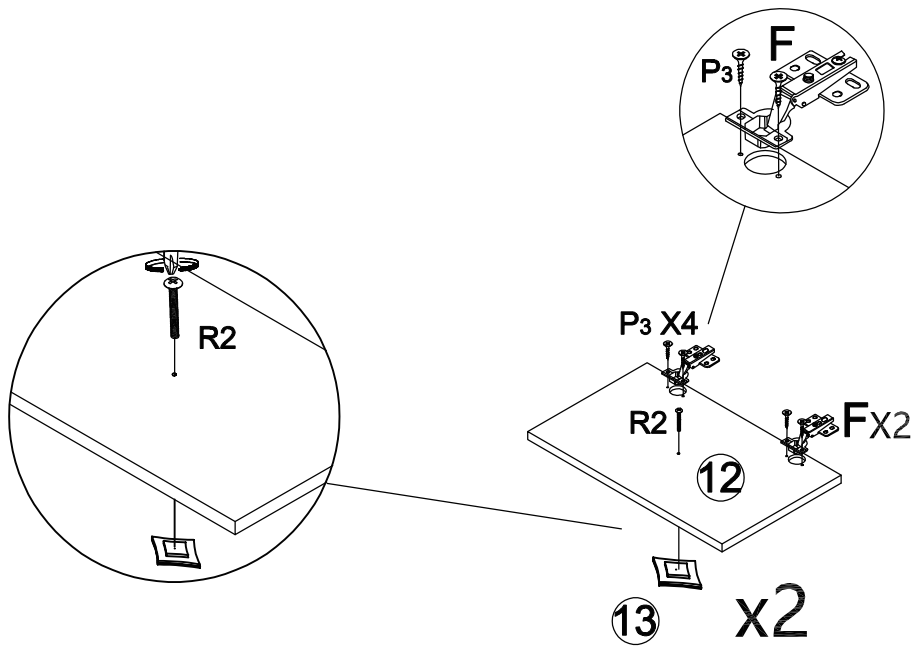

F X4	Ø 4 x16mm	Ø6x25mm
	P ₃ X8	R ₂ X2

STEP 9

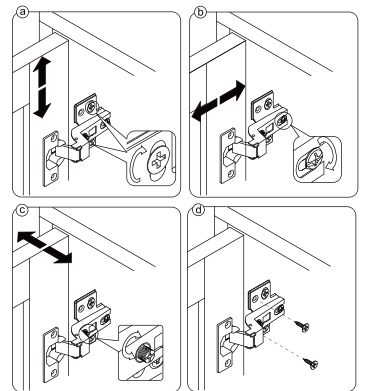
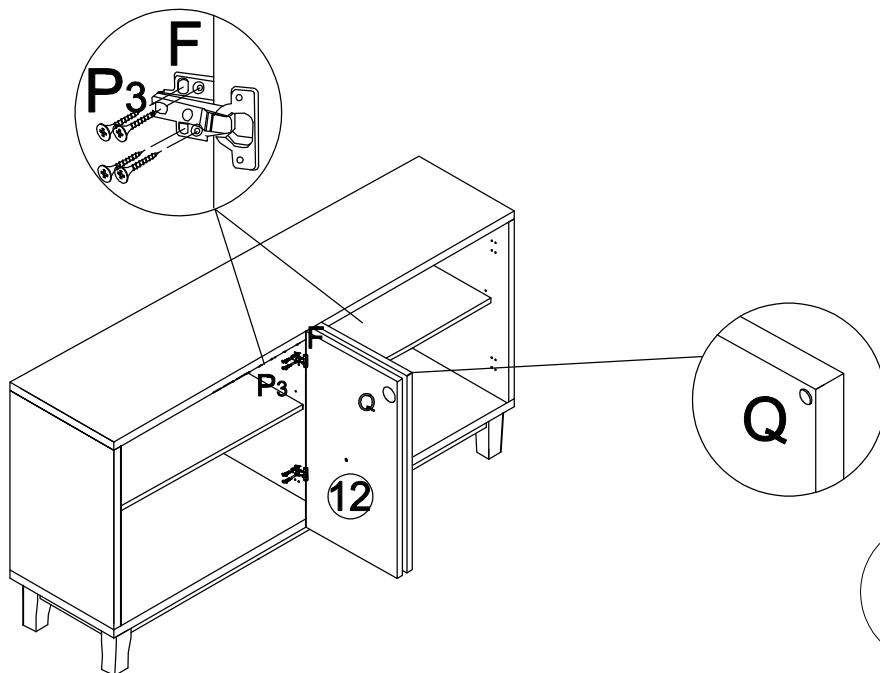

NOTE: If the doors are uneven or there is a gap in the middle, loosen or tighten the screw on the door hinge until they are sitting flush.

QX2	Ø 4 x16mm
	P ₃ X16

Assembly Steps(EN) / Montageschritte(DE)

HOW TO ADJUST THE HINGES TO ALIGN THE DOORS IF NEEDED.

STEP 1

Open the door.

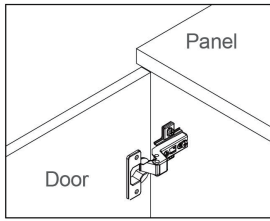

STEP 2

Adjust the door panels upward or downward

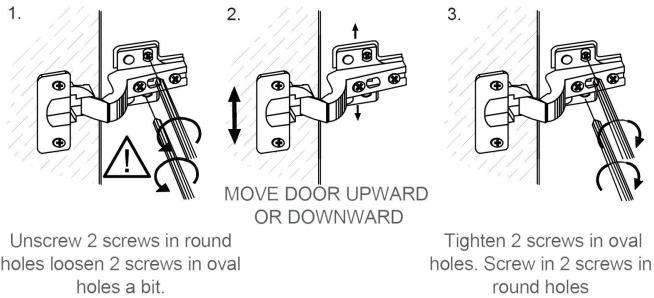

STEP 3

Adjust the flush between door panel and side panel

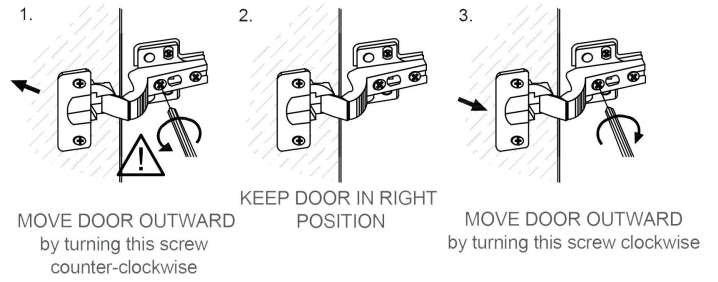

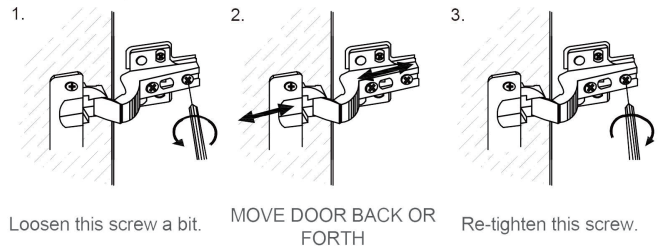

STEP 4

Adjust the Gap between door panel and side panel



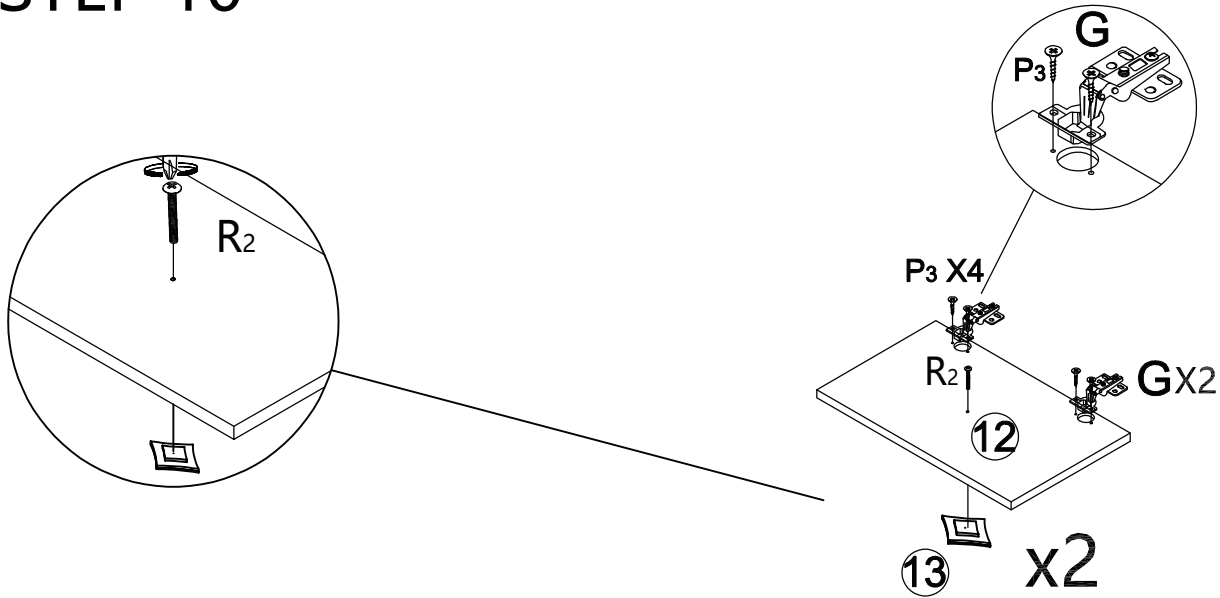

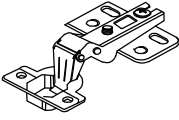
STEP 10



		
GX4	Ø 4 x 16mm	Ø 6 x 25mm
	P3 X 8	R2 X 2

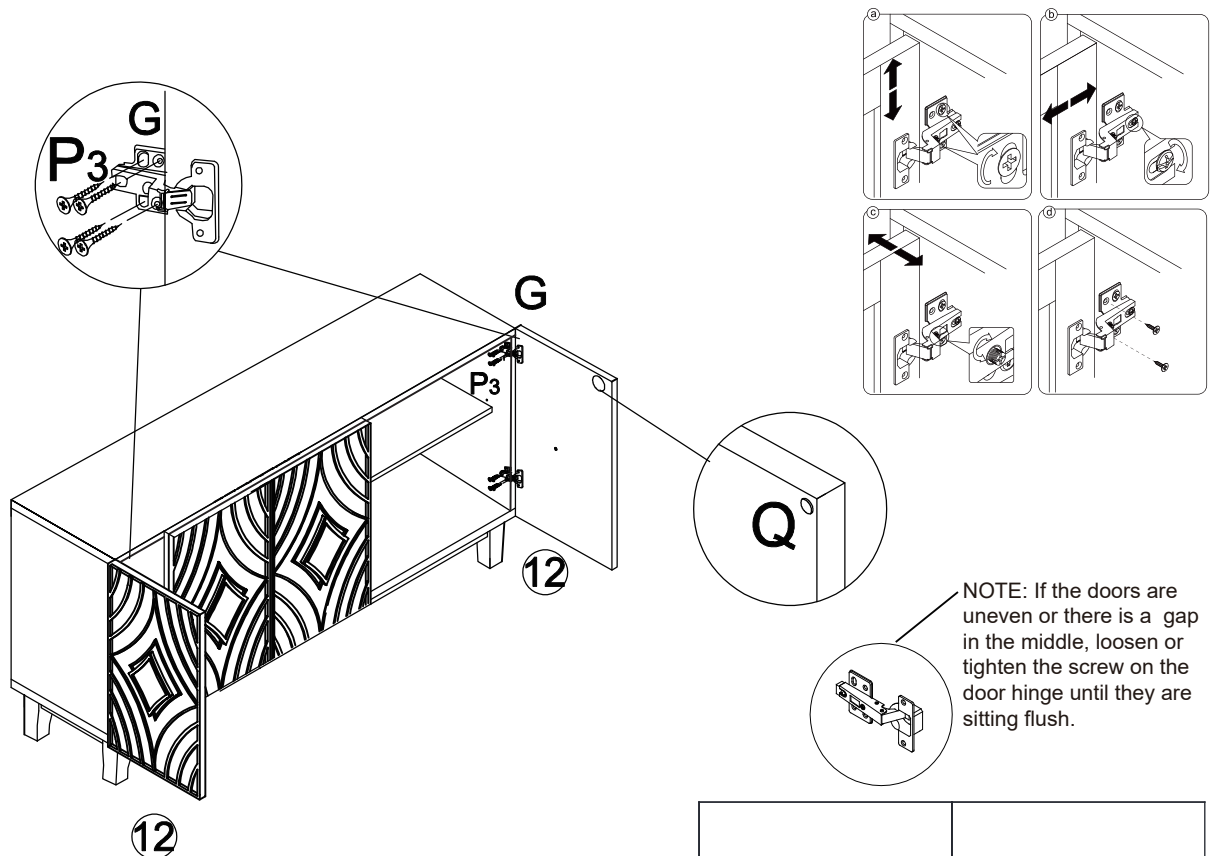

STEP 11



	
QX2	Ø 4 x 16mm
	P3 X 16

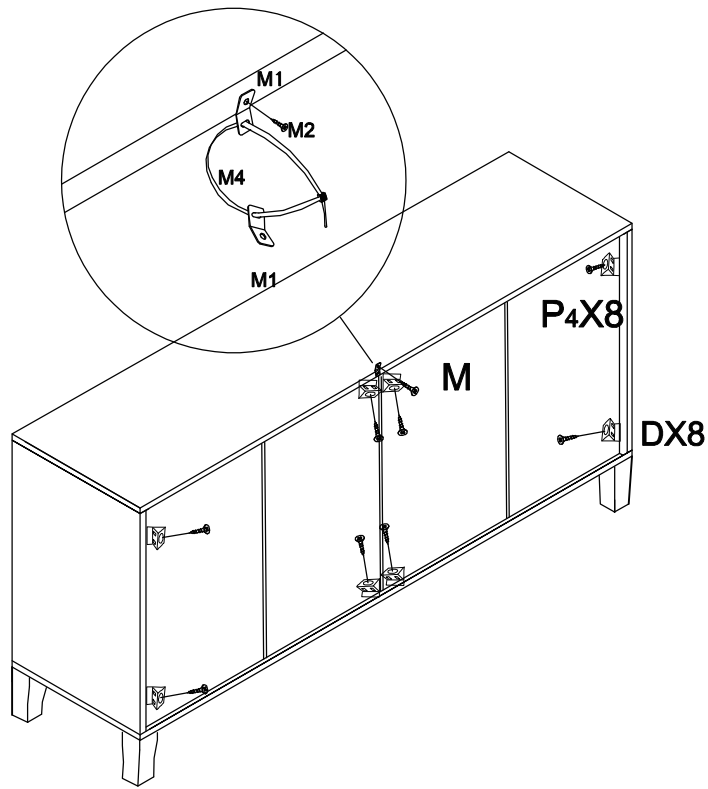

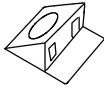
STEP 12

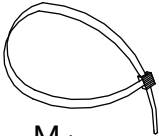

		 X2		
Ø3x14mm		M ₁	M ₂	M ₄
P ₄ X8	D X8			MX1

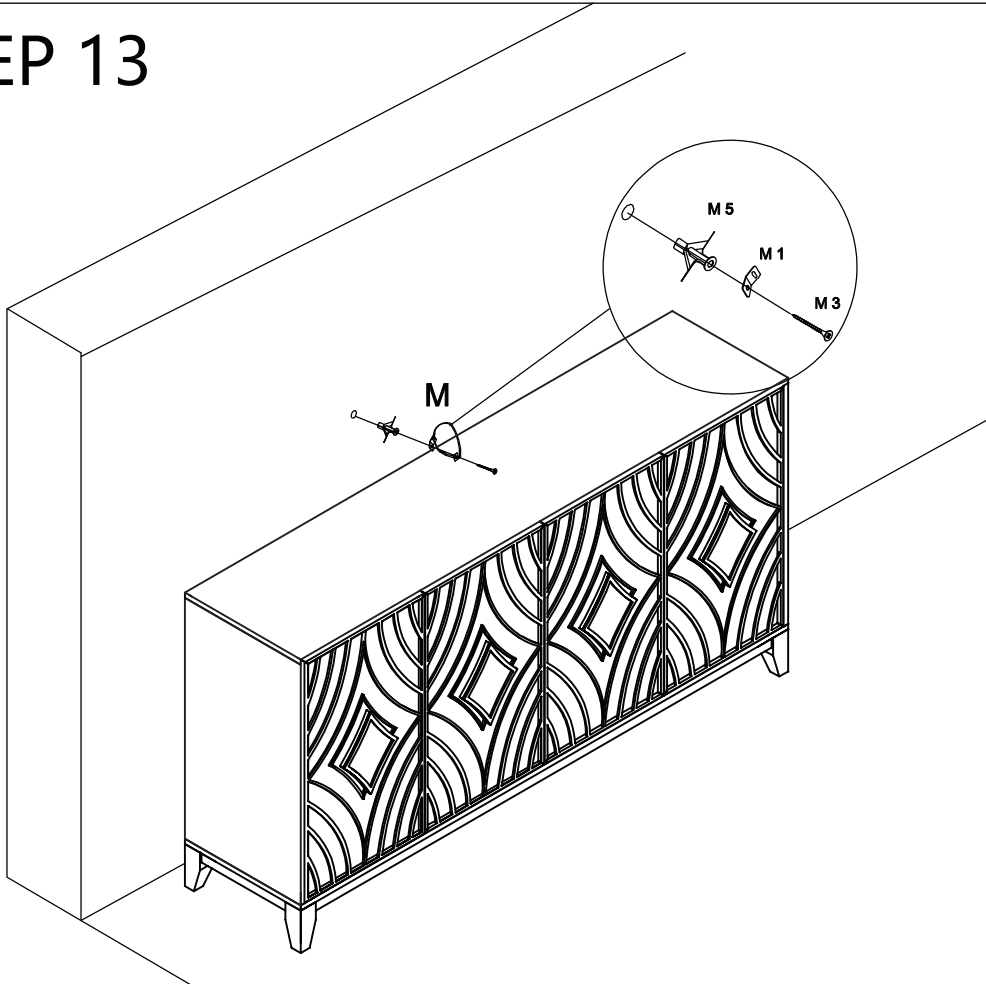
STEP 13



	
M ₃	M ₅
MX1	