

Recliner Assembly Instructions

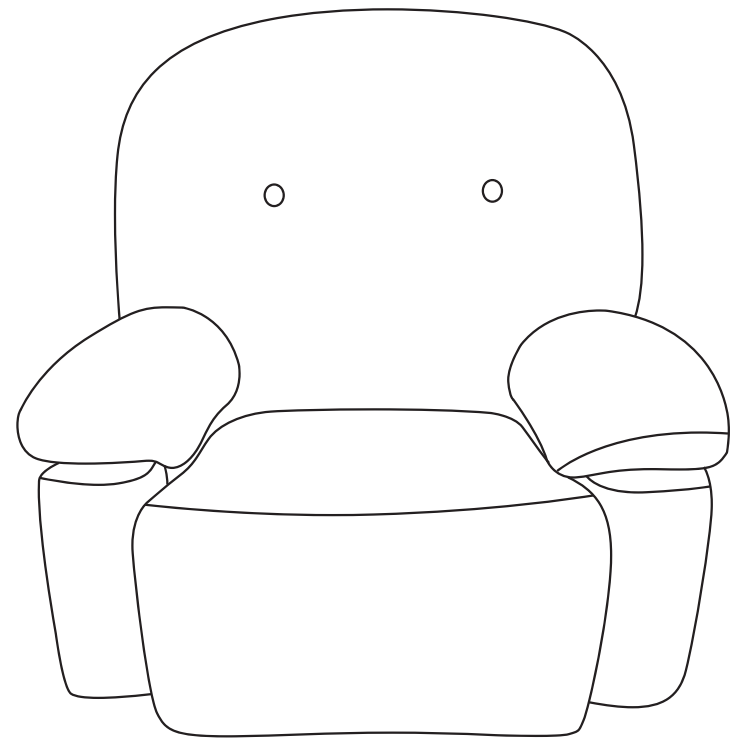

Accessories Display

CAUTION: Please check and ensure all the things are in the package. You can contact us if something is not included. We will reply within 24 hours and try our best to solve it.

- * Backrest and armrests are packed in a compression bag
- * The backrest you received has been vacuum-packed. Open the plastic bag and take out the backrest. Gently pat it for a while and make it more puffy.
- * **Able to recover up to 95% of its elasticity after a maximum of 7 hours.**

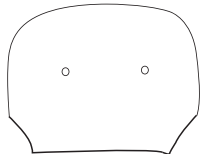

1. Back Cushion* 1pc



2. Back Frame* 1pc

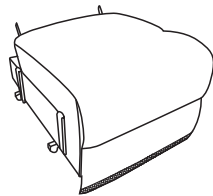

3. Seat* 1pc

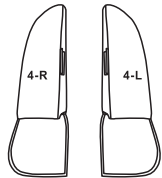

4. Backrest Ear Part* 2pc

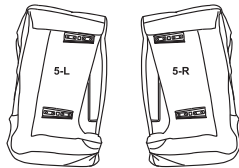

5. Armrest* 2pc

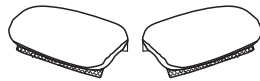

6. Armrest Pillow R&L* 2pc



A Remote Control *1pc

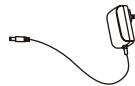

B Power Cord *1pc

* For the accessories in the pictures above, you will find them at the bottom of seatbase when you pull out the reclining handle.

Armrest Assembly

CAUTION: At least two adults are required to safely complete performing this task. Other lifting attempts may risk back injury due to large and heavy part(s).

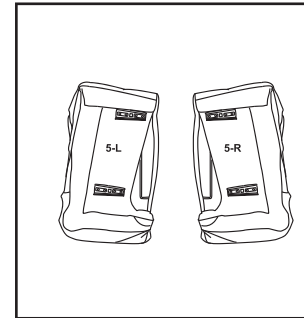

01 Find the accessories pictured on the left. Placed it on the ground for subsequent installation.



02 It is recommended to prop the armrests vertically.

Armrest Assembly

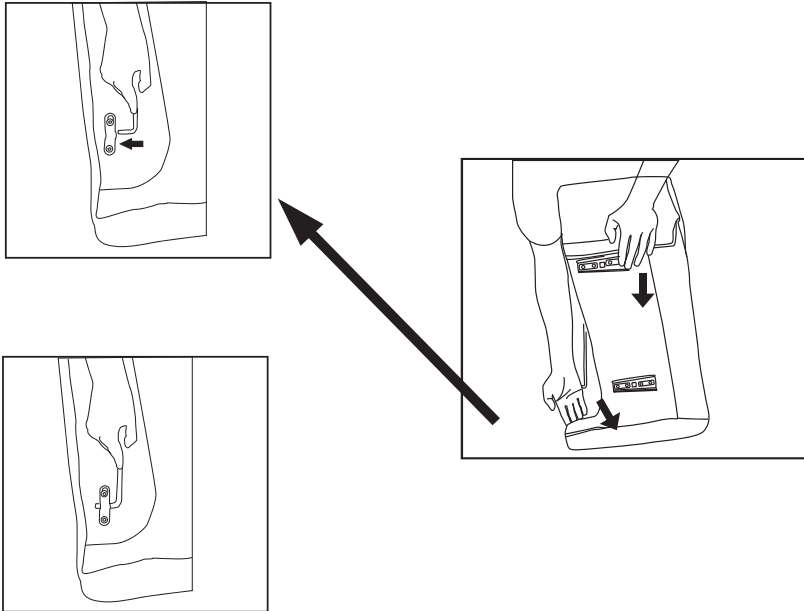

03 Place one hand on the short plate (red area) in the picture and push downward while placing the other hand on the green area to install the hook section as indicated in the picture.

Armrest Assembly

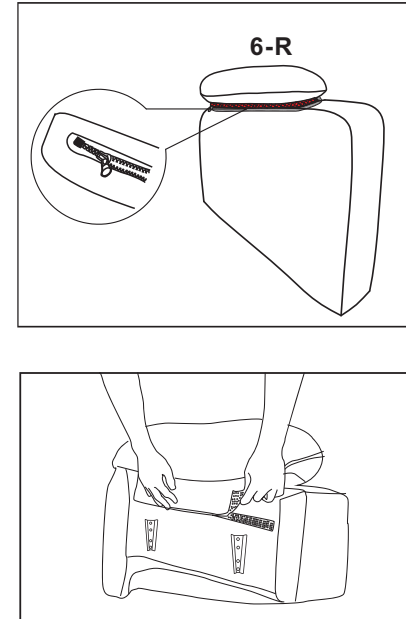

04 Align accessory **6-R** with the zipper on the armrest to complete the installation;

The other armrest bag is installed in the same way;

05 Paste accessory **6-R** on the Velcro back of the armrest to complete the installation;

The other armrest bag is installed in the same way.

Seating Assembly

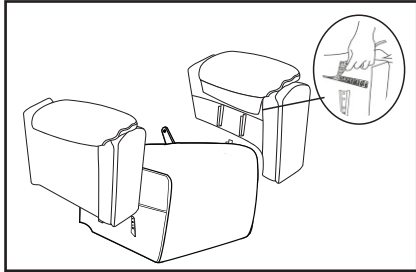

01 Align the pins on the armrest with the pins on the seat, and push down to install the armrest on the seat;

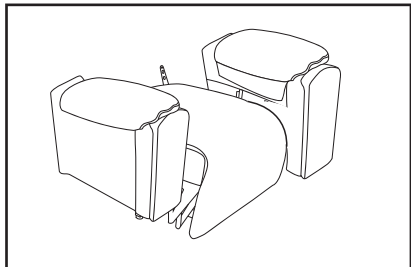

02 The installation is the same on the other side.

Backrest Assembly

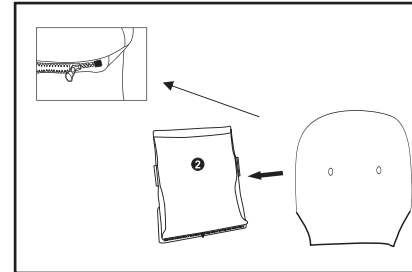

01 Assemble Part **1** and Part **2** and zip them up;

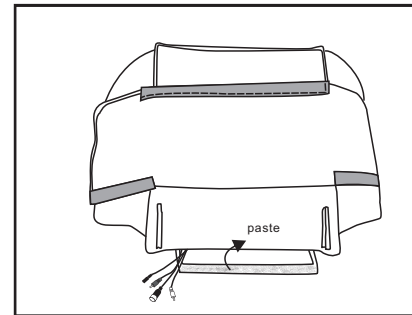

02 Sort out the wires and the power cord and put them outside the backrest, then attach the velcro.

Sofa Assembly

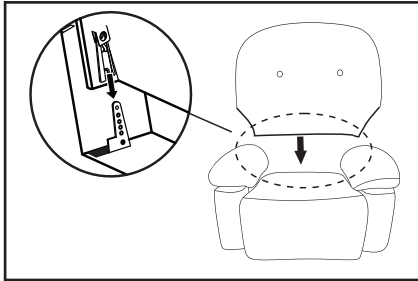

- 01** Align the pins of the backrest with the pins of the seat, and press downward to assemble the backrest and seat; Try shaking the backrest after installation, if one side wobbles up and down, it is not fully assembled.

Please make sure to hear a 'click' sound

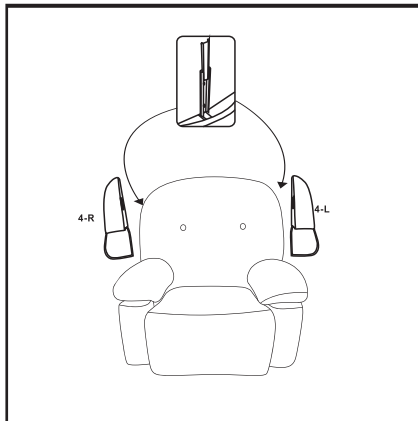

- 02** Assemble the part **4-R** by aligning the metal bolts on it with the metal bolts on the back of the backrest;

Assemble the other side in the same way;

Wire Assembly

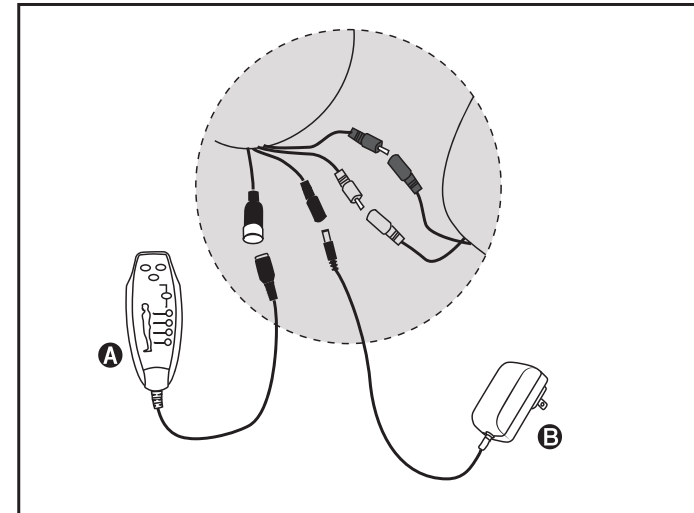

- 01 Swivel Rocker/Manual Recliner**

Connect the wires separately by their color. The white and red wires control massage and heating respectively.

USAGE

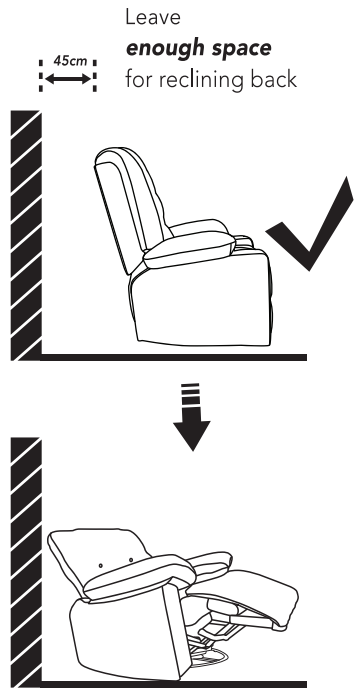

The recliner should be placed 45cm away from the wall, and the reclining function can be used normally.

PROPER USAGE



01 Steps to safely stand up from your Recliner Chair

1. Store the remote control safely in the side pocket of the seat
2. Place your feet firmly on the ground
3. Distribute the weight of the chair evenly between the arms
4. Stand up slowly from an upright position

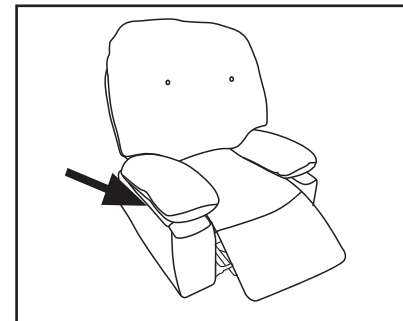

02 *Remember to store remote control safely in the side pocket when it is not in use.

*Fabrics will fade or discolor in direct sunlight, please minimize direct sunlight to extend the life of the furniture.

IMPROPERUSAGE

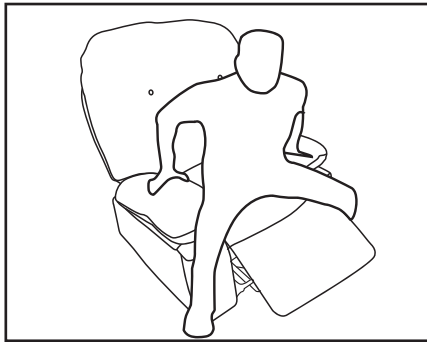

01 DO NOT
stand up when the footrest
is in the upright position.

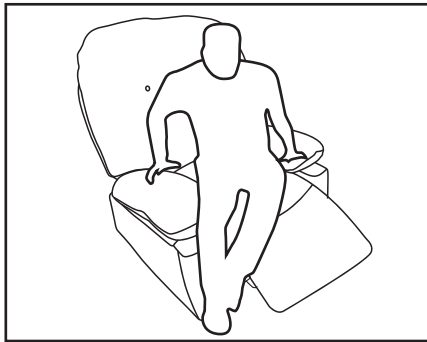

02 DO NOT
stand up from your recliner chair
with uneven weight.



03 DO NOT
stand up from your recliner chair
with only one arm.

IMPROPERUSAGE

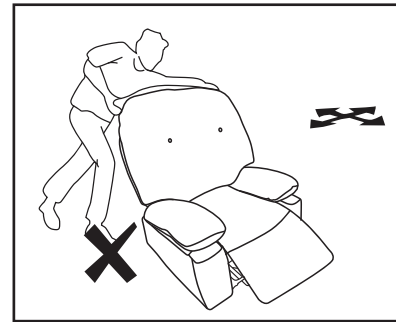

04 Please handle with care as the product
contains moving parts.

* Only move the recliner when it is in the 'upright' or 'closed' position. Never attempt to move the recliner when it is in any of the reclining positions. Always use the arms to move the Recliner-DO NOT use the backrest or backrest ear parts.

WARRANTY

So glad you have completed the assembly and can enjoy it. If you are satisfied with our products, thank you for showing your favored massage recliner to your around.

Our products come with a 2-month warranty, you can feel free to contact us at any time.

Methods:

If you choose Amazon, going to your Amazon order detail page Order>sold by>contact seller (guaranteed response within 24 hours)

If you choose other platform, please contact us by:

Email:service@wyidaseat.com(Please indicate the shopping platform you are using and the platform order number, we will reply to you within 24 hours).

AFTER-SALE POLICY

1.For return reason:

Wrong purchase, bought by mistake, no longer needed, doesn't meet expectation, a size smaller than expectation, customer need to cover the return shipping fee.

2.For cancel order:

Customer needs to pay for shipping fee and carrier handle fee if the item has been shipped out. For change address: customer needs to pay for extra shippingfee and carrier handle fee if the item has been shipped out.

3.Customer Service:

Any problem with the product or shipping issue, please feel free to contac us, we will try our best to serve and help.

Dear Customer,

Thank you for choosing us.

For safe use, please read this manual before installation, and keep it for after use.Please feel free to email us if you have any concerns about our products. We'll reply within 24 hours.

The following are the things you need to pay attention to so that we can provide you with services when you encounter problems during the installation and use of the product:

- When the product is damaged due to courier problems, please contact our customer service in time for verification.
- We will rectify the issue as soon as possible;
- We provide a 7-day no-reason return service (note that the returneo product will not affect the secondary sales);

We offer product explanations, installation instructions, product maintenance and maintenance methods.

If you feel satisfied with our product and service,

- Please set our store as your favorites;
- Please recommend our products to your friends;
- Please and leave us your purchase experience in our store or product page.

Feedback or reviews from you will greatly help us offer better services to players around the world.

Best regards

Avoid using sharp objects such as a knife to cut open packing as you may accidentally damage the upholstery.

E-mail:service@wyidaseat.com

www.wyidaseat.com