

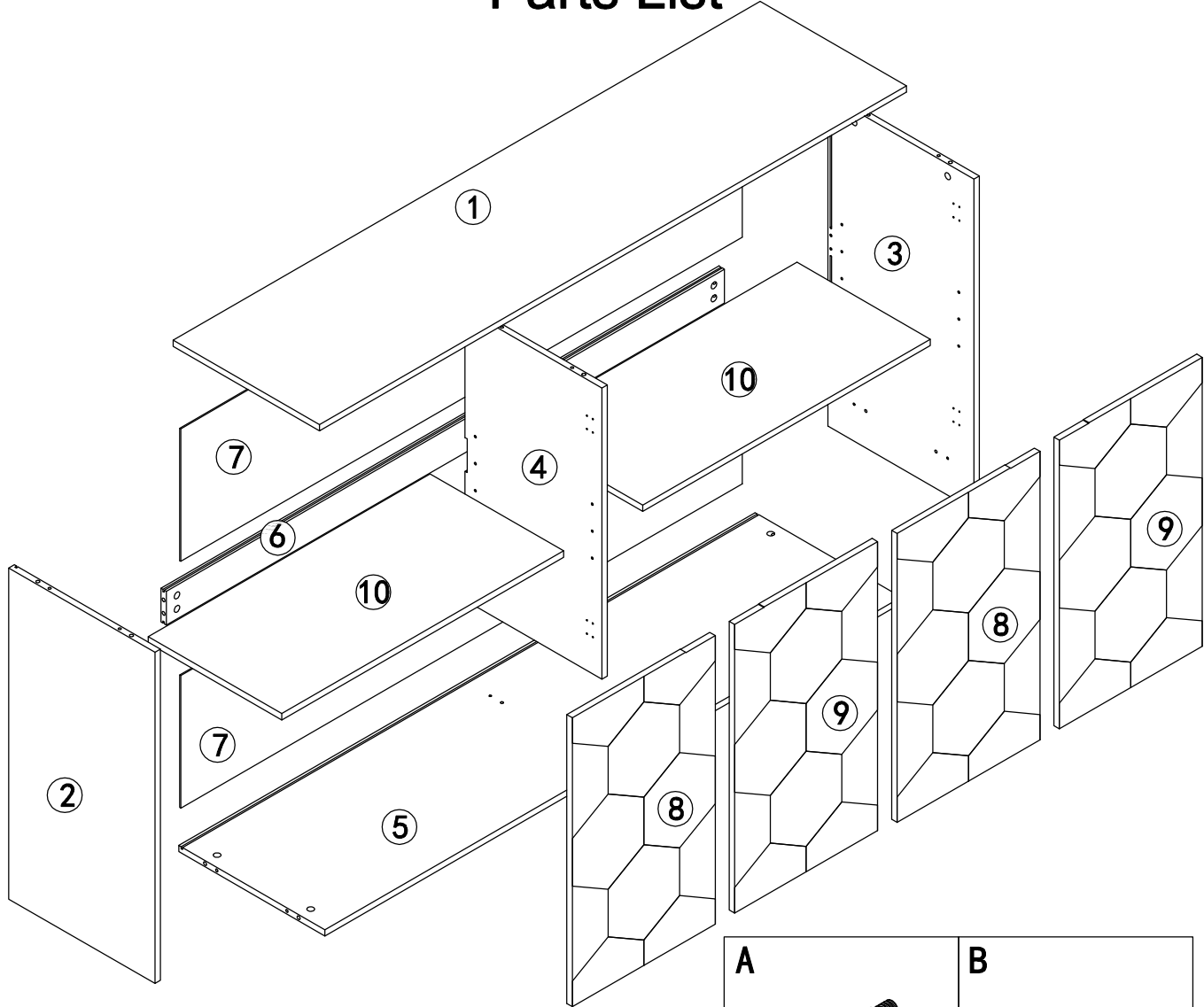









# Parts List

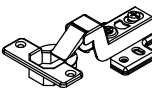

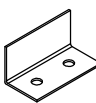
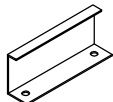
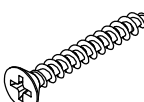
<p><b>A</b></p>  <p>16pcs</p>	<p><b>B</b></p>  <p>16pcs</p>			
<p><b>C</b></p>  <p>12pcs</p>	<p><b>D</b></p>  <p>4pcs</p>	<p><b>E</b></p>  <p>70pcs</p>	<p><b>F</b></p>  <p>8pcs</p>	<p><b>G</b></p>  <p>2pcs</p>
<p><b>H</b></p>  <p>4pcs</p>	<p><b>I</b></p>  <p>5pcs</p>	<p><b>J</b></p>  <p>8pcs</p>	<p><b>K</b></p>  <p>2pcs</p>	<p><b>L</b></p>  <p>4pcs</p>
<p><b>M</b></p>  <p>2pcs</p>	<p><b>N</b></p>  <p>1pc</p>	<p><b>O</b></p>  <p>2pcs</p>	<p><b>P</b></p>  <p>4pcs</p>	<p><b>Q</b></p>  <p>4pcs</p>

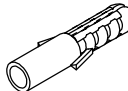
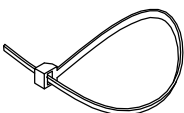
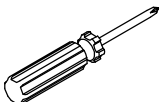
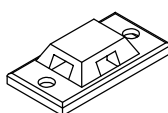
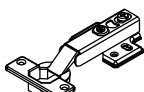
# Step 1:

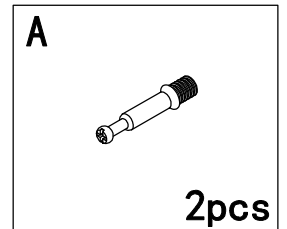
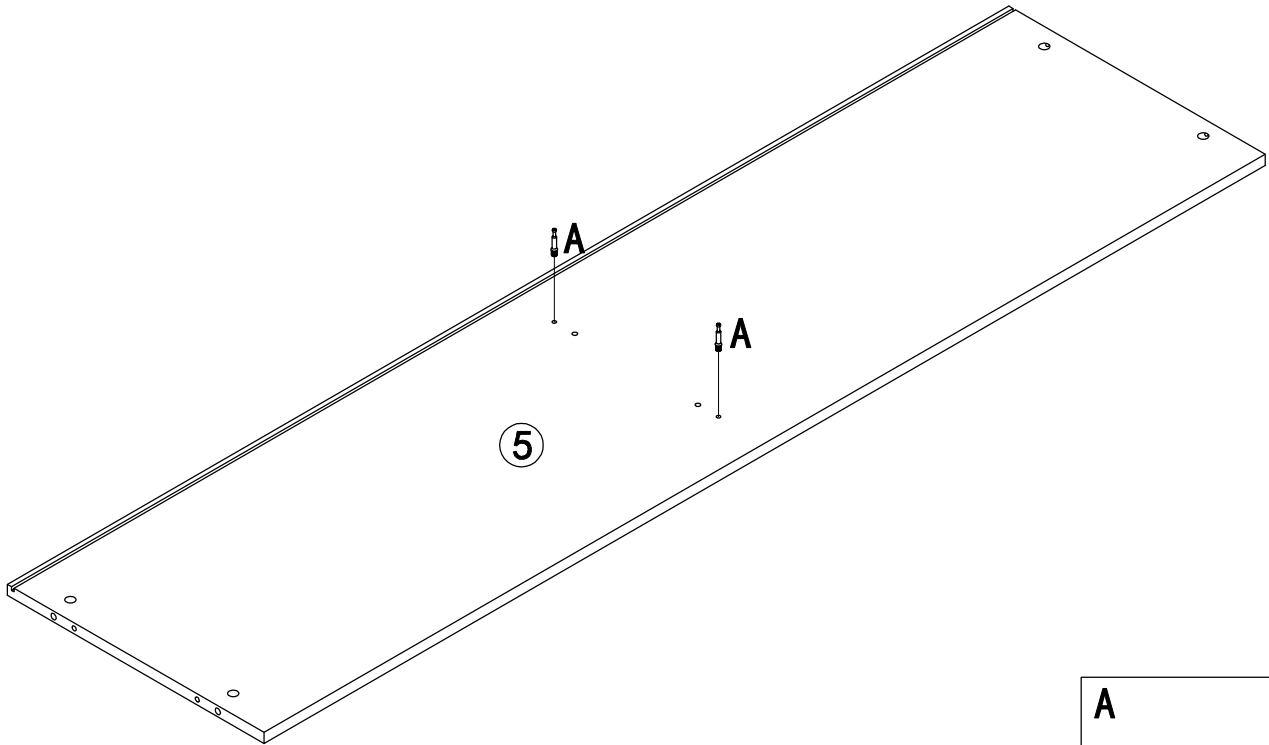

# Step 2:

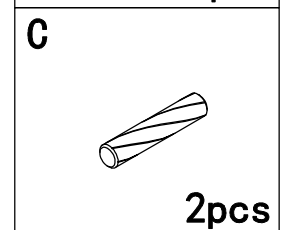
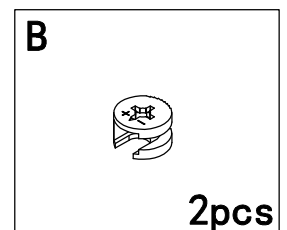
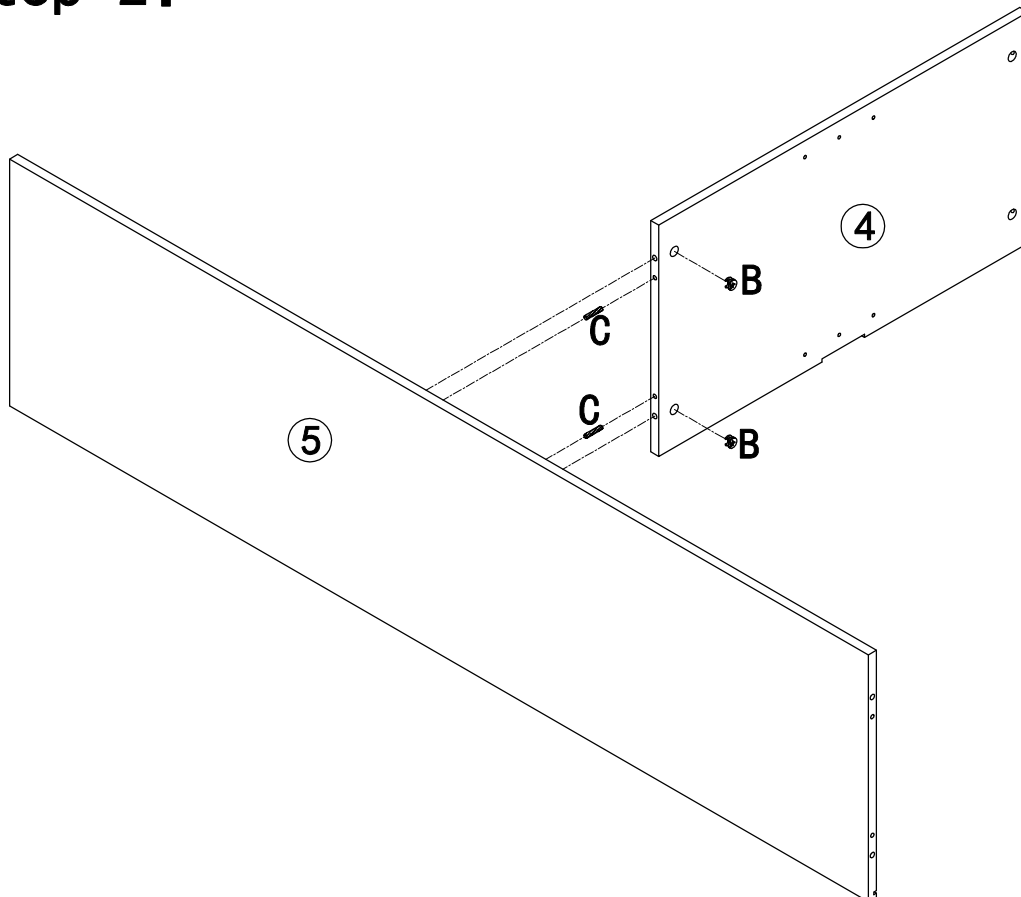

### Step 3:

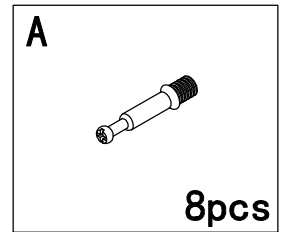
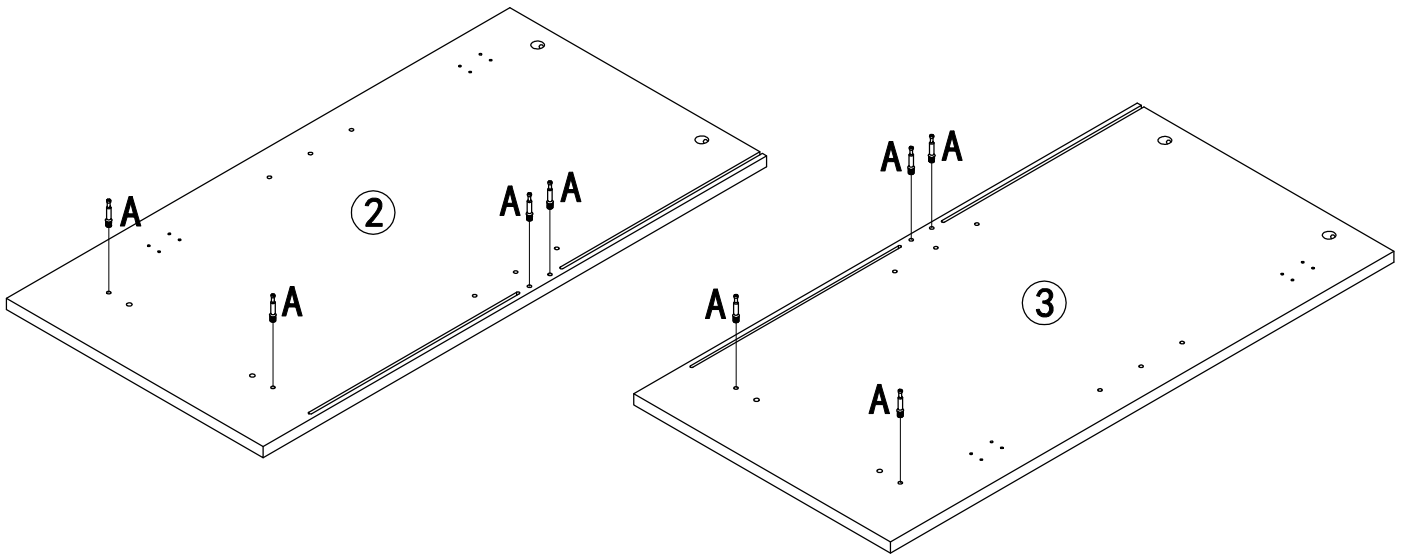

### Step 4:

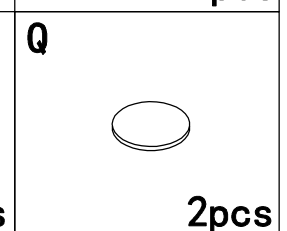
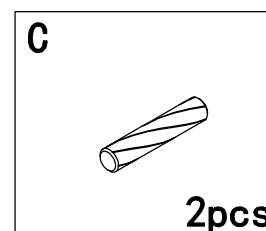
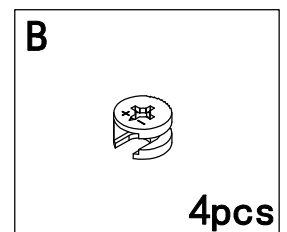
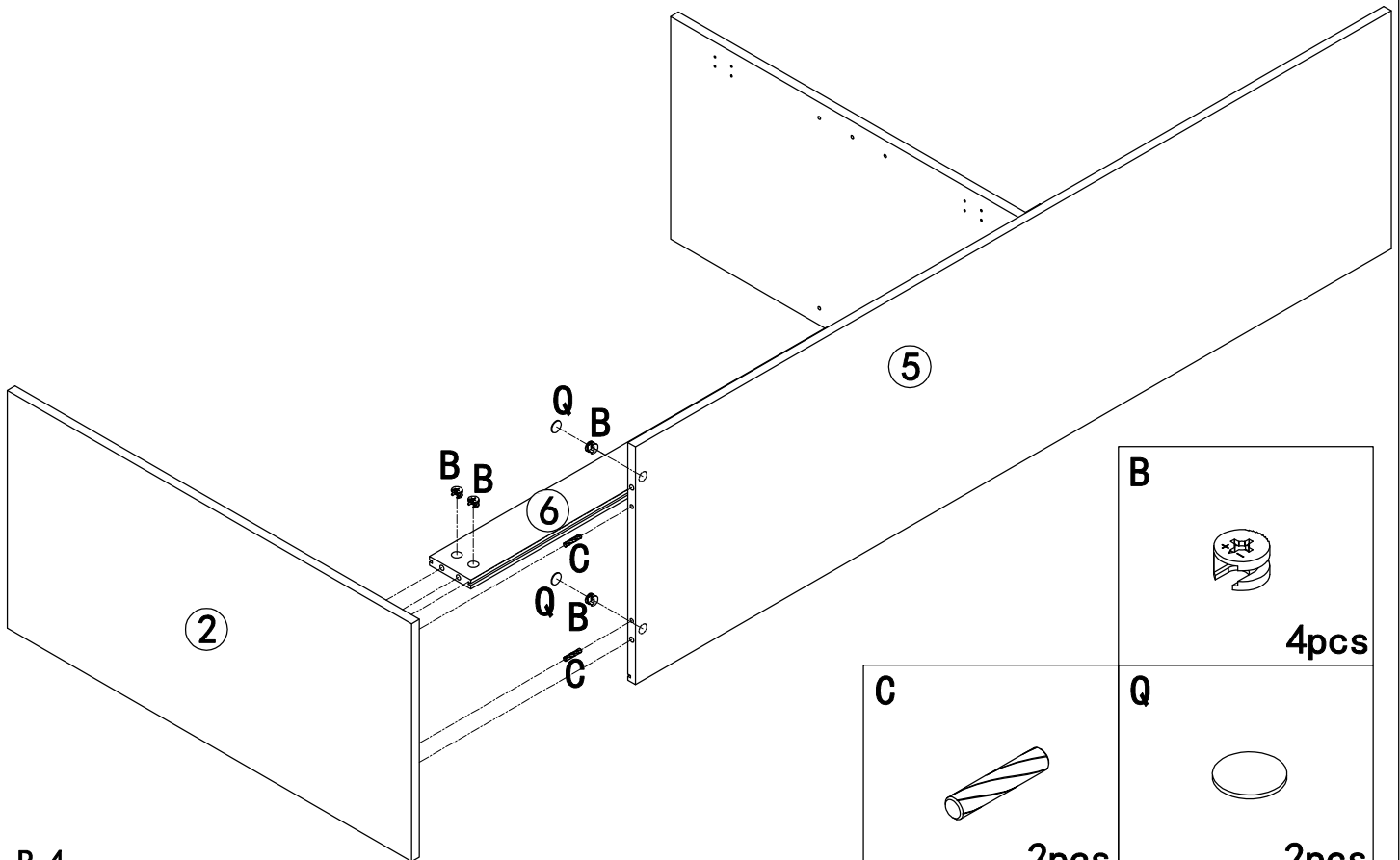

# Step 5:

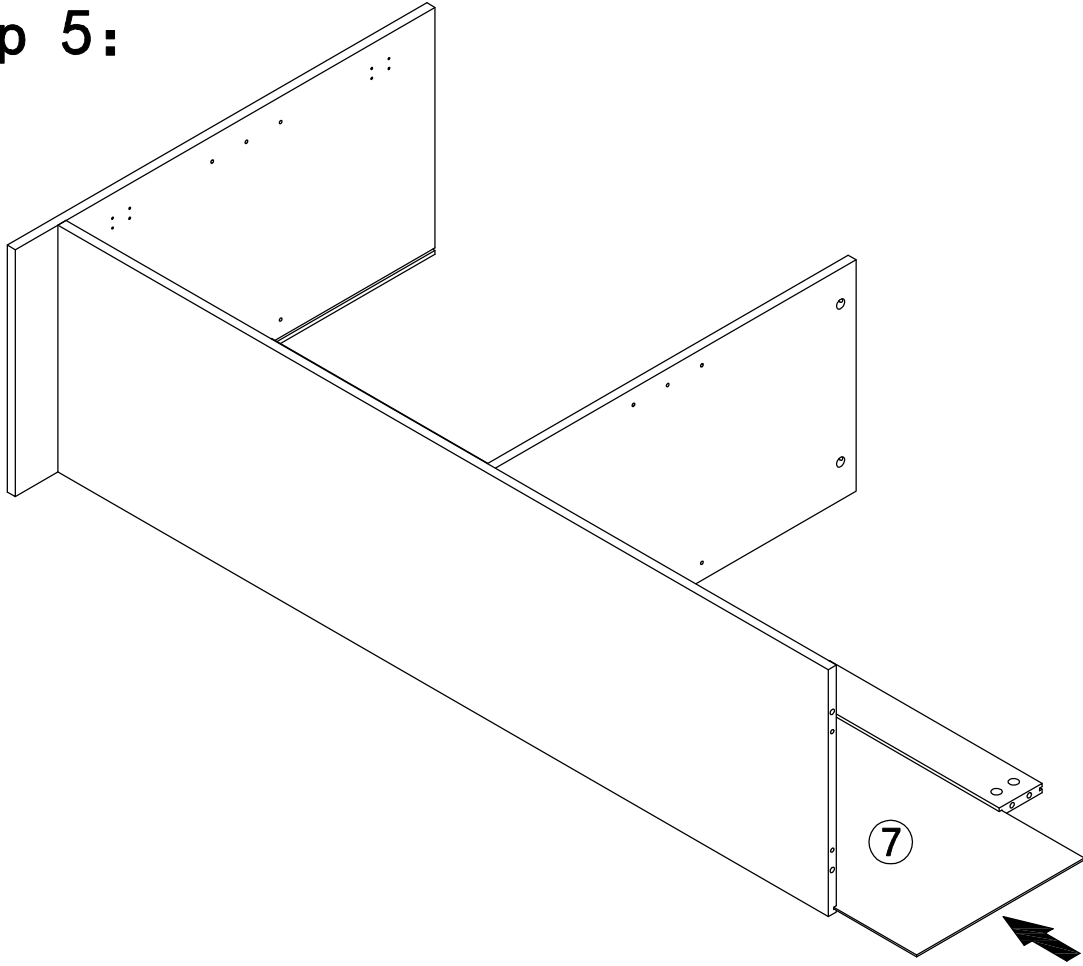

# Step 6:

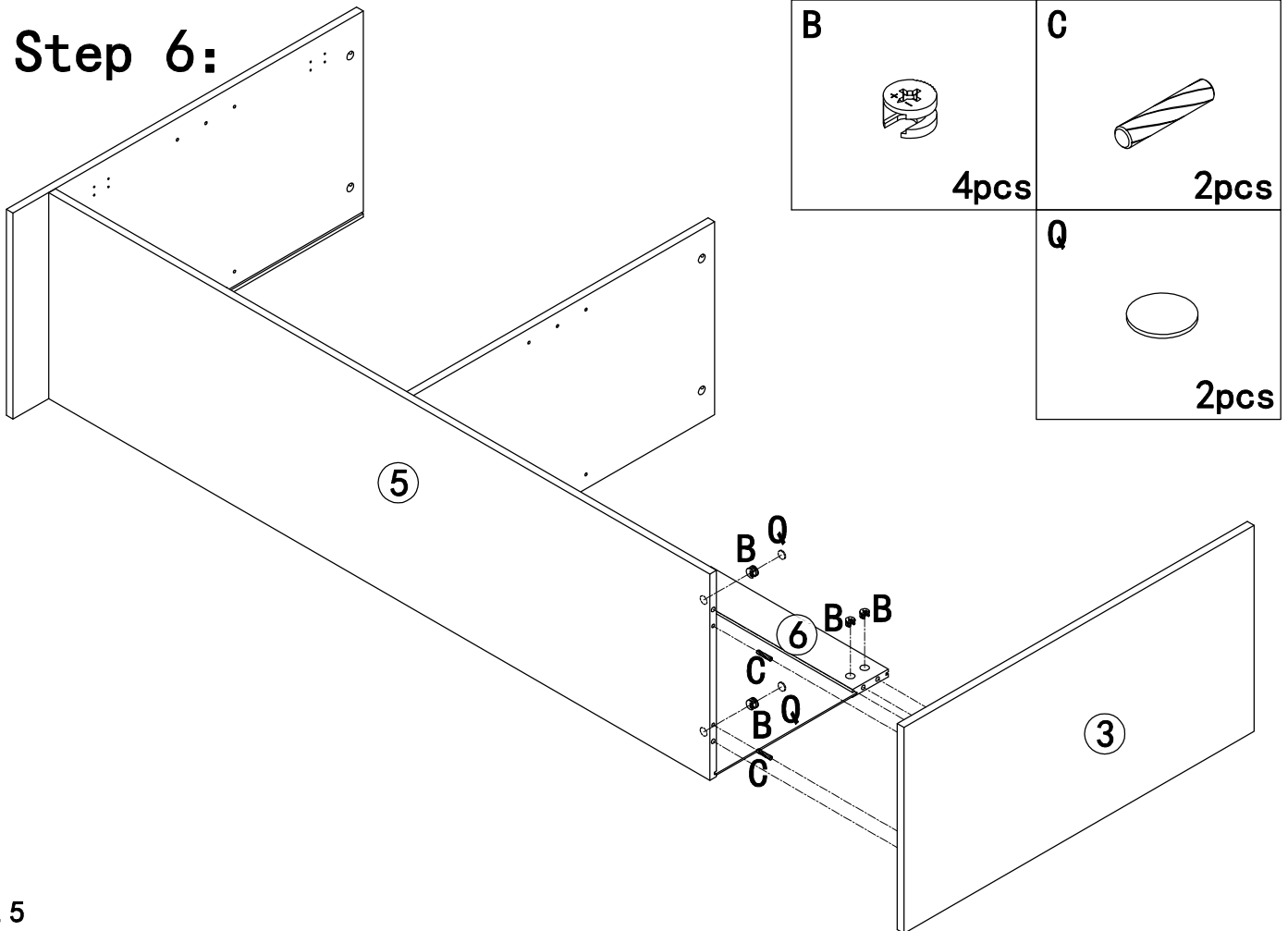

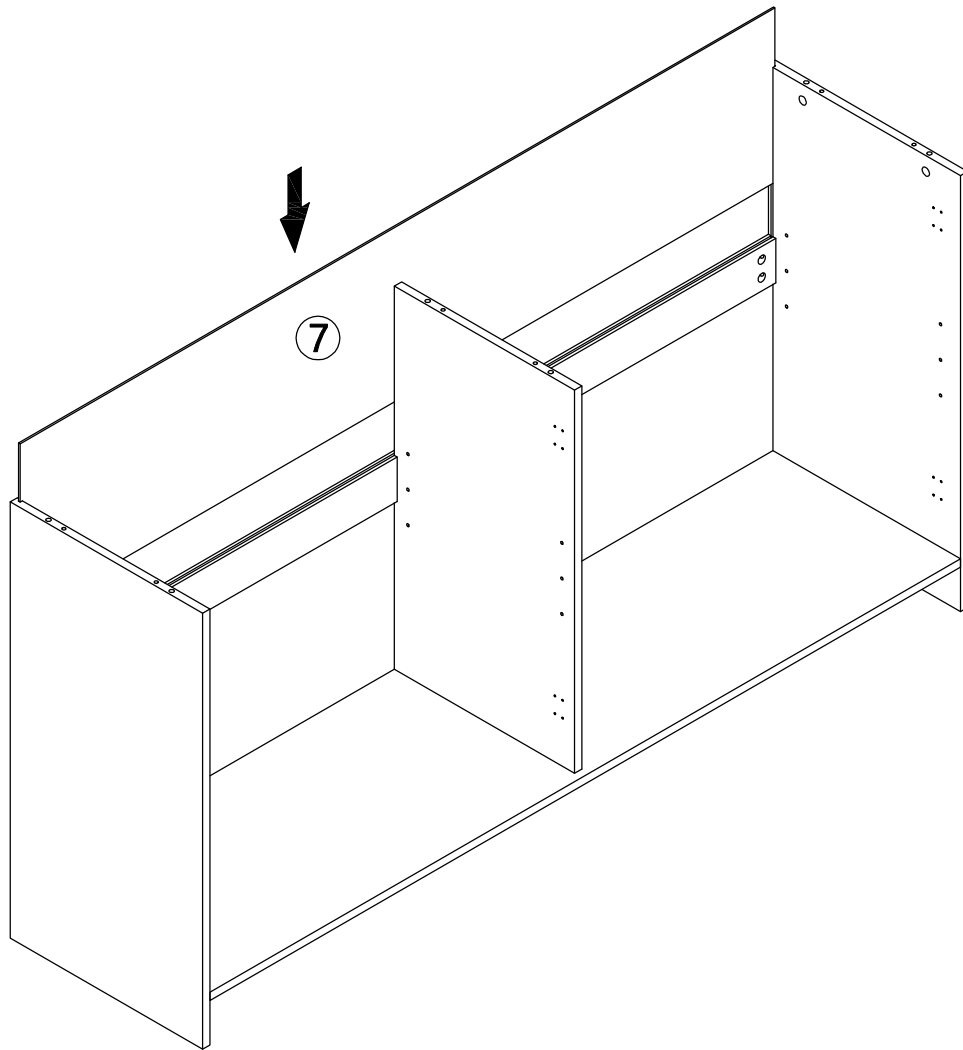

# Step 7:



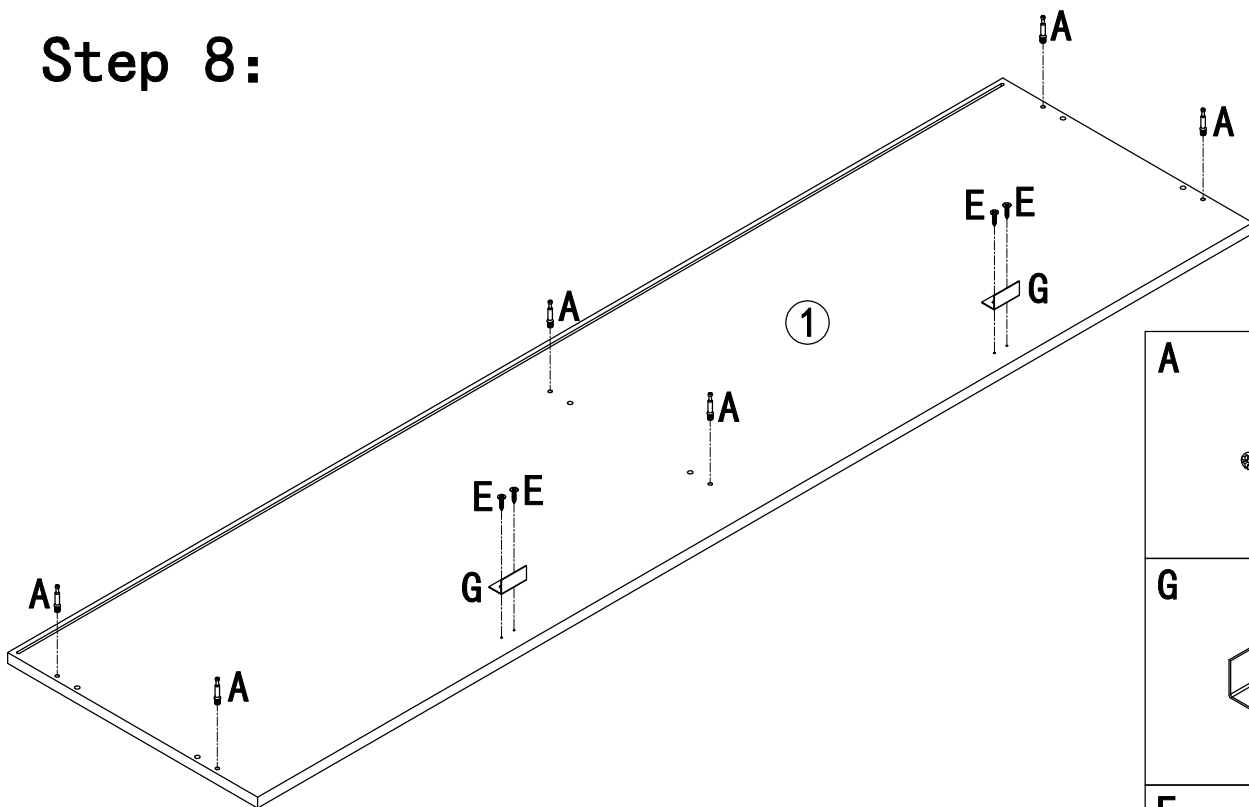

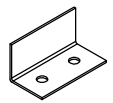
# Step 8:



A		6pcs
G		2pcs
E		4pcs

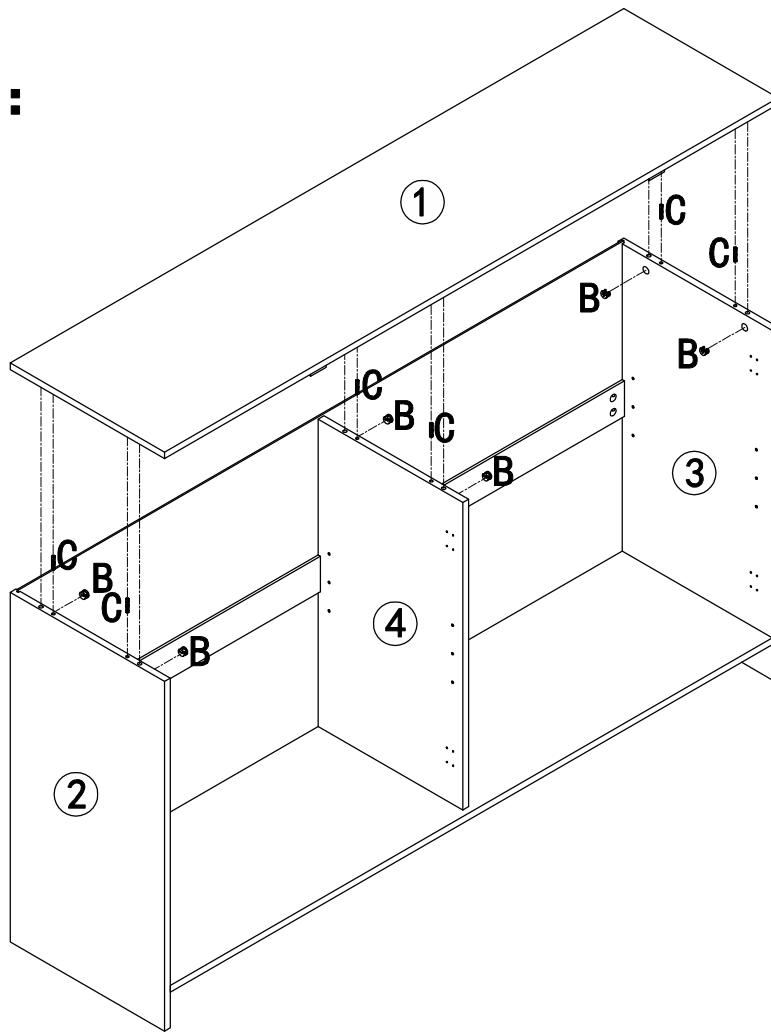

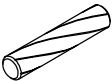

# Step 9:

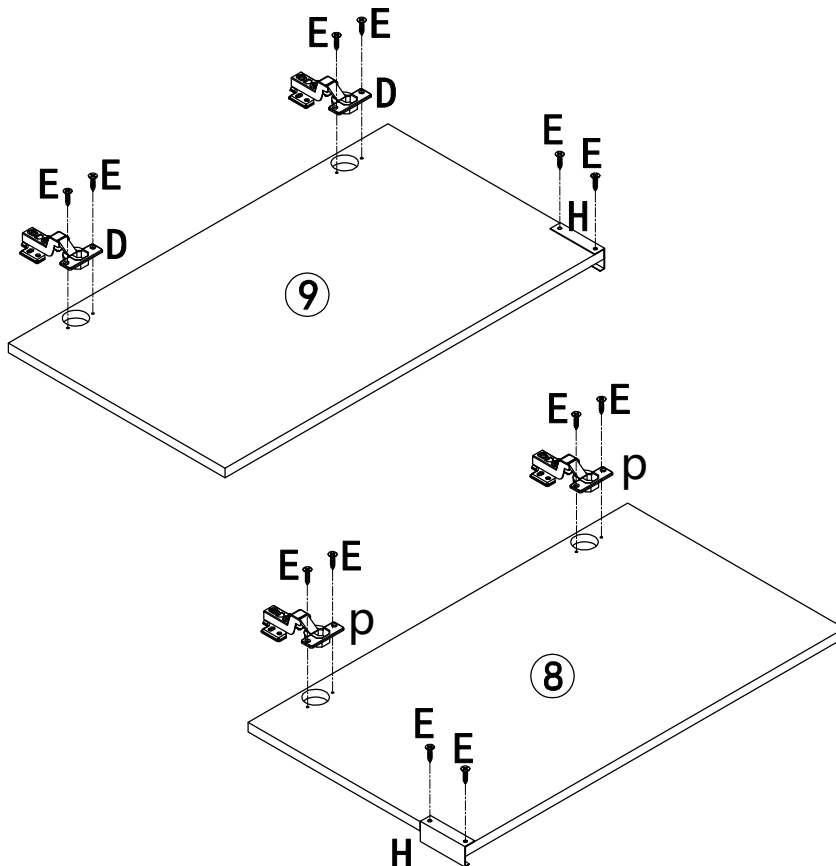

<p><b>B</b></p>  <p>6pcs</p>
<p><b>C</b></p>  <p>6pcs</p>

# Step 10:

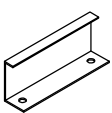

<p><b>D</b></p>  <p>2 pcs</p>
<p><b>E</b></p>  <p>12pcs</p>
<p><b>H</b></p>  <p>2pcs</p>
<p><b>p</b></p>  <p>2pcs</p>

# Step 11:

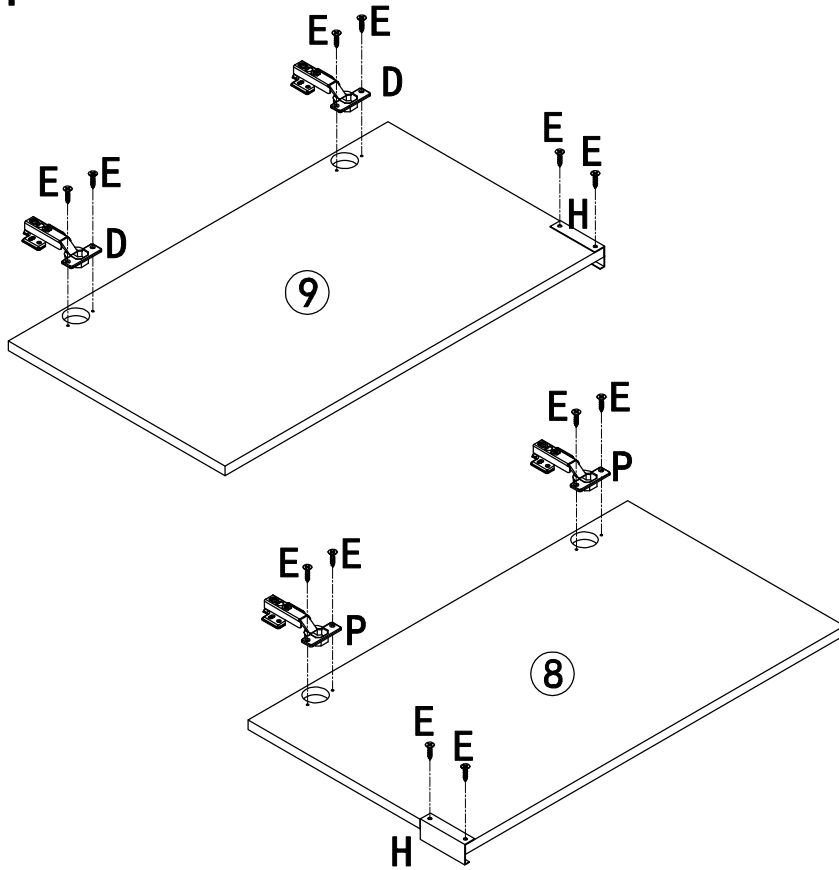

D		2 pcs
E		12 pcs
H		2 pcs
p		2 pcs

# Step 12:

USE HINGE D FOR THE 2 SIDE DOORS

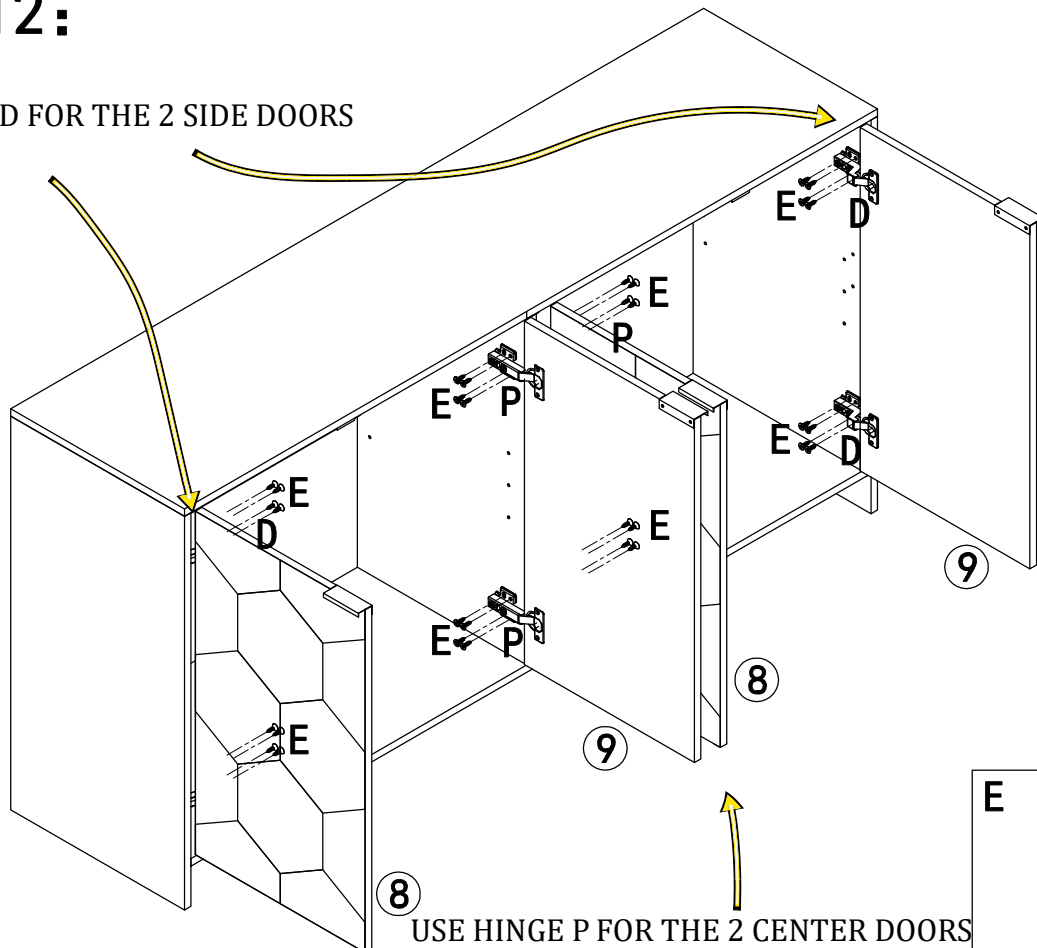

USE HINGE P FOR THE 2 CENTER DOORS

E		32 pcs
---	--	--------



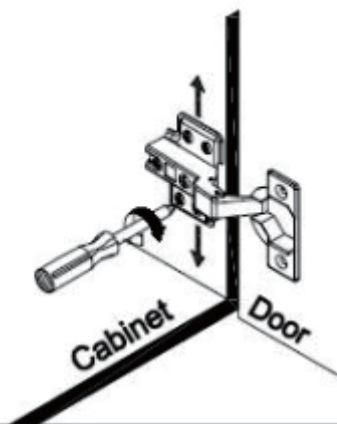
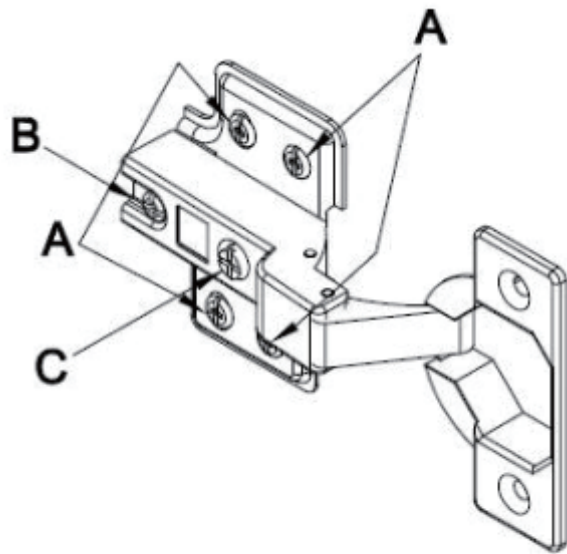

**To adjust the vertical height.**

Loosen the four screws "A" on both hinges. Two of them are usually in slotted holes which allows you to adjust up or down by a few mm. Then tighten back up.

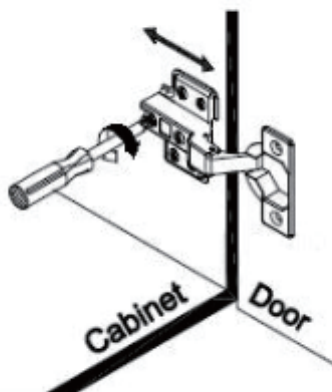

**To adjust depth.**

Loosen screw "B" and adjust door, if the door can not be adjusted, please loosen screw "C", then try again. Tighten screw "B" and "C".

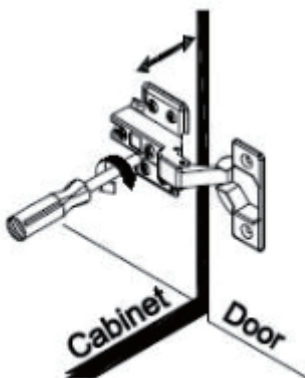

**To adjust side ways.**

Turning the screw "C" on BOTH hinges on each door.

# Step 13:

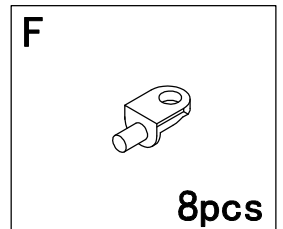
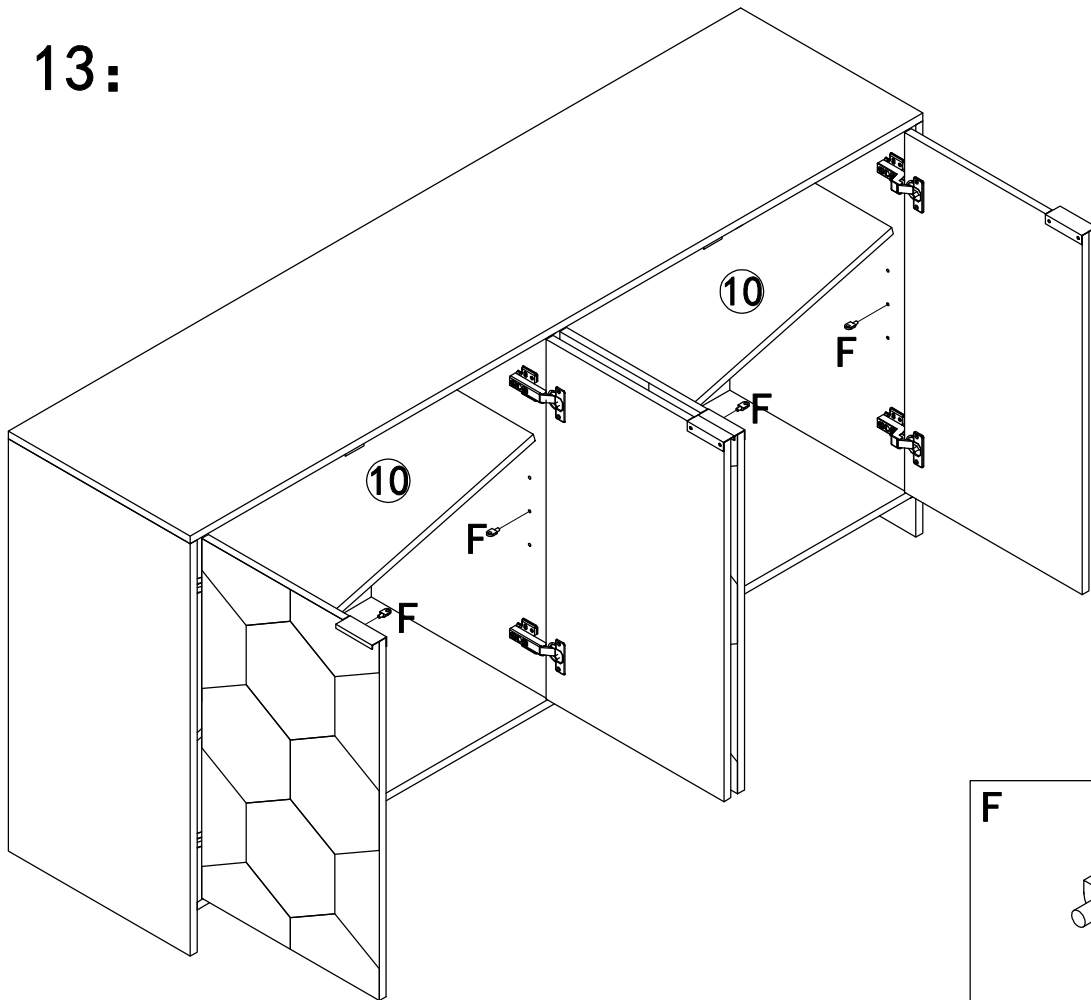



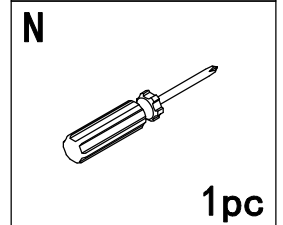
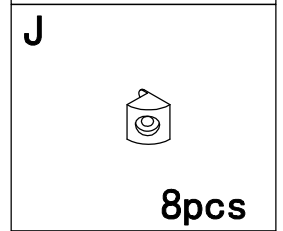
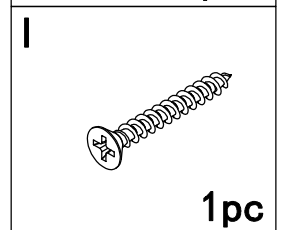
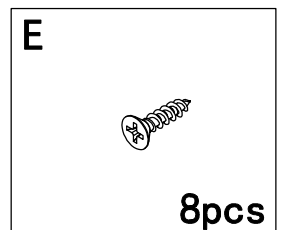
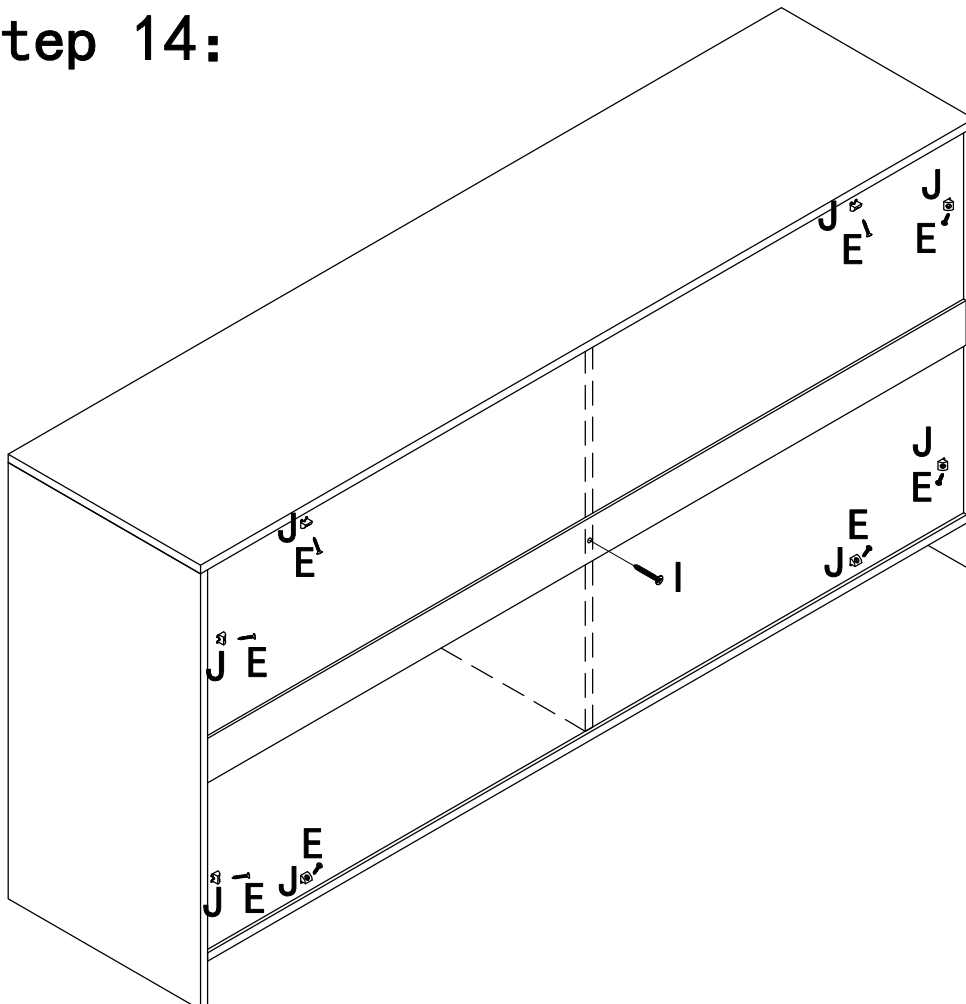

# Step 14:

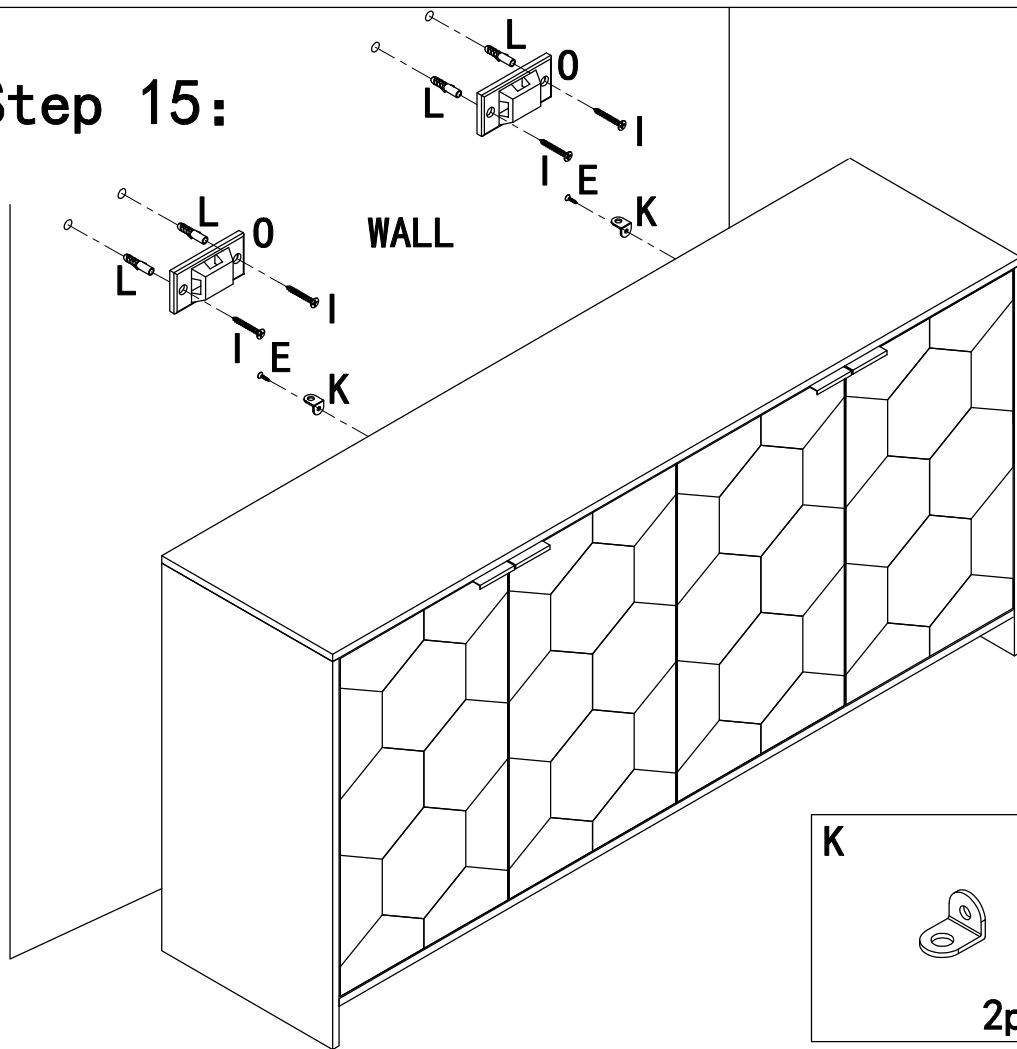

# Step 15:

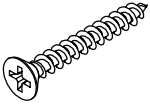

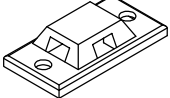
E		2pcs
L		4pcs
I		4pcs
K		2pcs
O		2pcs

# Step 16:

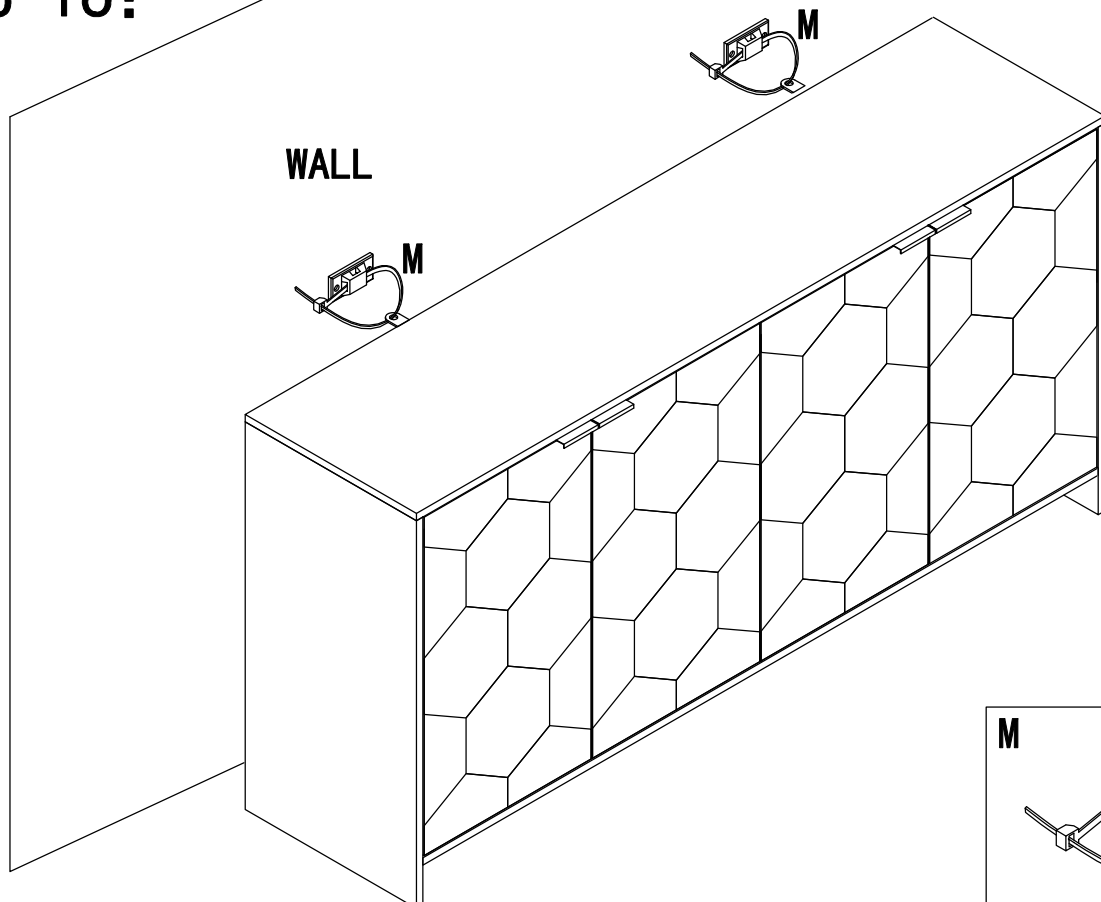

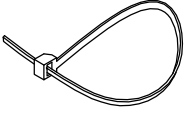
M		2pcs
---	---------------------------------------------------------------------------------------	------