

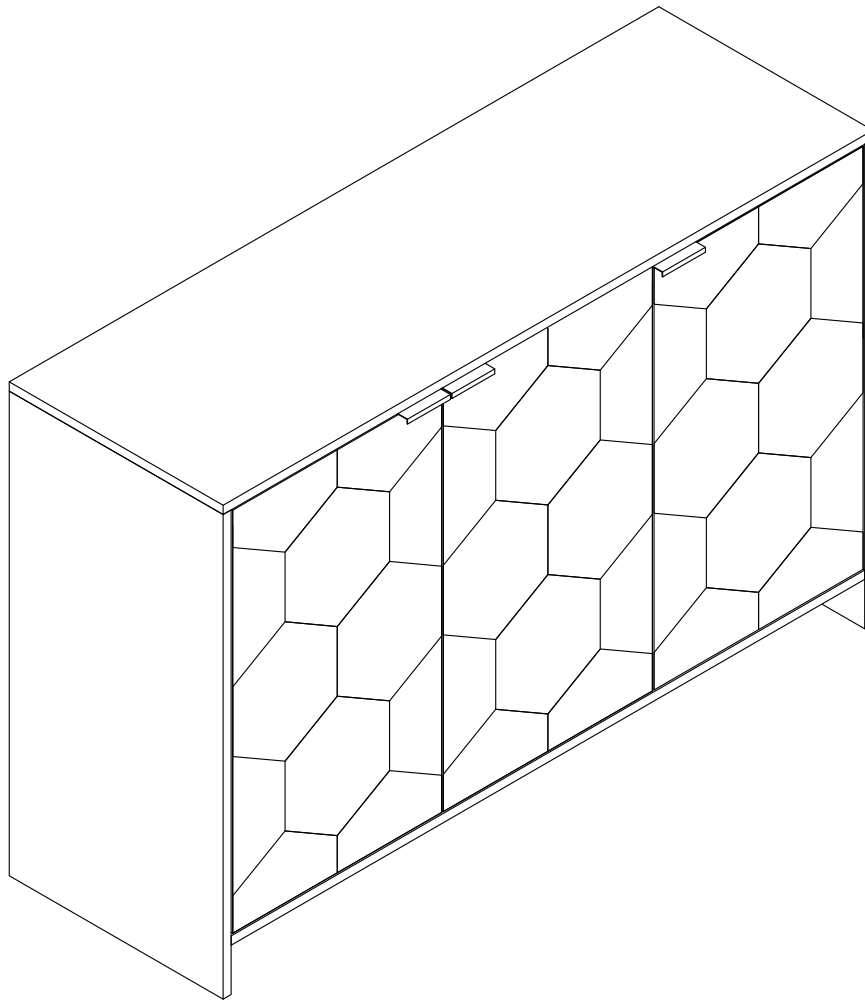

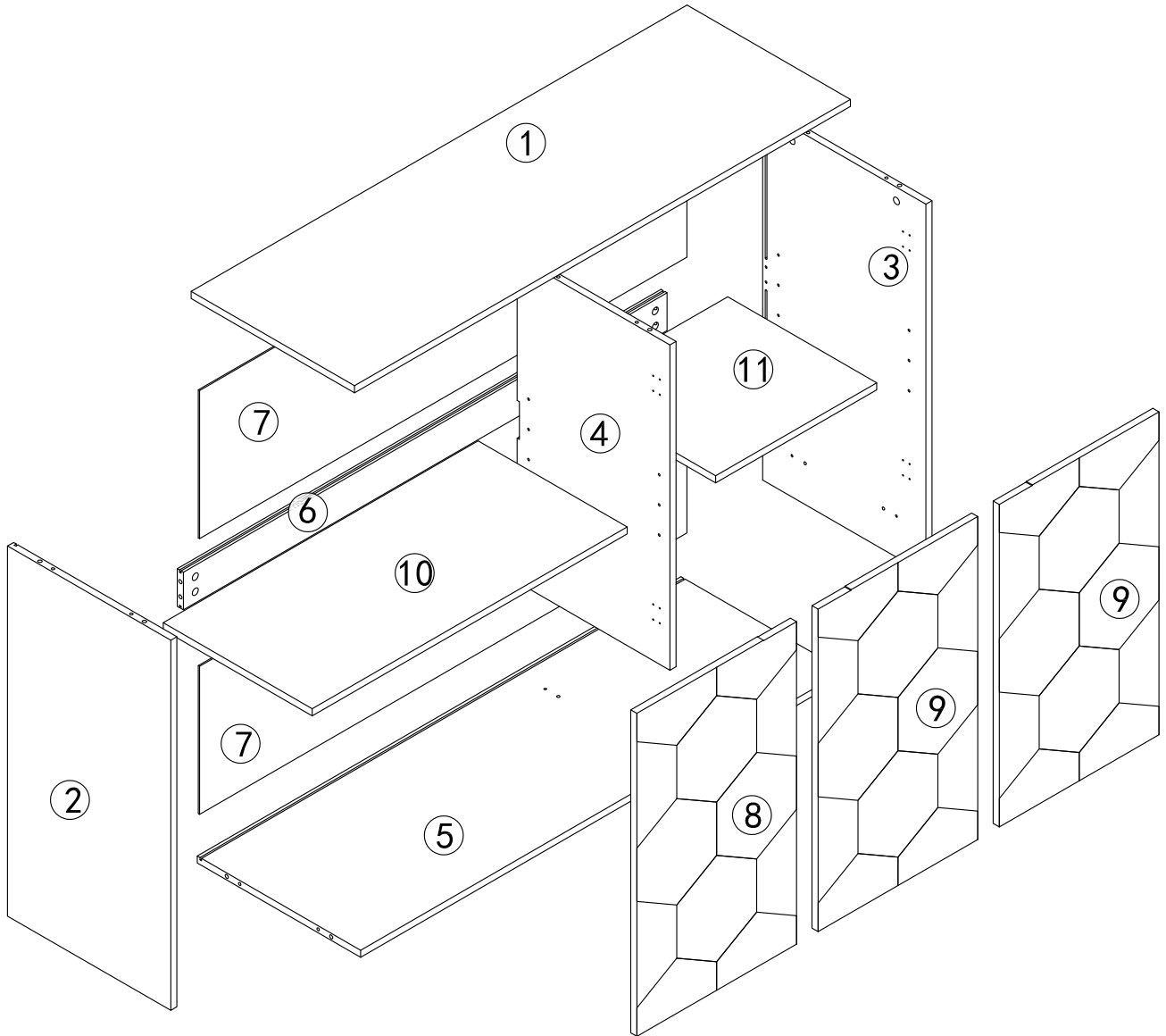

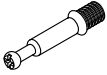



Assembly Instructions

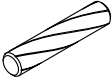
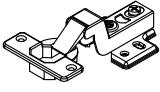

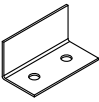
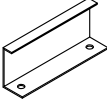
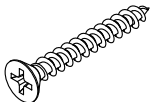
Parts List

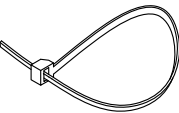
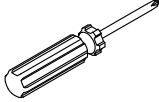

A  16pcs	B  16pcs	C  12pcs	D  6pcs	E  55pcs
F  8pcs	G  2pcs	H  3pcs	I  2pcs	J  8pcs
K  2pcs	L  1pc	M  1pc	N  1pc	

Step 1:

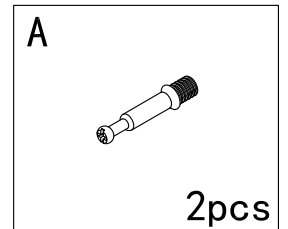
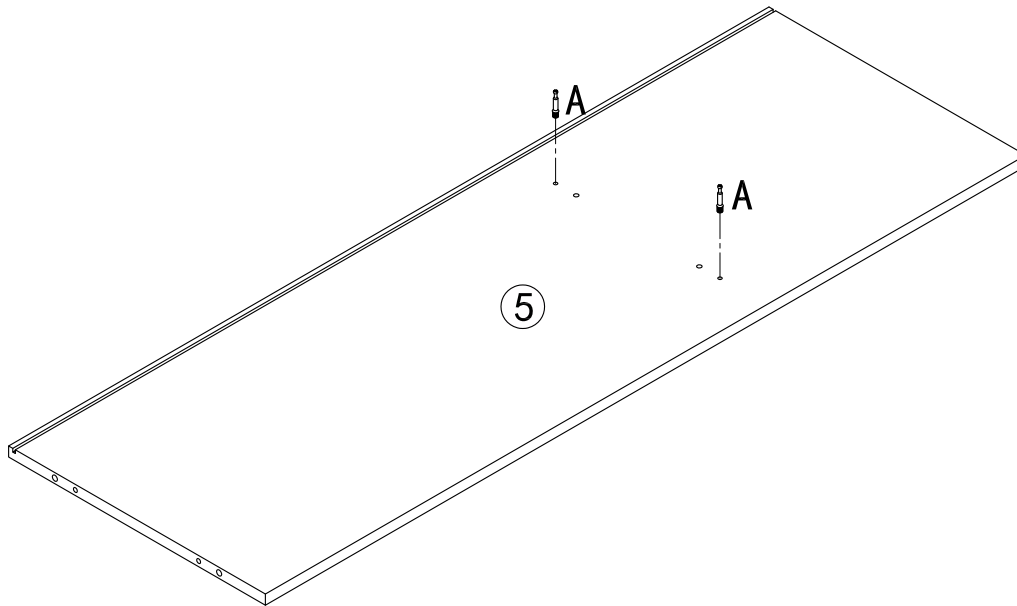

Step 2:

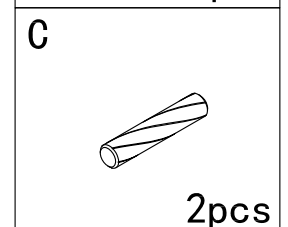
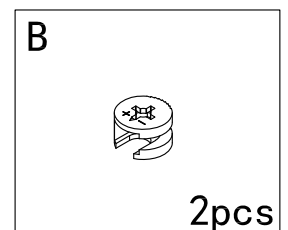
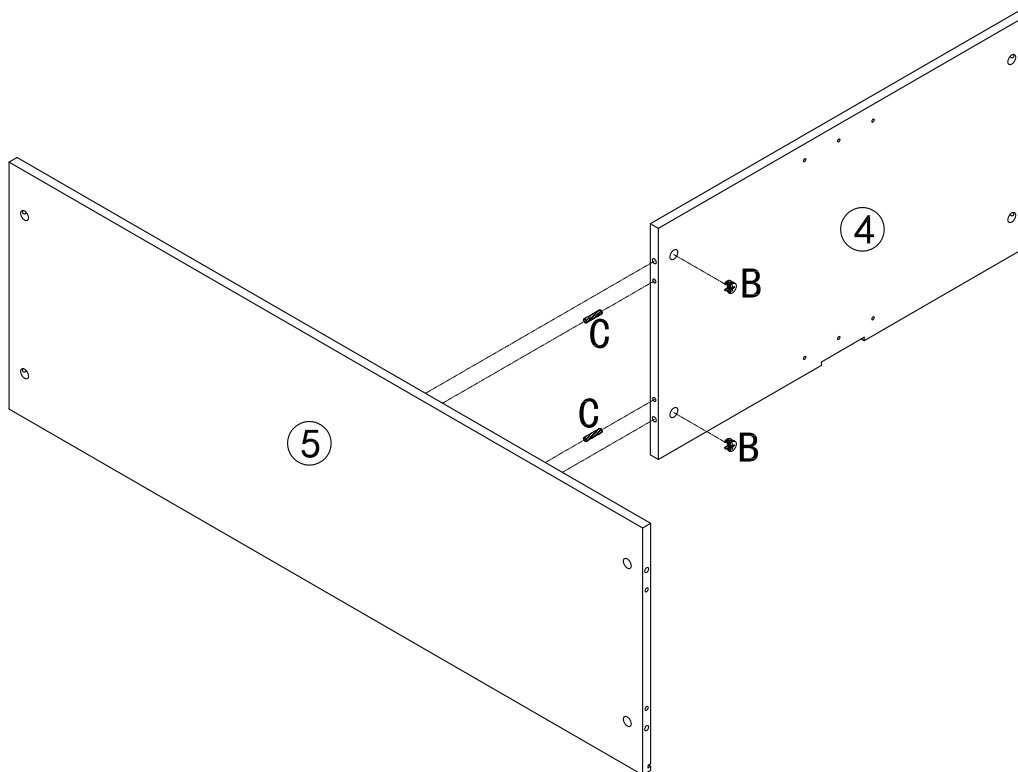

Step 3:

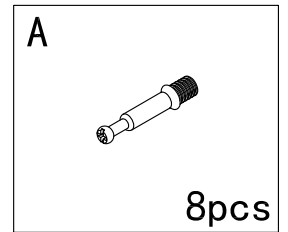
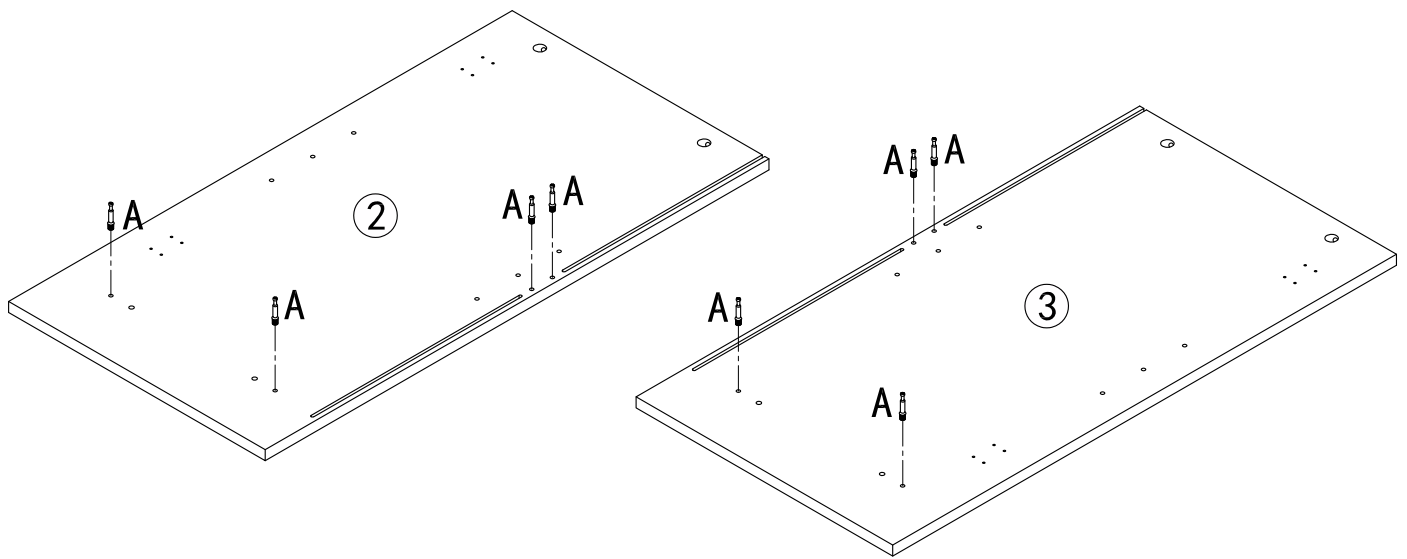

Step 4:

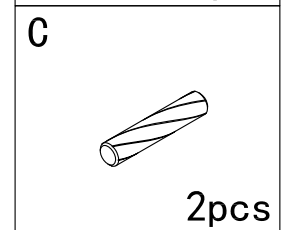
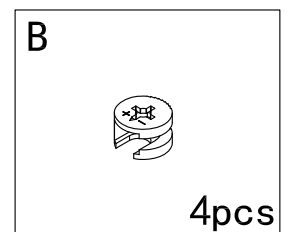
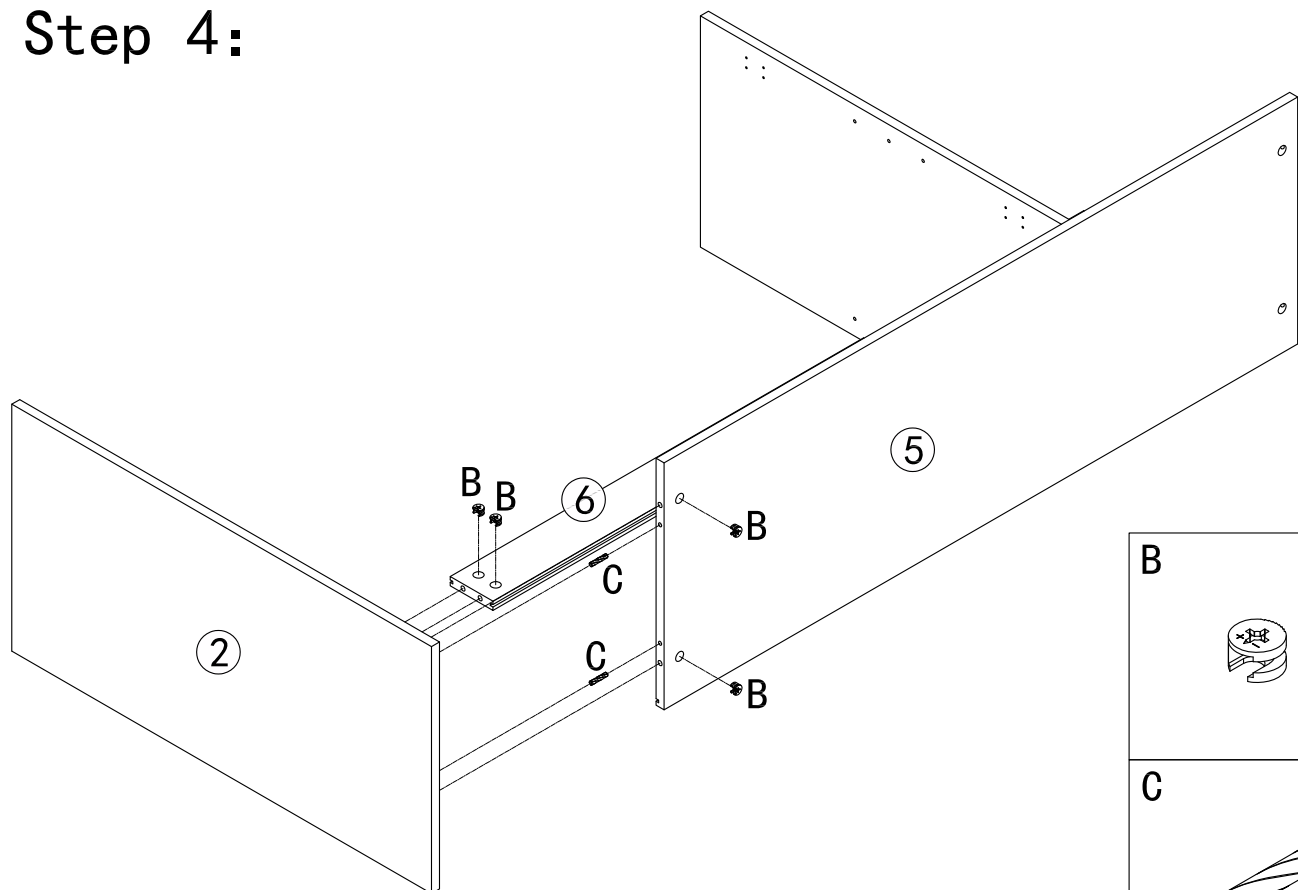

Step 5:

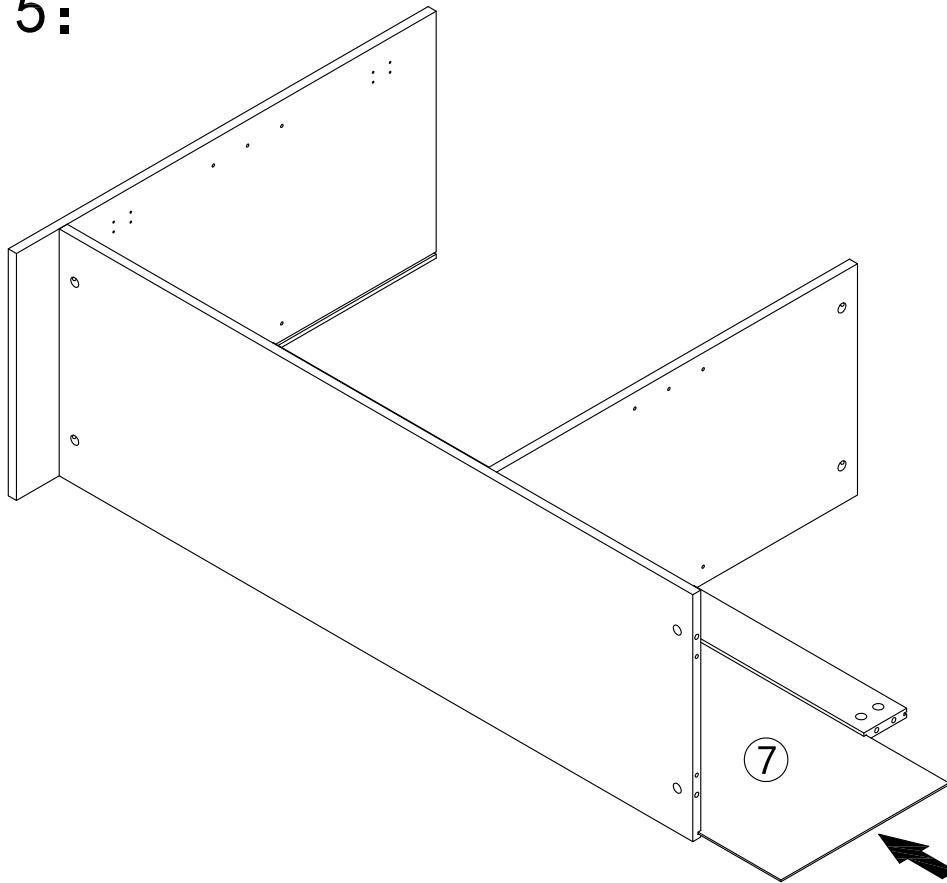

Step 6:

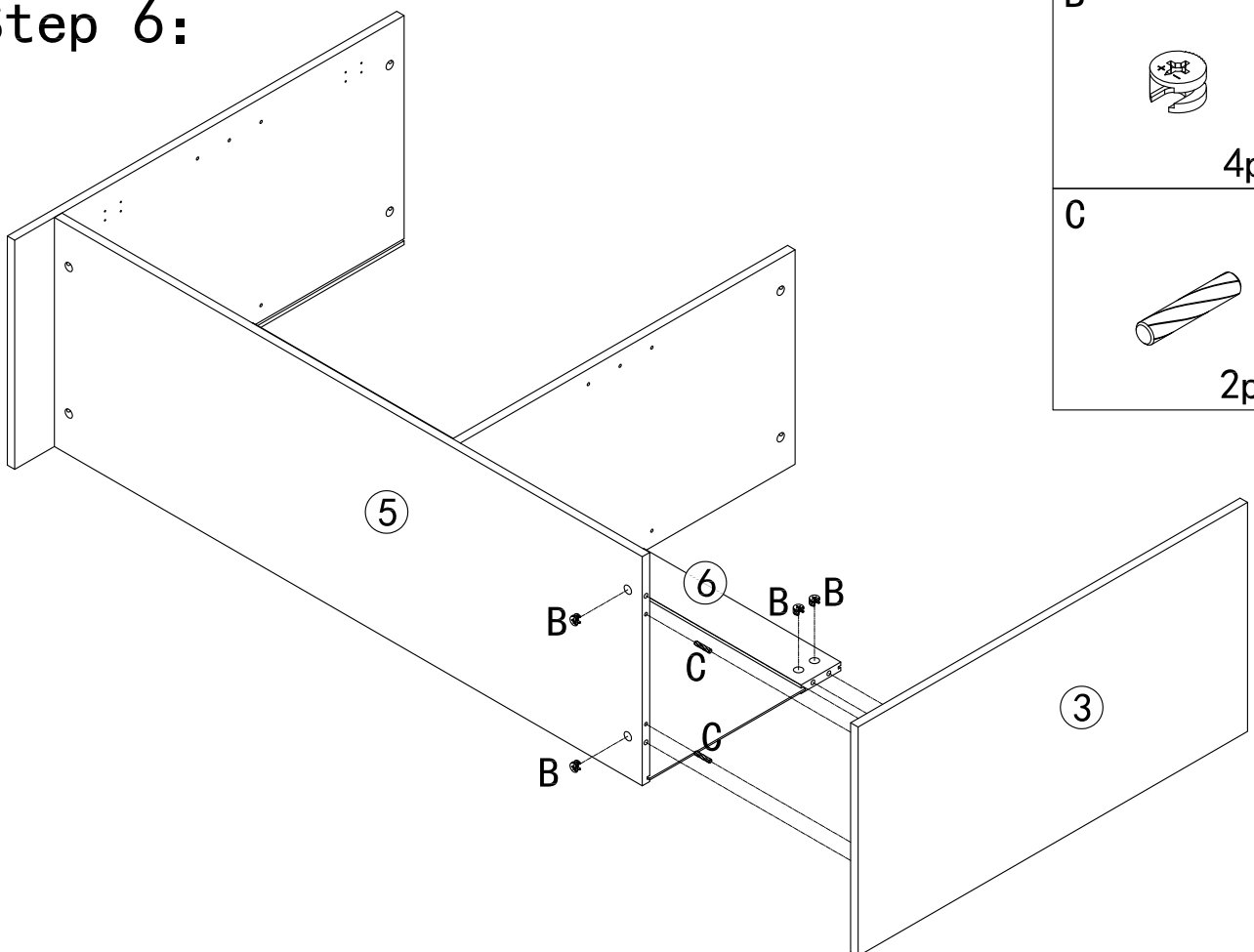

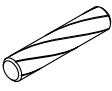

B		4pcs
C		2pcs

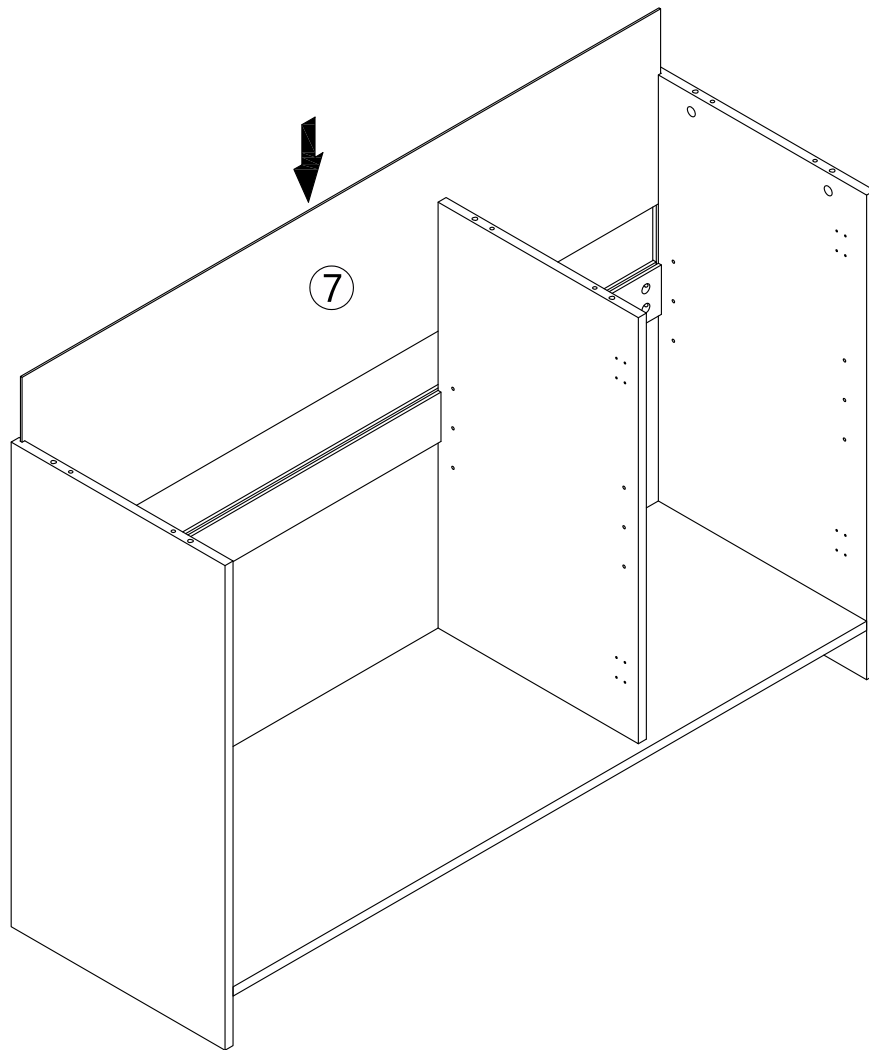
Step 7:



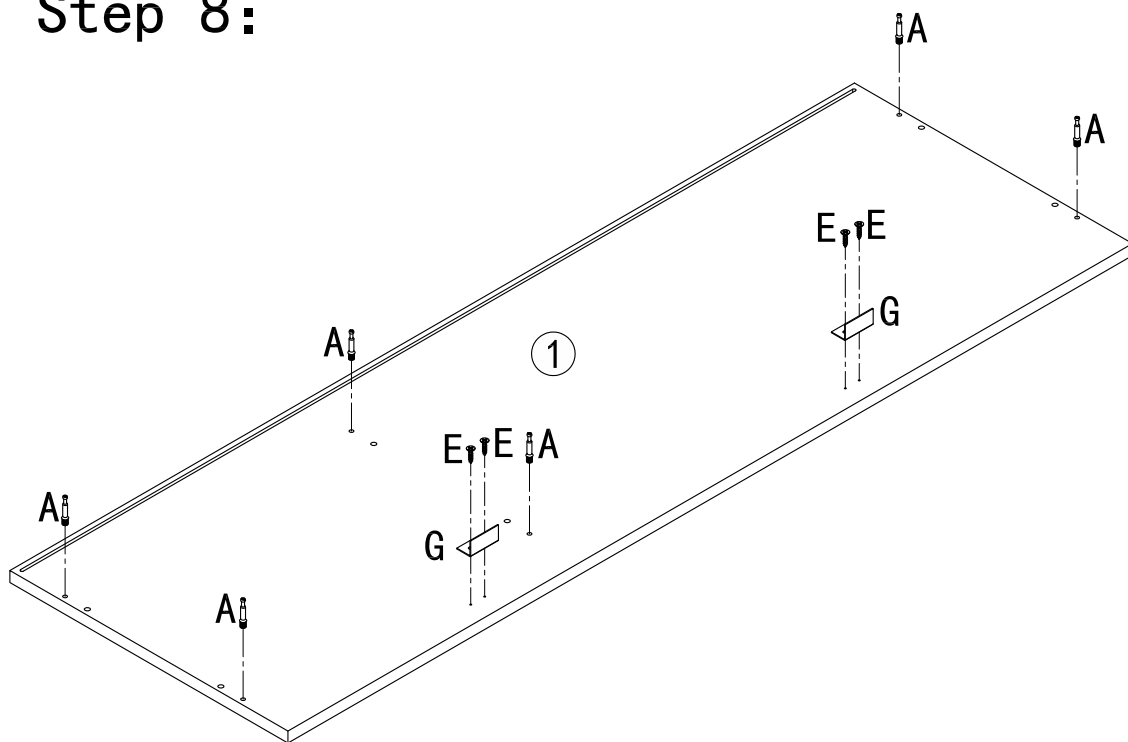

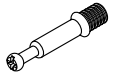
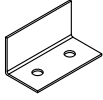
Step 8:



A		6pcs
G		2pcs
E		4pcs

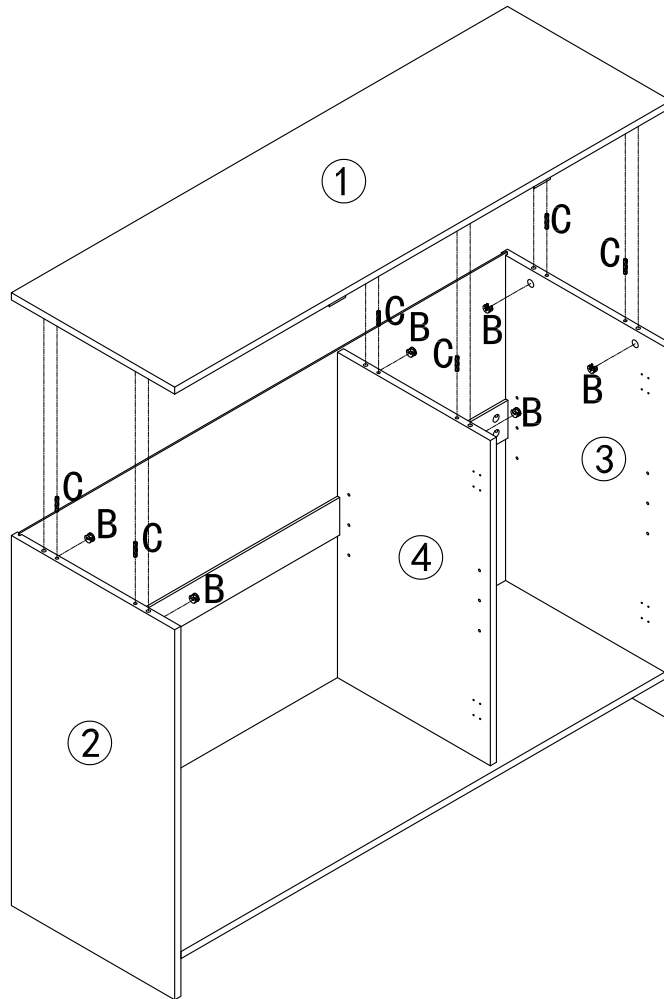

Step 9:

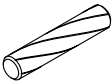

B		6pcs
C		6pcs

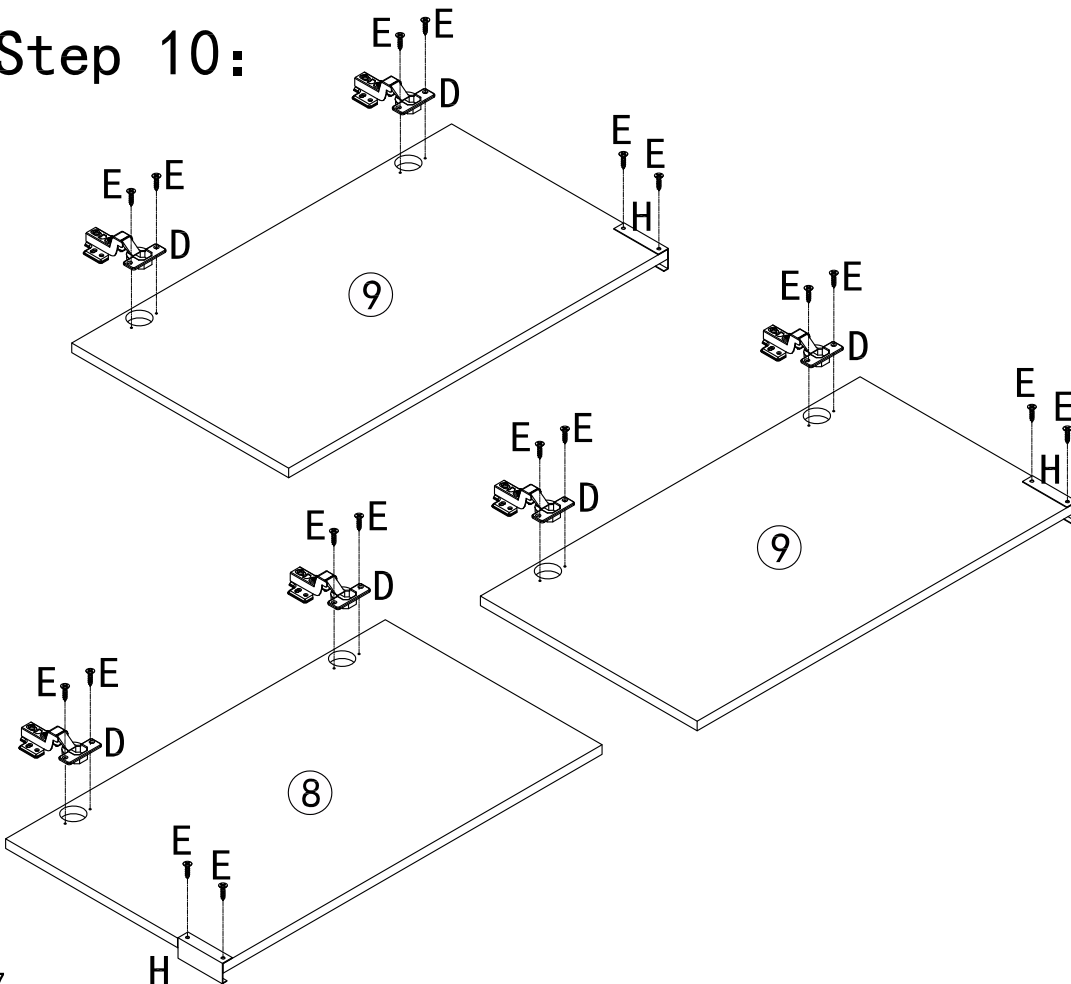
Step 10:

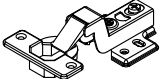

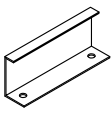
D		6pcs
E		18pcs
H		3pcs

Step 11:

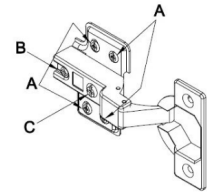
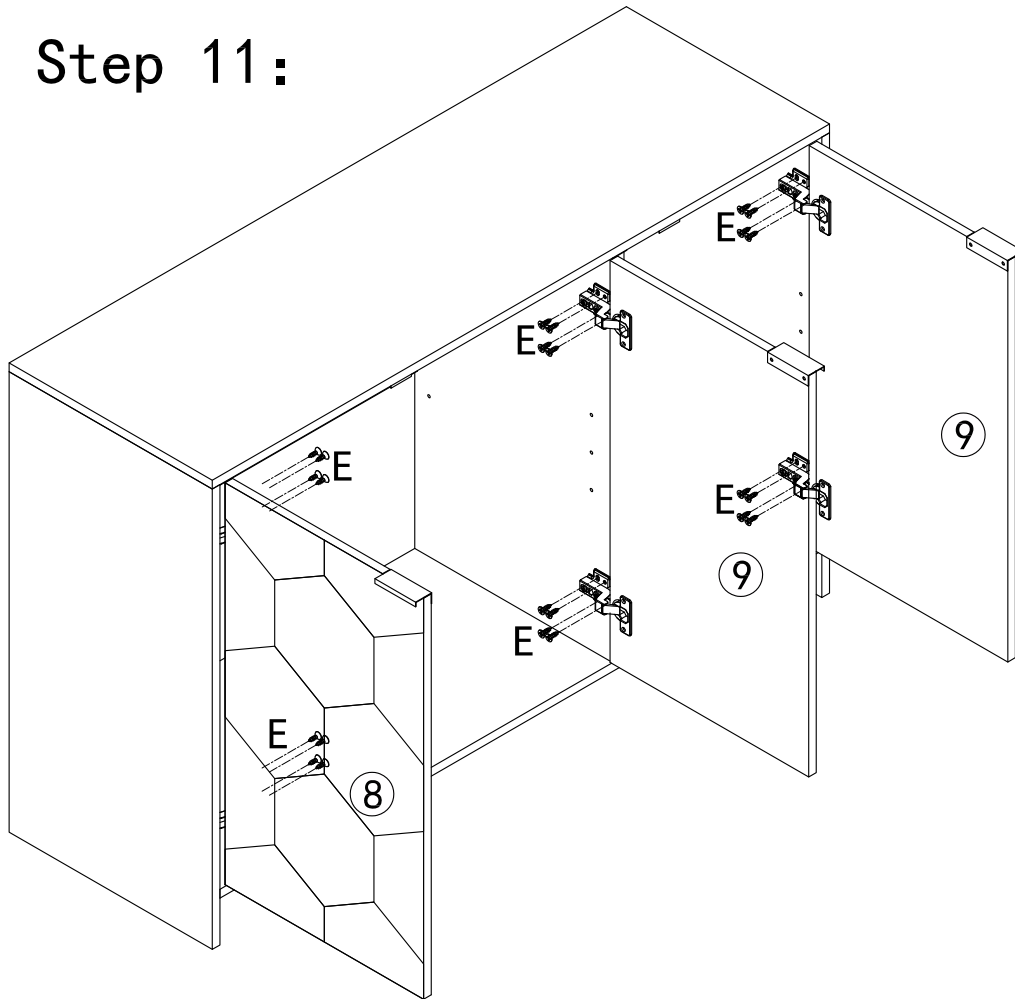

To adjust the vertical height.
Loosen the four screws "A" on both hinges. Two of them are usually in slotted holes which allows you to adjust up or down by a few mm. Then tighten back up.

To adjust depth.
Loosen screw "B" and adjust door, if the door can not be adjusted, please loosen screw "C", then try again. Tighten screw "B" and "C".

To adjust side ways.
Turning the screw "C" on BOTH hinges on each door.

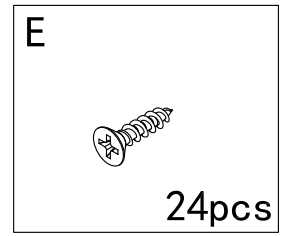

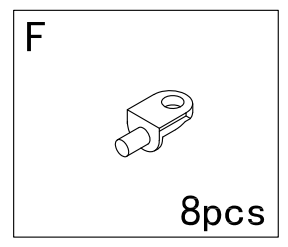
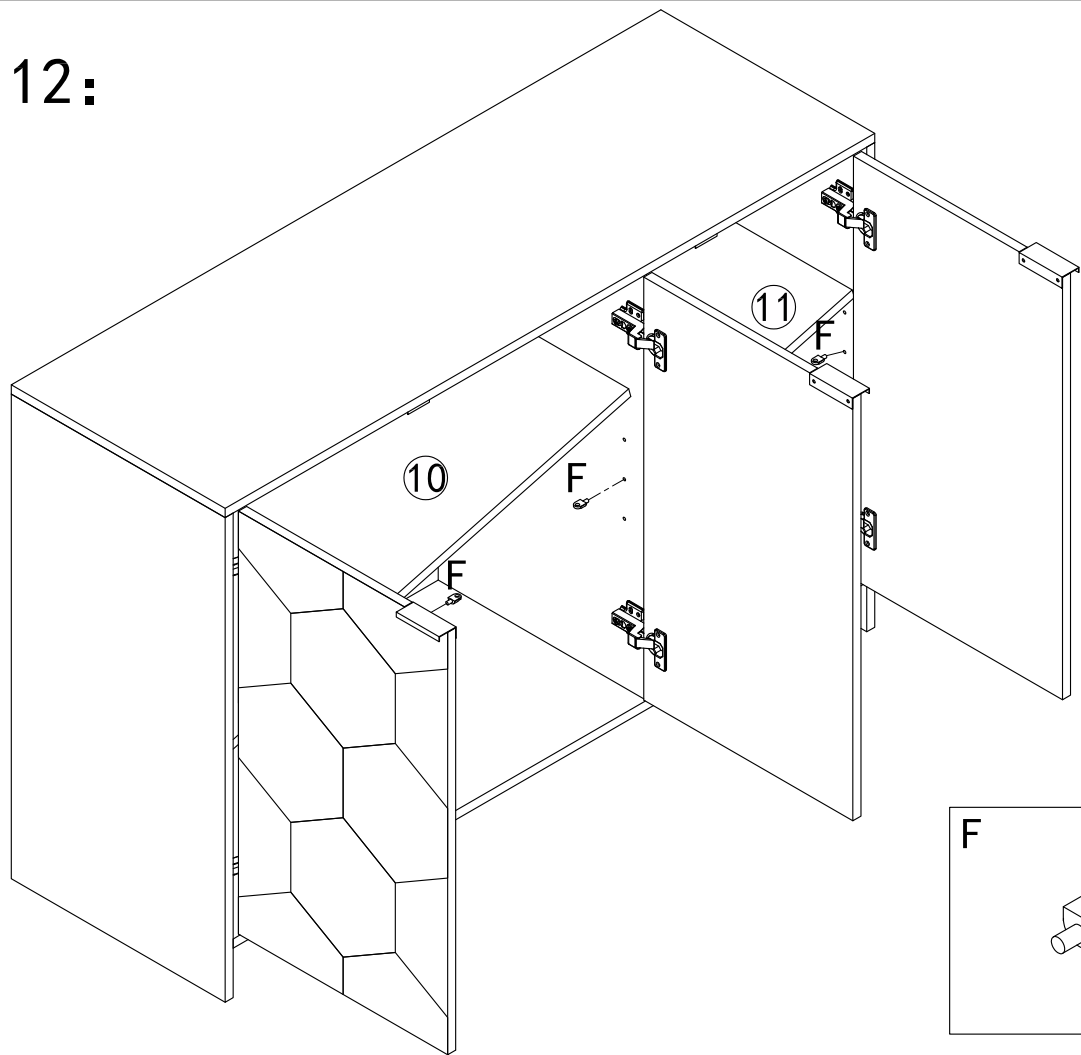

Step 12:



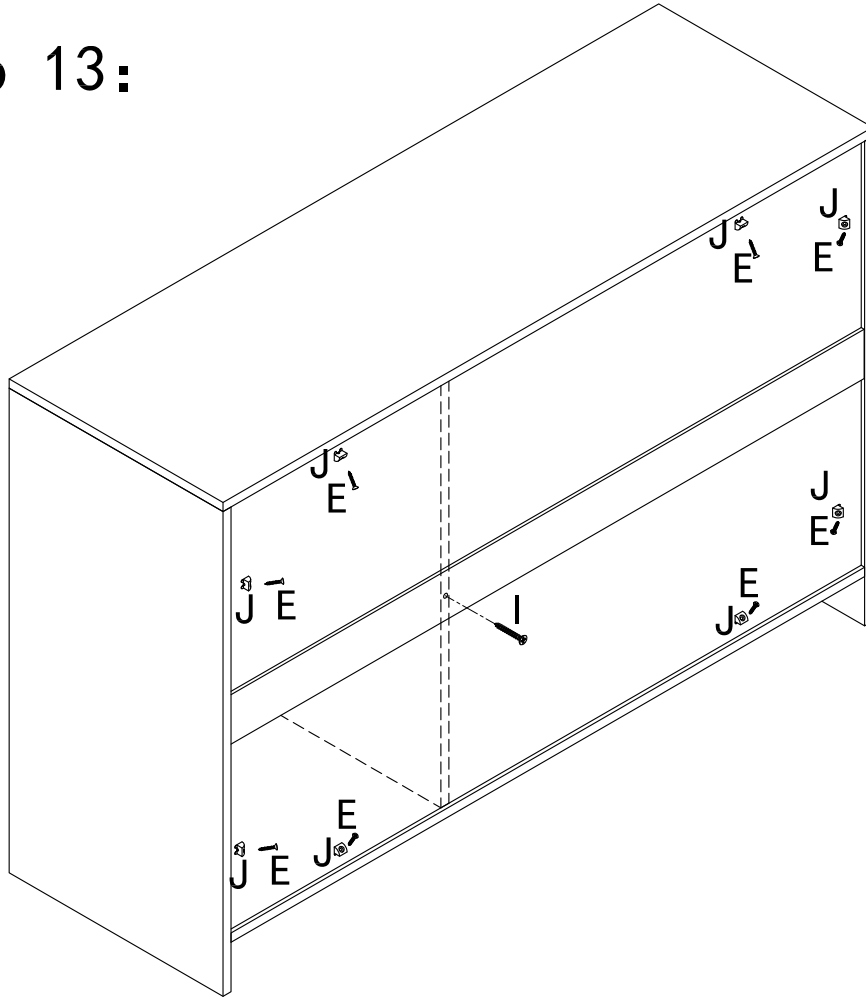

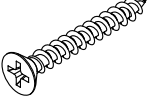

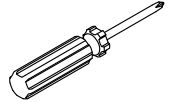
Step 13:

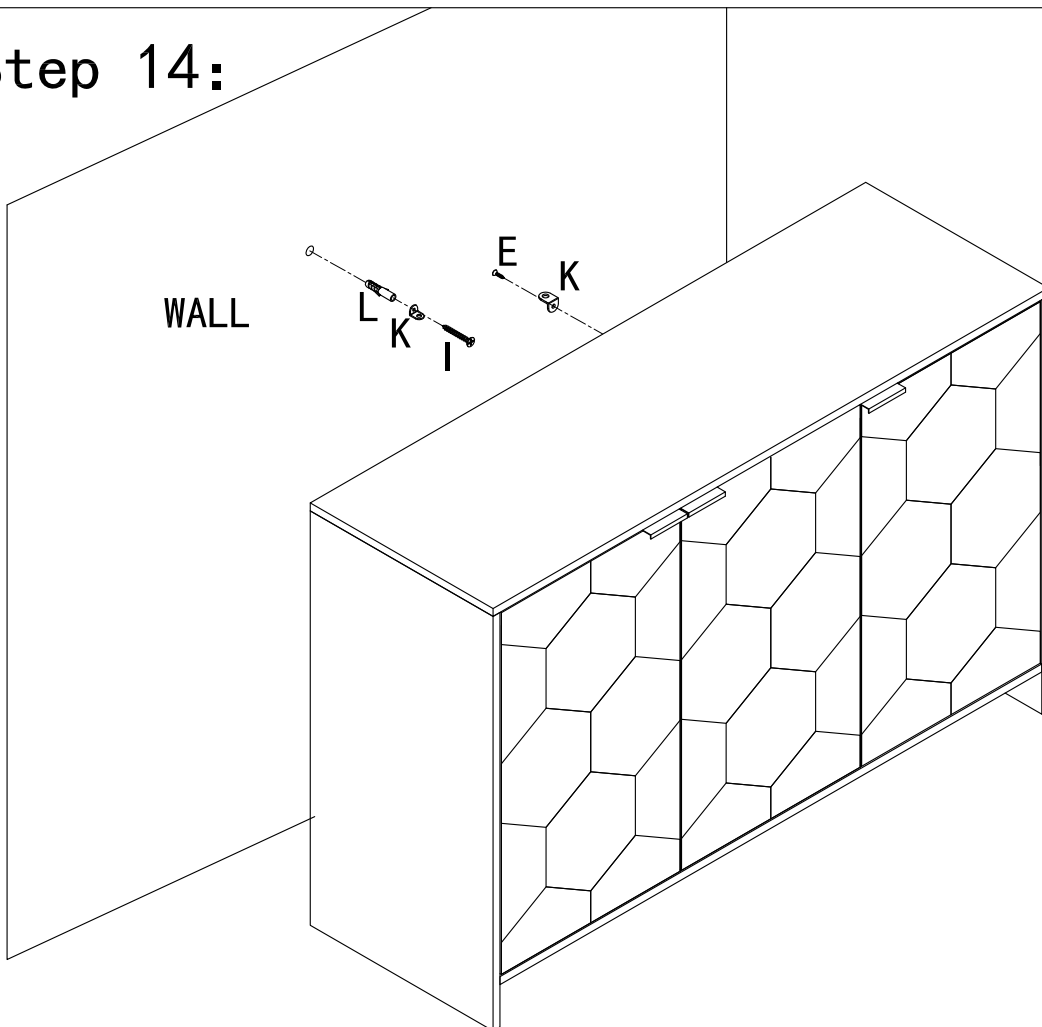

E		8pcs
I		1pc
J		8pcs
N		1pc

Step 14:

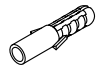
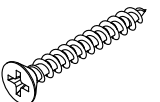

E		1pc
L		1pc
I		1pc
K		2pcs

Step 15:

