

Model: S003S

Assembly, Installation, Care, Maintenance and Use Instructions



- Warning -

- This swing set is for family domestic use only.
- This swing set is designed for use by children 3-8 years of age weighing no more than 100lbs
- This swing set is for outdoor use only.
- Children of all ages must be supervised by an adult at all times when using this swing set.
- Adult assembly of this swing set is required. Two adults are recommended for assembly.

WARNING

Please read this instruction manual before you start with the assembly or use this swing set. You must follow all safety instructions while using this equipment; Be absolutely sure that the surface, on which this swing set is set up on, is properly surfaced with fine sand, wood chips or double shredded bark mulch. Do not use this swing set on hard pack soil, concrete or any kind of hard surface. Read all cautionary statement before using this equipment.

OBSERVING THE FOLLOWING SAFETY PRECAUTIONS AND WARNINGS REDUCES THE LIKELIHOOD OF SERIOUS OR FATAL INJURY.

- Read this manual and follow all instructions before using and assembling your playground equipment.
- This playground equipment must be assembled and disassembled by an adult. It is recommended to have two adults assemble this playground equipment.
- Always provide on-site adult supervision for children of all ages at all times.
- This playground equipment is designed to be used by no more than 5 children between the ages of 3 to 8 years at any one time. Children should not weigh more than 100 lbs (45.45 Kg.) each.
- **WARNING:** Lawn swings (if applicable) are designed for use by children over two years of age. Use by children under the age of two can result in entrapment between the seat and back areas. **NEVER** place children in rear facing position or with legs between the seat and backrest because the child's body may pass through the opening causing entrapment of the child's head.
- Always ensure the playground equipment sits on level ground!
- To prevent serious injury to children, the playground equipment must not be used until properly assembled and anchored.
- Do anchor all playground equipment. Do not install over concrete, asphalt, gravel on any hard surface. A fall onto a hard surface can result in serious injury to the user.
- It is recommended that the playground equipment be placed in concrete. Be certain that all anchoring devices (including concrete) are placed below the level of the playing surface or below ground level to prevent tripping.
- Do not assemble or place playground equipment near any obstruction or sharp objects! Place playground equipment on level ground, not less than 6ft (1.8m) from any structures or obstacles such as fence, garage, shed house, overhanging branches, laundry line, electrical wires.
- Do not let children use the playground equipment until it is properly assembled and anchored.
- Provide proper surface material cover for this equipment prior to using this equipment. See page 4 of this manual for more information.
- If any bolts & nuts are missing, do not use this playground equipment!
- If the child has any physical condition that may affect his/her ability to use this equipment, one shall consult a physician, before allowing the child to use this equipment.
- Do not allow reckless playing, such as jumping off swing, slide, or glide ride.
- Do not allow more than one child to play on the swing, trapeze bar or slide at any one time. Children must take turns using the slide.
- Do not allow children over the weight limit to use this equipment. Adults should never ride on any of the swing seats, trapeze or slide.
- Dress children appropriately while on and around this equipment. (Do not allow children to wear ponchos, scarves, jewelry or any other loose fitting clothing that is potentially hazardous while using playground equipment).
- Instruct children not to use the equipment in any manner other than intended.

- Teach children to sit in the centre of the swing play items, with their full weight in the centre of the seats. Do not allow children to stand on the seats. One child per seat only! Do not allow children to lean to the side when riding on other rides, structural members or collide with other playmates.
- Instruct children not to walk too closely in front of, behind, or between moving items.
- Instruct children to keep a safe distance away to avoid being struck by items in play.
- Instruct children not to twist swing chains or ropes or loop them over the top support bar since this may reduce the strength of the chain or rope and may result in failure.
- Instruct children to avoid swinging empty play items. These may strike other children or come back and strike you.
- Instruct children not to get off equipment while it is in motion. Do not allow children to jump from moving play items.
- Do not allow children to swing play items more than 60 degrees.
- Do not allow children to climb or play on equipment when equipment is wet. Slip or falls may occur.
- Check the openings between rollers and sliding surfaces of roller slides for foreign materials that could be potentially hazardous to users.
- Verify that suspended climbing ropes, chain, or cable are secured at both ends, and verify that suspended climbing ropes, chain, or cable cannot be looped back on itself.
- Instruct children not to attach items to the playground equipment that are not specifically designed for use with the equipment such as but not limited to jump ropes, clothesline, pet leashes, cables and chain as they

may cause a strangulation hazard.

- Instruct children not to go down slide head first.
- Check slide bed for extreme heat before letting children use slide (When exposed to direct sunlight)
- Do not allow children to climb on swing from structural members (Legs, top bar and chin bar). These are structural components only and NOT play features.
- Do ensure that all nuts and bolts are completely tightened after assembling the playground equipment.
- Dispose of all packaging properly after unit has been assembled.
- Please retain the instruction manual for future reference and review each season.

CARE & MAINTENANCE INSTRUCTION

It is important to perform the following maintenance inspections at the beginning of each season and twice monthly thereafter.

- * Inspect all nuts and bolts for tightness and tighten as required. It is particularly important that this procedure be followed at the beginning of each season.
- * Remove plastic swing seats slide and take indoors or do not use when temperature drops below 32°F (0° C).
- * Inspect swing seats, ropes, cables and chains for evidence of deterioration. Replace as needed.
- * Inspect all coverings for bolts and sharp edges to be certain they are in place. Replace when necessary.
- * Oil all metallic moving parts monthly during the usage period.
- * Inspect metal tubing and slide bed for damage and sharp edges. Replace when necessary.
- * Sand rusted areas on metal tubing and repaint using a nonlead-based paint meeting the requirements of Title 16 CFR Part 1303.
- * If slide bed is exposed to direct sunlight, always check bed to ensure it is not too hot for children use. Pour cold water onto the slide bed until it cools. Inspect slide bed periodically during use. Replace when necessary.
- * Plastic components should be replaced every three years.

DISPOSAL INSTRUCTIONS

- * When it is time to dispose of the playground equipment, please use care when disassembling the playground equipment. Dispose in a safe place and manner so as not to present any hazards to any individual. Wear heavy duty working gloves!
- * Be sure to completely disassemble the whole swing and slide sets, before disposal.
- * Do not leave partially disassembled equipment in area where accessible by children.
- * Consumer may wish to recycle the steel tubing, please take the frame to your local recycling centre.
- * All plastic part could be recycled, take it to your local recycling centre.
- * Do not let children play with any disassembled parts destined for disposal, such as chain, slide, tubings, bolts, nuts, screws!!

IMPORTANT CONSUMER INFORMATION SHEET

The Consumer Product Safety Commission estimates that about 200,000 injuries occurred from falls from playground equipment; which requires hospital emergency treatment. Injuries from falling tend to be the most serious of all playground injury, and it may be potentially fatal; especially when it is a head injury. The ground surface under the playground equipment can be an important factor in determining the injury causing potential of a fall. A fall onto a shock absorbing surface is less likely to cause serious injury in comparison to a fall onto a non shock absorbing hard surface. Never place playground equipment on hard surface such as concrete, asphalt, rocks, grass may appear to be acceptable, but in heavy traffic area, it may quickly turn into hard packed earth. Fine sand, wood chips, shredded bark are acceptable shock absorbing surface, when installed at a sufficient depth under the playground equipment, it must be maintained properly under and around the perimeter of playground equipment.

Table below lists the maximum height from which a child would not be expected to sustain a life-threatening injury to the head, when falling onto the loose fill surface materials, provided that these materials are installed and maintained at 6, 9 and 12 inches deep. However, consumers should recognize that no matter what type of surface material is used, it can not prevent all injuries due to falls.

**FALL HEIGHT IN FEET FROM WHICH
A LIFE THREATENING HEAD INJURY WOULD NOT BE EXPECTED**

MATERIAL	6INCH DEPTH	9INCH DEPTH	12INCH DEPTH
Double shredded bark mulch	6	10	11
Wood Chips	6	7	12
Fine Sand	5	5	9

We recommend that surfacing material as per table above should extend a minimum of 6ft in all direction from the perimeter of the playground equipment. In certain cases, a child may deliberately jump from a moving swing. Therefore, any shock absorbing material should extend in the front and rear of swing a minimum of 2 times the height of the pivot point; this height is determined by measuring from a point directly beneath the pivot on the supporting structure.

Please note this information is intended to assist in comparing the relative shock-absorbing properties of various materials. No particular material is recommended over another. Every material is only effective when properly maintained. Material should be maintained and replenished periodically after inspection by user, to maintain the correct depth necessary for your equipment.

Note: The maximum fall height for this product is 6 feet. The minimum ground clearance between the bottom of the suspended plays and the playing or ground service must be 8 inches.

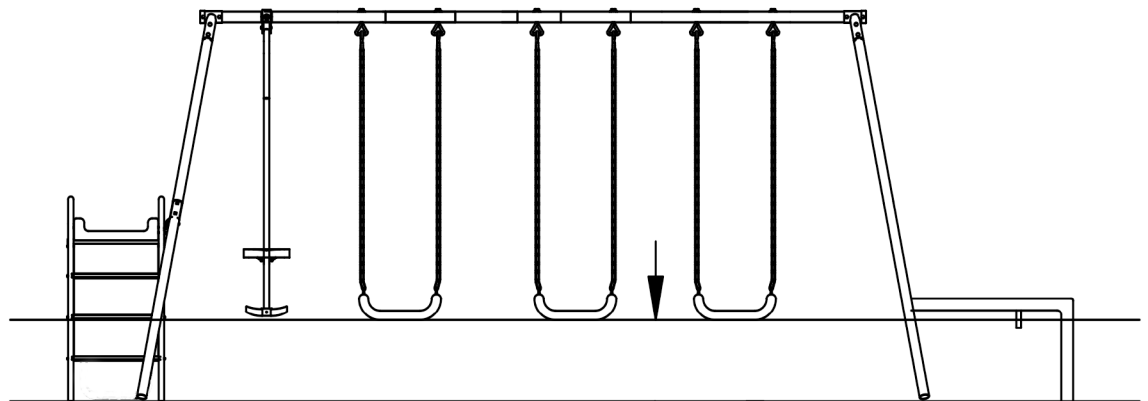

YOU MUST MAINTAIN A MINIMUM OF 8 INCHES OF GROUND CLEARANCE

PARTS LIST

Please prepare the following tools prior to assembling this equipment: A socket set or open ended spanner may aid in assembly(not supplied)

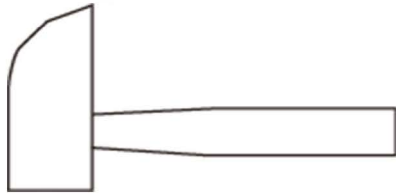

Hammer
(If you intend to install
Anchor,this is needed.)

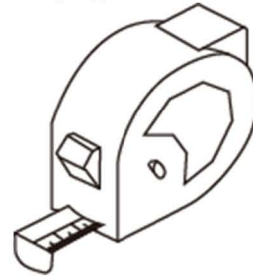

Tape Measure
Not included

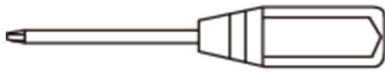

Flat Head and Philips
Head Screwdriver
Not included



Wrench
(included)

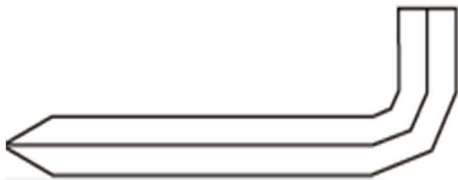

Allen Wrench
(included)





Parts list for main frame

A1		LEFT TOP BAR	1 PCS
A2		LONG TOP BAR	1 PCS
A3		TOP SECTION LEG	4 PCS
A5		BOTTOM SECTION LEG	4 PCS
A6		CROSS BAR	2 PCS



Hardware used for main frame assembly

B1		BOLT 5/16*63	14 PCS
B2		BOLT 5/16"*63	4 PCS
B3		NYLON NUT 5/16"	18 PCS
B4		PLASTIC CAP	18 PCS
B5		ARC WASHER	32 PCS
B6		SPRING WASHER	4 PCS

Parts list for swing seat





J1		PVC COVERED CHAIN(PREASSEMBLED)	4 PCS
J3		EYE BOLT WITH ATTACHMENT BOLT(PREASSEMBLED)	4 PCS
J4		EYE BOLT(PREASSEMBLED)	4 PCS
K1		SWTNG SEAT	2 PCS

Hardware used for swing seat assembly



J6		NYLON NUT 5/16"	8 PCS
J8		ARC WASHER	8 PCS
J9		PLASTIC CAP	8 PCS

Parts list for glide ride







L1		SECTION HANGER	2PCS
L2		GLIDE SEAT SUPPORT	2 PCS

M1		TUBE CAP(PREASSEMBLED)	2 PCS
M2		SMALL NYLON BEARIND (PREASSEMBLED)	2 PCS
M3		LARGE NYLON BEARING	4 PCS
M4		GLIDE SEAT	2 PCS
M5		FOOTREST	2 PCS

Bracket used for glide ride assembly

L4		BRACKET	1 PCS
L5		BRACKET CLAMP	1 PCS
L6		WASHER	4 PCS
N3		BOLT 5/16''*25	2 PCS
N8		NYLON NUT 5/16''	2 PCS
N14		PLASTIC CAP	2 PCS

Hardware used for glide ride assembly

N1		BOLT 1/4''*35	4 PCS
N2		BOLT 1/4''*45	2 PCS
N5		SCREW V6 ϕ 5*15	4 PCS
N6		J-BOLT	2 PCS
N7		SPRING WASHER	8 PCS
N9		WASHER	12 PCS
N11		NUT 1/4''	8 PCS

ASSEMBLY INSTRUCTION

- ❖ Place the playground equipment on level ground, not less than 6 ft (1.8 m) from any structure or obstruction such as a fence, garage, house, overhanging branches, laundry lines, or electrical wires.
- ❖ Do not install the playground equipment over concrete, asphalt, packed earth, or any other hard surface. A fall onto a hard surface can result in serious injury to the user.

TIGHTENING NUTS & BOLTS





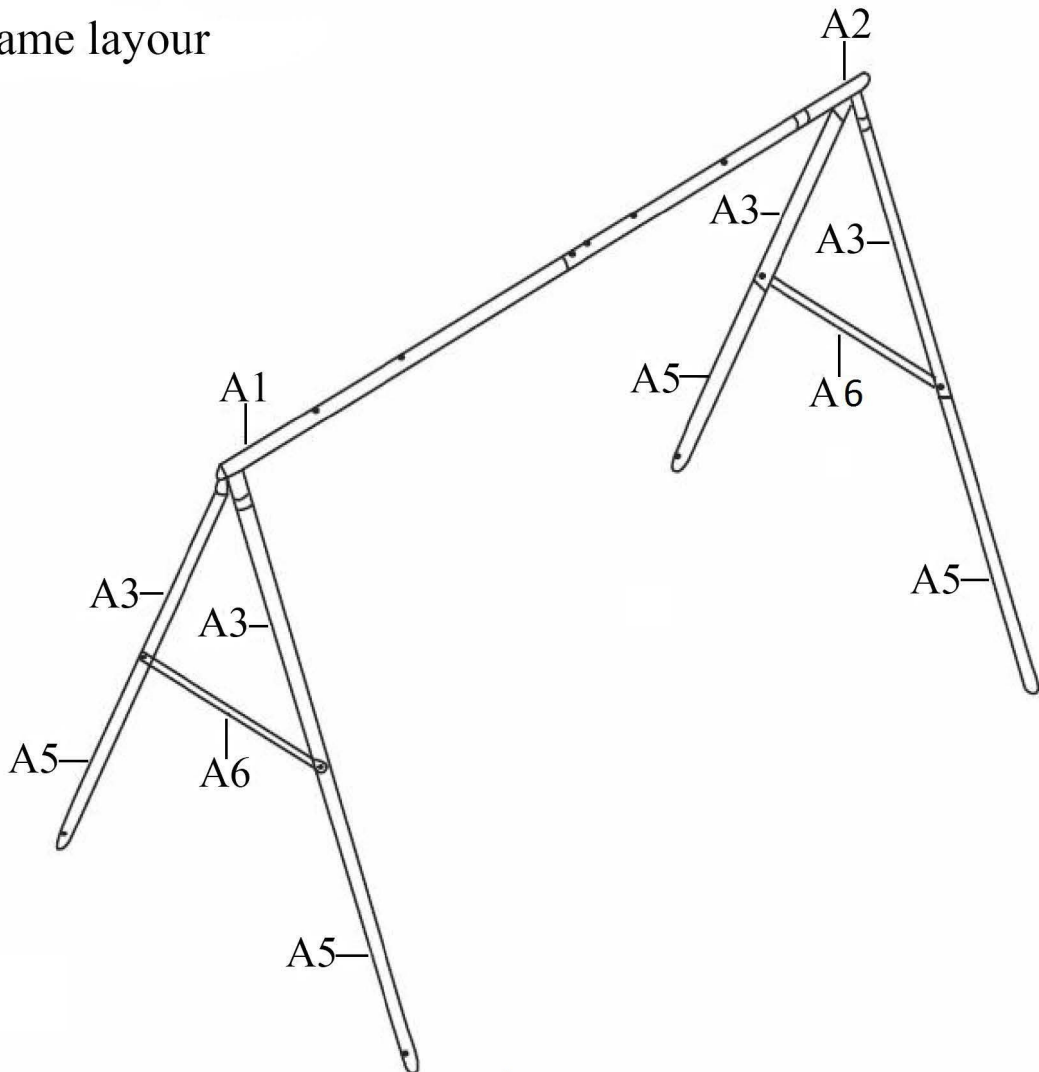

- * Do not over-tighten the nuts and bolts when you are assembling your playground equipment. This will allow for some possible adjustments and ease of installation.
- * Once you have finished the assembly of the playground assembly, go back over all of the nuts and bolts and properly tighten all of them before using the playground equipment.

Main frame layour



Step 1





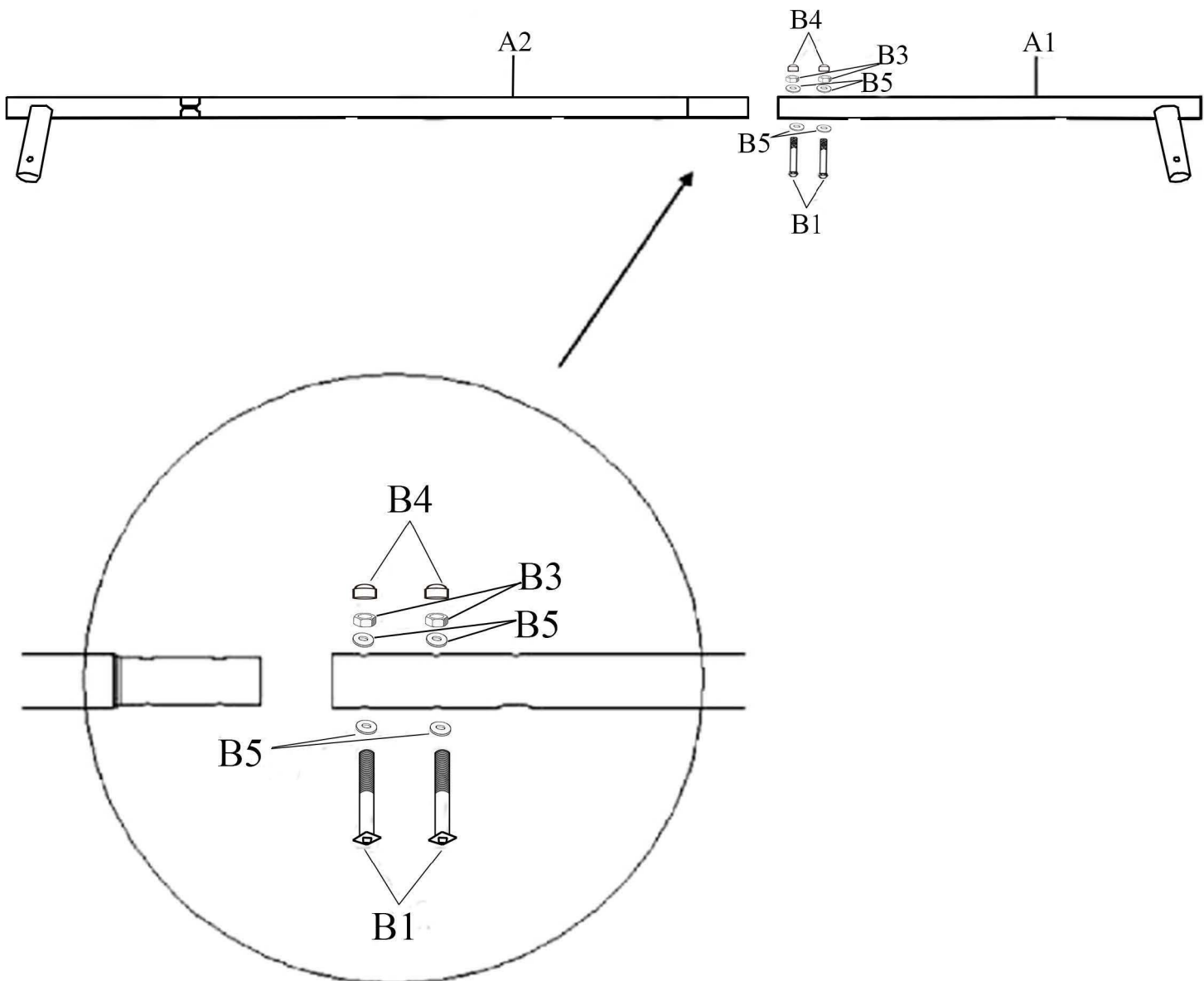

- Insert A1 into the other end of A2, secure with B1, B5, B3 and B4
- HINT: Please make sure that concave hole faces down.

 Wrench(included)	B1  BOLT 5/16"63 QTY:2	B3  NYLON NUT 5/16" QTY:2
 Allen Wrench (included)	B4  PLASTIC CAP QTY:2	B5  ARC WASHER QTY:4

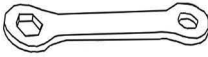

Step 2





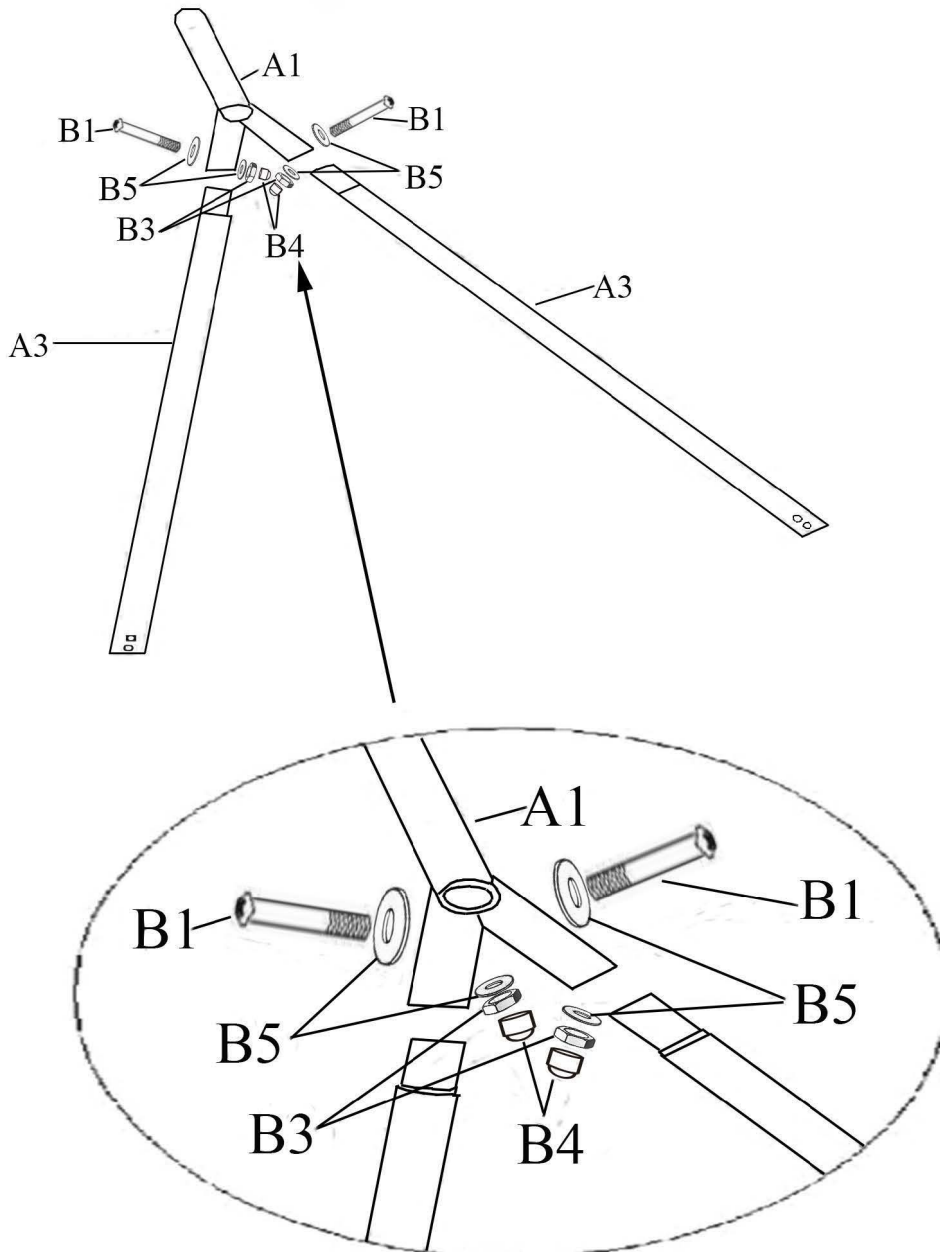

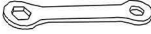

- Insert small end of A3 into the socket at the end of A1. align holes on them.
- Secure with B1, B5, B3 and B4.
- Then attach the other two pieces of on the other side to A2 the same.

 Wrench (included)	B1  BOLT 5/16"63 QTY:4	B3  NYLON NUT 5/16" QTY:4
 Allen Wrench (included)	B4  PLASTIC CAP QTY:4	B5  ARC WASHER QTY:8

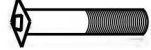

Step 3

- Insert small end of A3 into the socket at the end of A5. align holes on them.
- Secure with B1,B5,B3,and B4.
- Attach A6 to A5,Secure with B2,B6,B5,B3,and B4
- Repeat above to.assemble the other A3 to A5 that is attached to the end of A2.



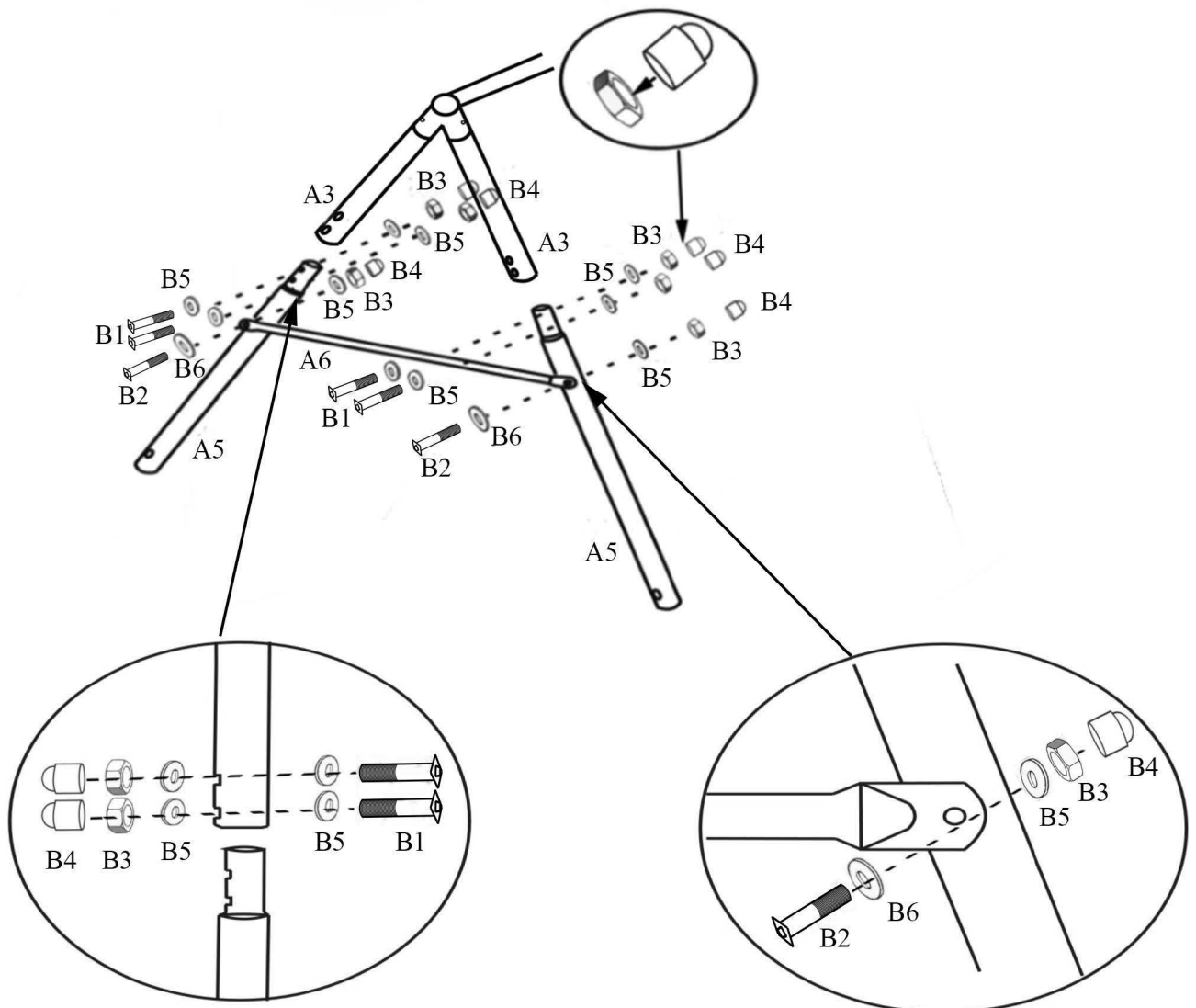

 Wrench (included)	B1  BOLT 5/16*63 QTY:8	B2  BOLT 5/16*63 QTY:4	B3  NYLON NUT 5/16" QTY:12
 Allen Wrench (included)	B4  PLASTIC CAP QTY:12	B5  ARC WASHER QTY:20	B6  SPRING WASHER QTY:4

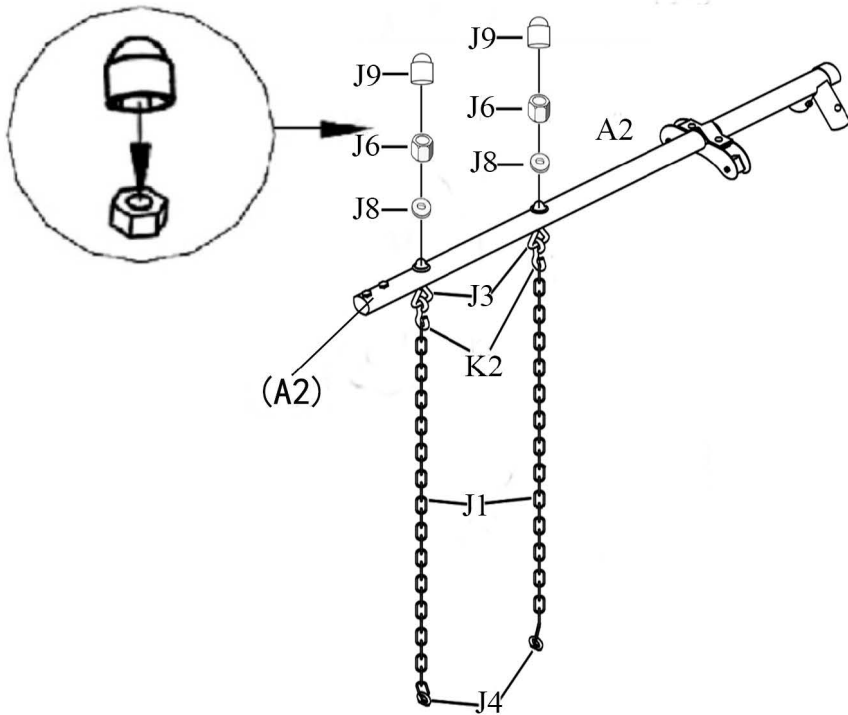

Step 4

- Insert J3 into holes on A1, A2.
- Secure it with J8, J9, and J6





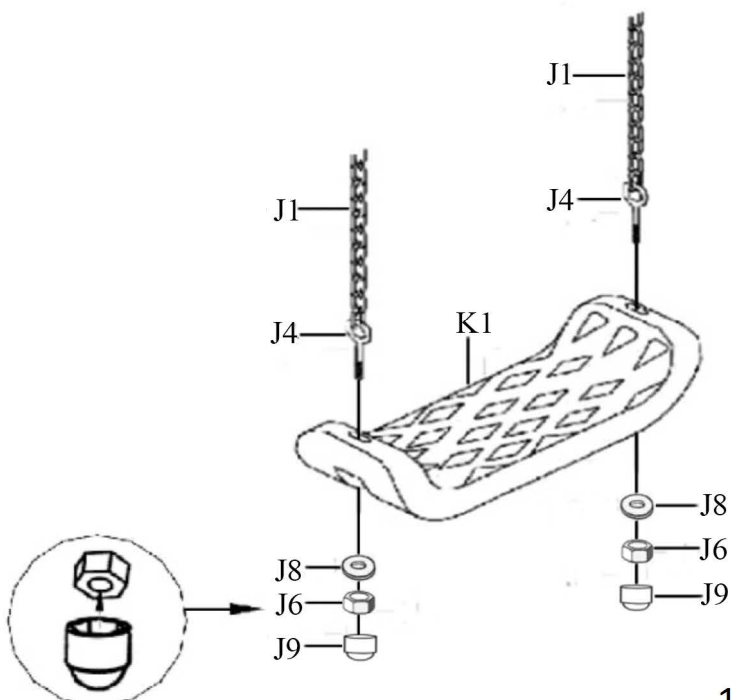

J6  NYLON NUT M8 QTY:4	J8  ARC WASHER QTY:4
J9  PLASTIC CAP QTY:4	 WRENCH(INCLUDED) QTY:1

Step 5

- J4 and K1 are PRE-ASSEMBLED,if you find loosely,please follow below step
- Attach K1 to J4.
- Secure with J8,J9 and J6.



J6  NYLON NUT M8 QTY:4	J8  ARC WASHER QTY:4
J9  PLASTIC CAP QTY:4	 WRENCH(INCLUDED) QTY:1

Step 6

- Attach L5,L4 and L6 to A2 as Shown.
- Use special socket wrench and screw-driver to tighten the N3 and N8.

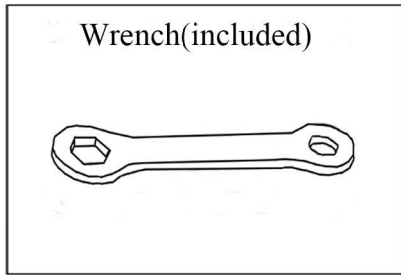

N3		N8	
	BOLT 5/16"*25 QTY:2		NYLON NUT 5/16" QTY:2
N14		L6	
	PLASTIC CAP QTY:2		WASHER QTY:4

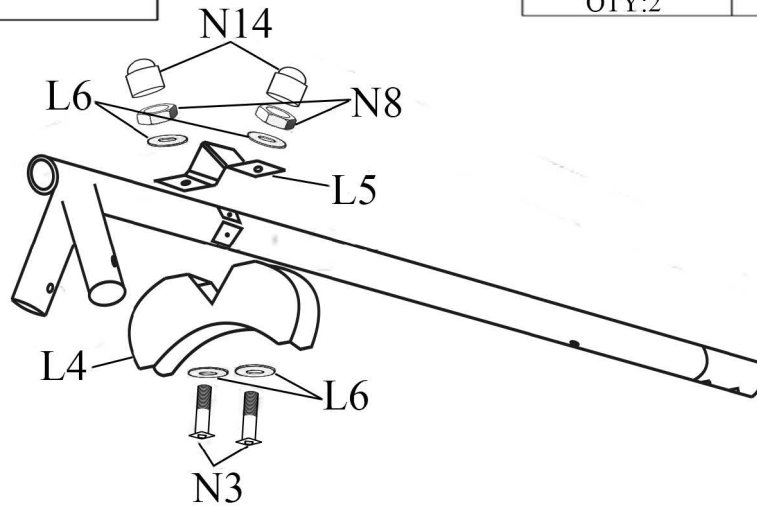

Step 7

- Attach M5 to L1.
- Secure N5,N9.
- M1,M2 and L1 are PRE-ASSEMBLED,if you find it loosely,please follow step.
- Attach M1 to the top of L1,and then align holes on M1 and L1,then insert M2 as shown.
- Hold M2 after inserting it into holes of M1.

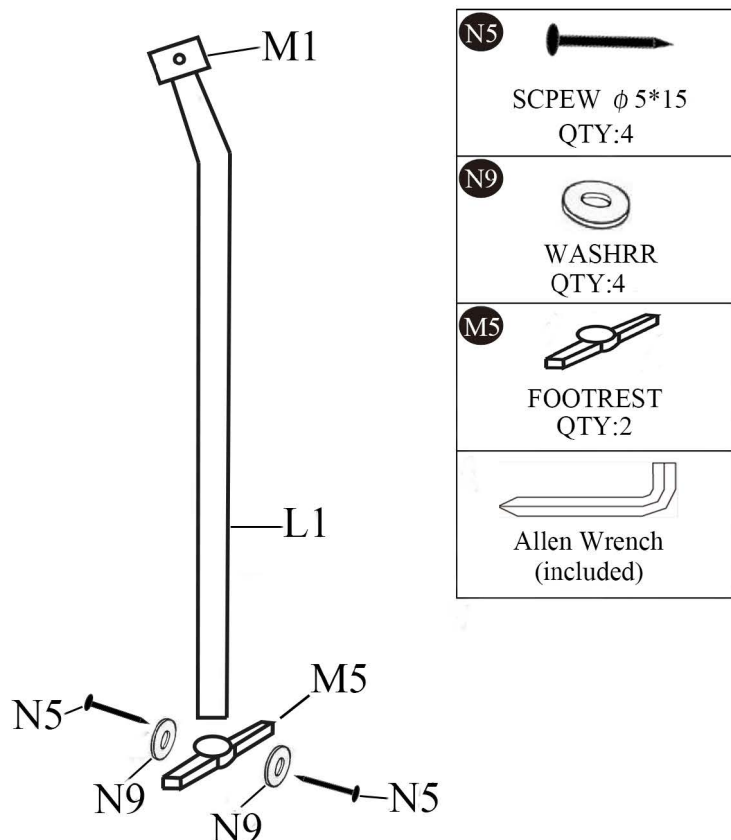

N5	
	SCPEW ϕ 5*15 QTY:4
N9	
	WASHRR QTY:4
M5	
	FOOTREST QTY:2
	Allen Wrench (included)

Step 8

- Attach L1 to L5, secure with N2, N7, N9 and N11.

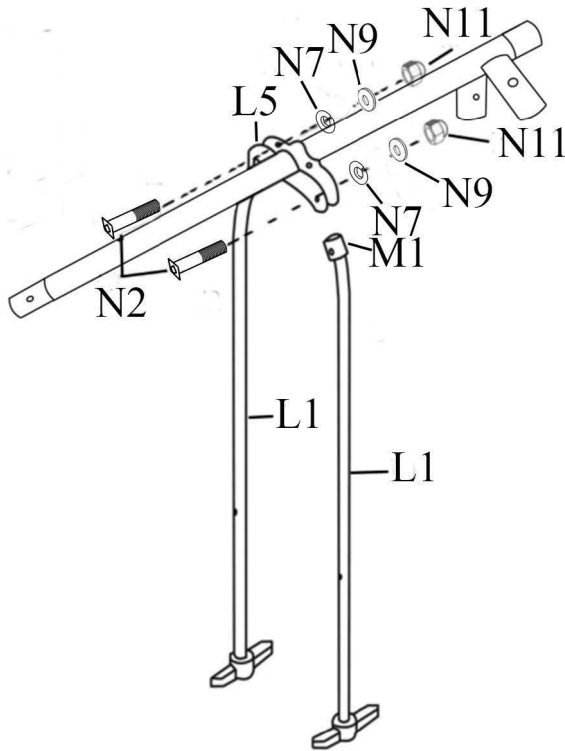
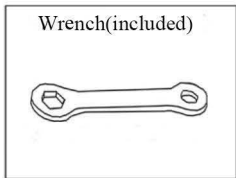

N2		N7	
	BOLT 1/4"*45 QTY:2		SPRING WASHER QTY:2
N11		N9	
	NUT 1/4" QTY:2		WASHER QTY:2

Step 9



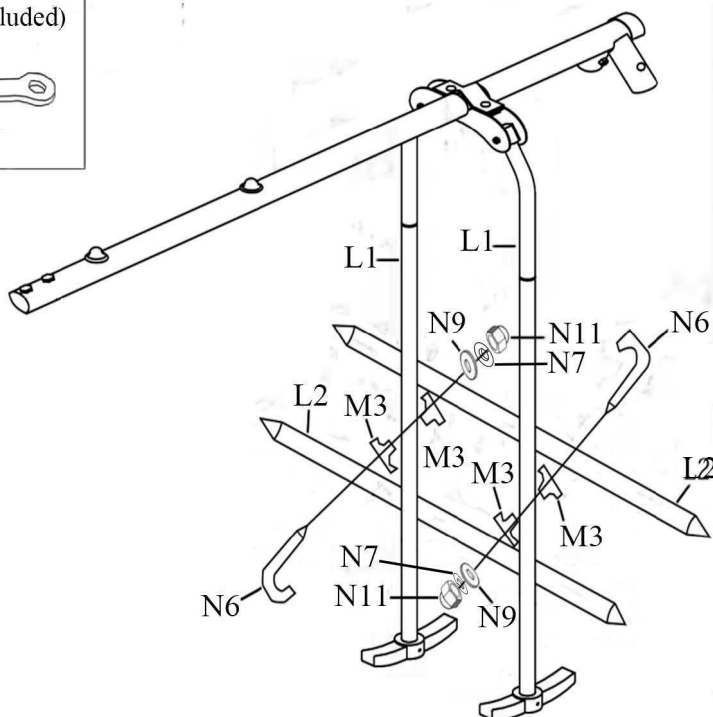
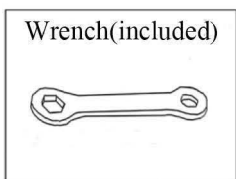

- Insert 2xM3 into L1, then attach L2 to L1 with N6, lightly secure N6, N9, N7 and N11, Do not tighten completely
- Attach the other L1, L2 and L3 by the as way as described above, once this is done, go back and securely tighten all N9



N9		N7	
	WASHER QTY:2		SPRING WASHER
N11		N6	
	NUT 1/4" QTY:2		J-BOLT QTY:2
M3			
	LARGE NYLON BEARING QTY:4		

Step 10

- Attach M4 to L2 with N1
- Secure with N1,N9,N7,and N11

 Wrench (included)	 BOLT 1/4"*35 QTY:4	 SPRING WASHER QTY:4
	 WASHER QTY:4	 NUT 1/4" QTY:4

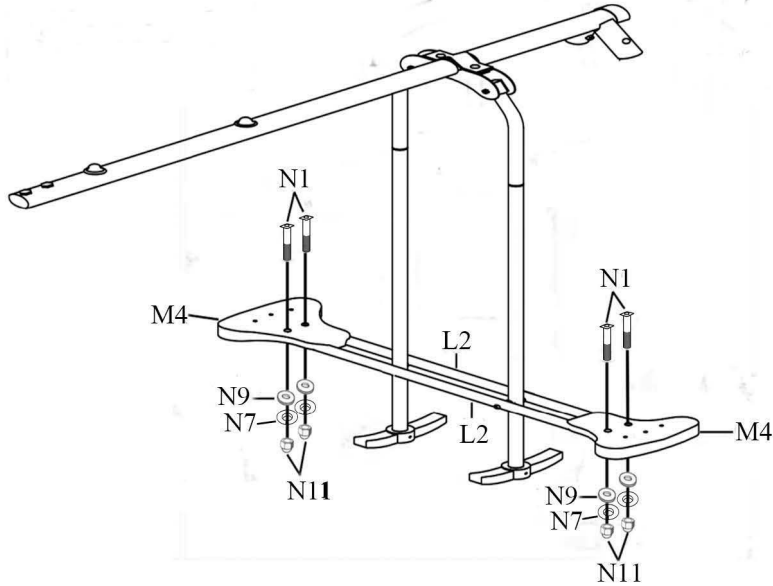

You have finished assembling your playground equipment.

Now go back and securely tighten all bolts and nuts before using the playground equipment.

- ✧ NOTE: Make sure to go back to check all hardware and securely tighten all bolts and nuts before using the playground equipment.
- ✧ ! WARNING: Do not let children use the playground equipment until it is properly assembled and anchored.
- ✧ Optional anchors
- ✧ (Note: anchors are not included)
- ✧ By anchoring your set with Ground Anchors, you will be able to move your gym set at a future date. Either method is suitable for hard soil (clay, etc.) If your soil is soft (sand, etc.), the corkscrew method is recommended. If you wish to permanently secure your gym set, either type of anchor may be set in concrete. Ensure equipment is firmly anchored (cementing is usually recommended). When equipment is cemented; do not bury the legs more than three inches below the ground surface. This will ensure sufficient space remains under the swinging plays. Be certain that all anchoring devices (including concrete) are placed below the level of the playing surface or below ground level to prevent tripping.
- ✧ Corkscrew Anchors are not included
- ✧ Be sure the swing set is located on level ground
- ✧ Turn the corkscrew anchor into the ground until only the hook end is above the ground next to the leg.
- ✧ Insert the hooked end into the bottom opening of the leg.
- ✧ Ensure that the hooked end is secure in the leg opening.

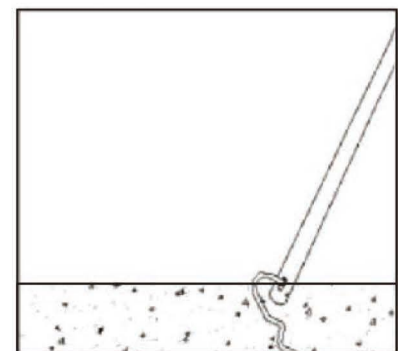
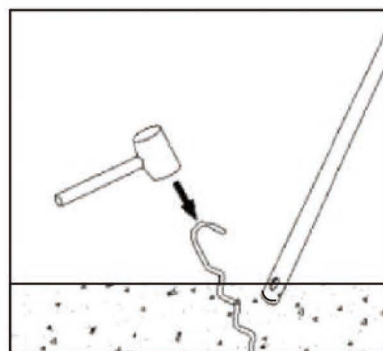
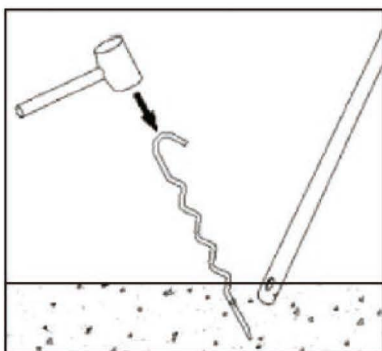

NOTE: ANCHORING

- ✧ If the swing set is set up on grounds with sandy soil conditions, it must be anchored with concrete footing (concrete not included)
- ✧ Be sure the swing set is located in level ground
- ✧ Dig holes around swing leg tube as shown below in drawing. As you dig down

and create a cylindrical hole, you should use shovel to crave out the lower part of the hole, to create a large diameter hole bottom

- ✧ Place 2 inches brick or gravel bed as shown in drawing below
- ✧ Use about 45lb of concrete per leg
- ✧ Cover concrete with dirt and protective surface material

