

Assembly Instruction

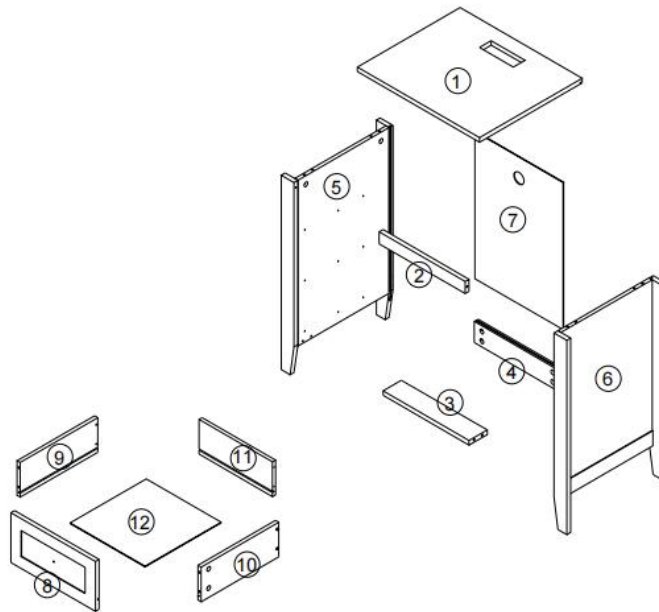















Product name

3 Drawer Nightstand

The Accessories



The Hardware

A	 M6x35	26PCS	B	 M15x10	26PCS
C	 #6x30	4PCS	D	 M4x35	12PCS
E	 M3x10	36PCS	F		3PCS
G	 M4x18	3PCS	H		1PC
I	 M3x12	2PCS	J		4PCS
K	 M3x14	4PCS	CR		3PCS
CL		3PCS	DR		3PCS
DL		3PCS			

Assembling

Step 1

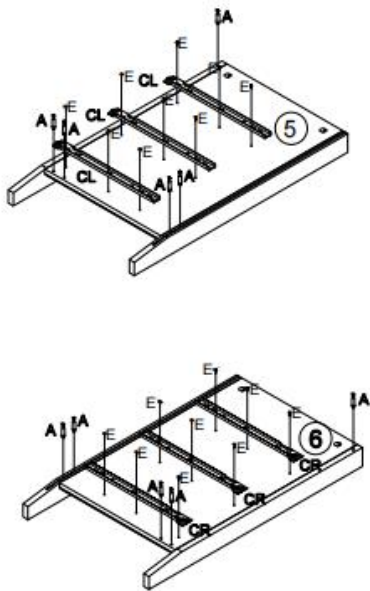

Step 2

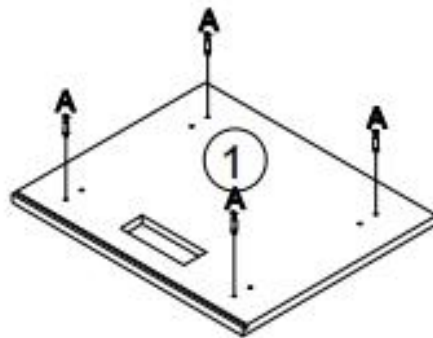

Step 3

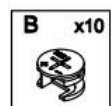
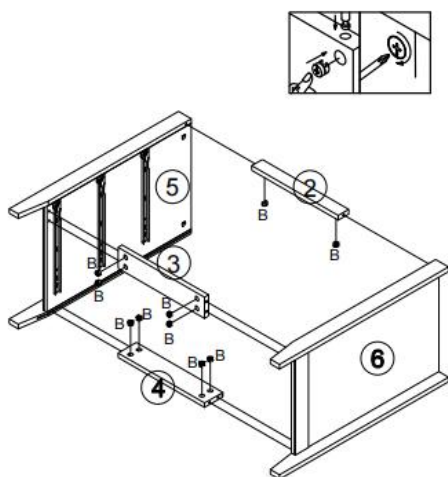

Step 4

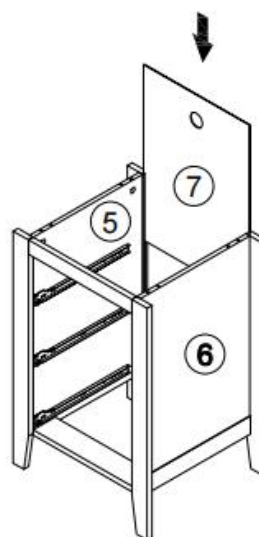

Step 5

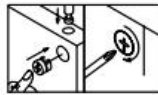
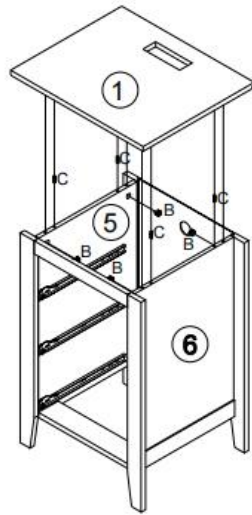

Step 6

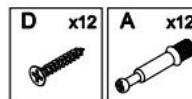
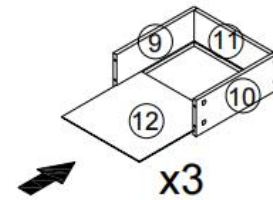
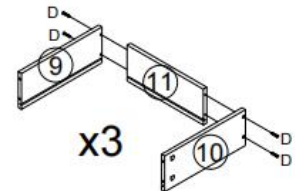
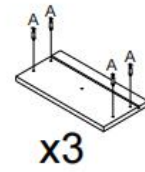

Step 7

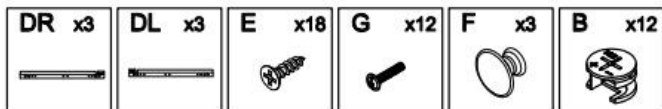
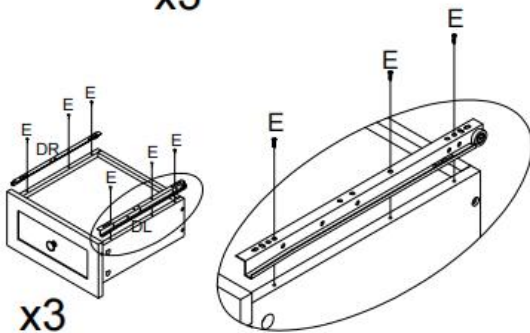
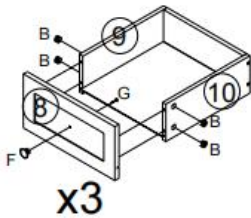

Step 8



Step 9

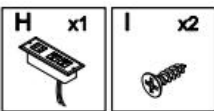
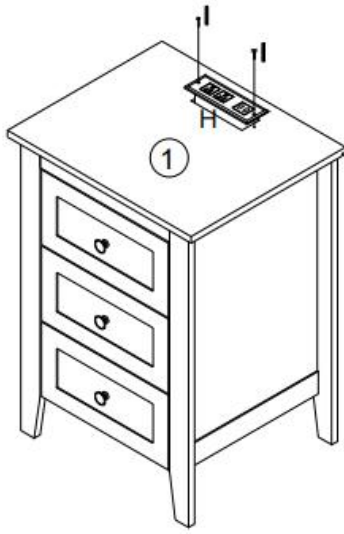

Step 10

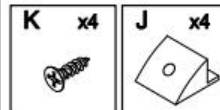

Proper Use

Please note:

Please keep small parts out of reach of children.

Always use on a level, even surface.

It is recommended that two people handle and assemble the item.

DO NOT leave spilled liquid in the cabinet

DO NOT exceed weight limit

DO NOT make temporary repairs

DO NOT use outdoors

DO NOT use this item if any parts are missing, damaged or worn.

DO NOT use this item unless all fixings are secured.

DO NOT push the item as this will damage the base.

DO NOT place the item next to a radiator or direct sunlight–this item is susceptible to temperature change. It is recommended an even room temperature be maintained with no sudden fluctuations.

DO NOT place hot or cold items directly onto the surface of the item as marking will occur. For general cleaning use a duster or damp cloth (almost dry) not wet–do not use soap and water, detergents, aerosol sprays or any polish as use of these materials would invalidate any claims.

DO NOT place the item onto wet or damp flooring as staining may occur to the floor.