

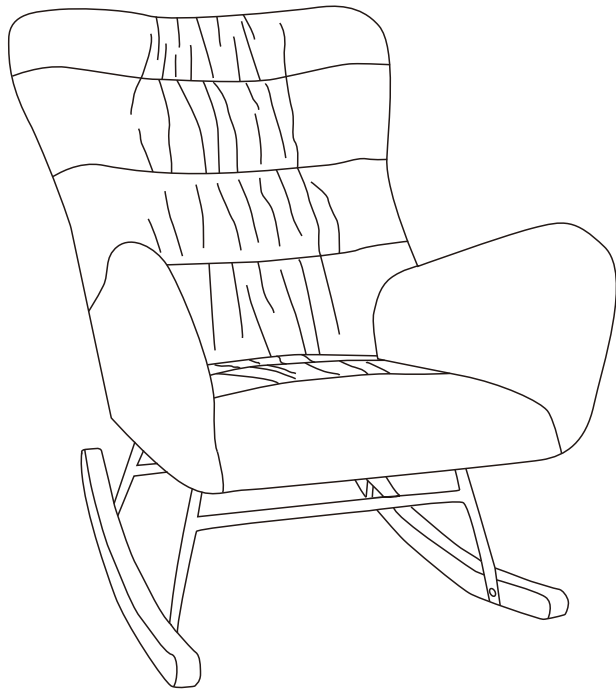

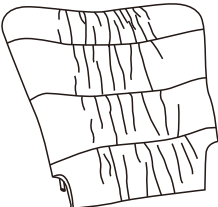

# stylor rocking chair

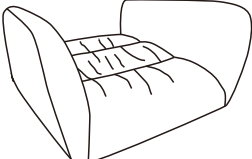
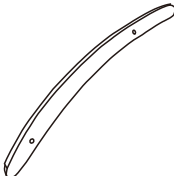
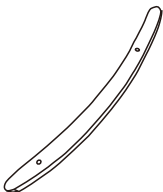
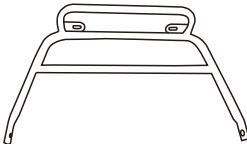
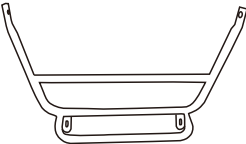

<p><b>A</b></p>  <p>x 1</p>	<p><b>B</b></p>  <p>x 1</p>	<p><b>C</b></p>  <p>x 1</p>
<p><b>D</b></p>  <p>x 1</p>	<p><b>E</b></p>  <p>x 1</p>	<p><b>F</b></p>  <p>x 1</p>
<p><b>G</b></p>  <p>x 2</p>	<p><b>H</b> M6*16</p>  <p>x 4</p>	<p><b>I</b> M6*25</p>  <p>x 4</p>
<p><b>J</b> M6*60</p>  <p>x 2</p>	<p><b>K</b></p>  <p>x 1</p>	

Attention :

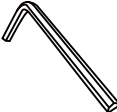
1.screws should be only 50% tight.

2.after all the screws adjust the holes then tight screws 100% totally.

1

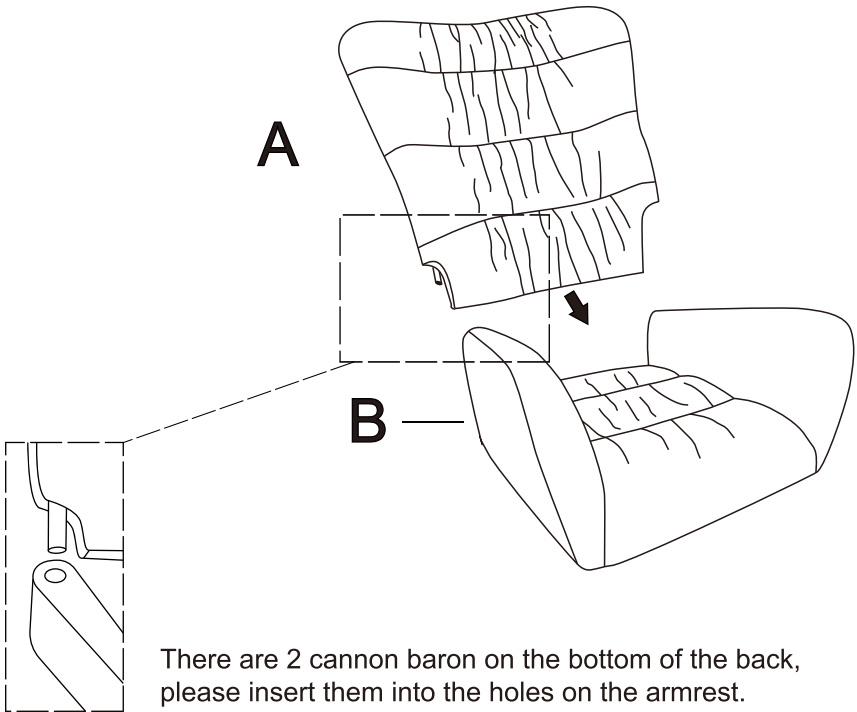

---

Attention :

1.screws should be only 50% tight.

2.after all the screws adjust the holes then tight screws 100% totally.

2

Hold the backrest  
and press down

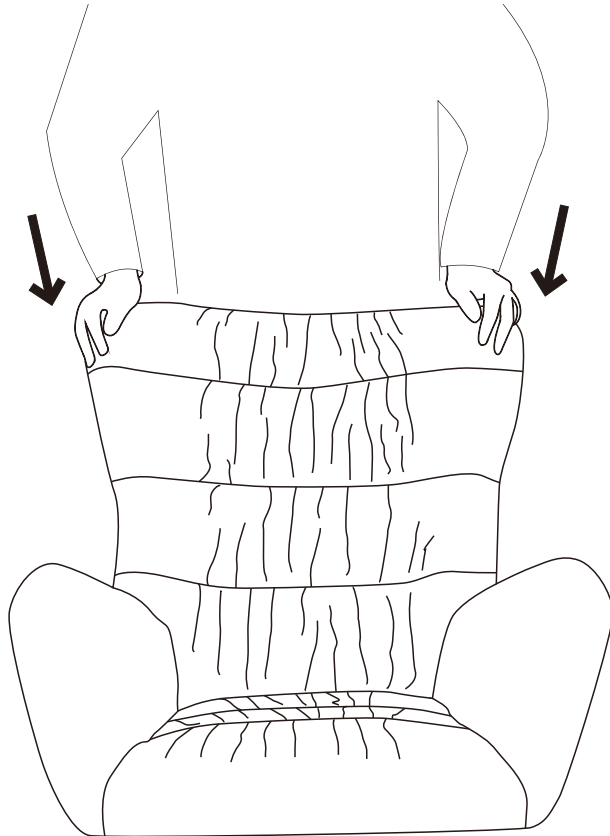



Attention :

1.screws should be only 50% tight.



2.after all the screws adjust the holes then tight screws 100% totally.

**3**

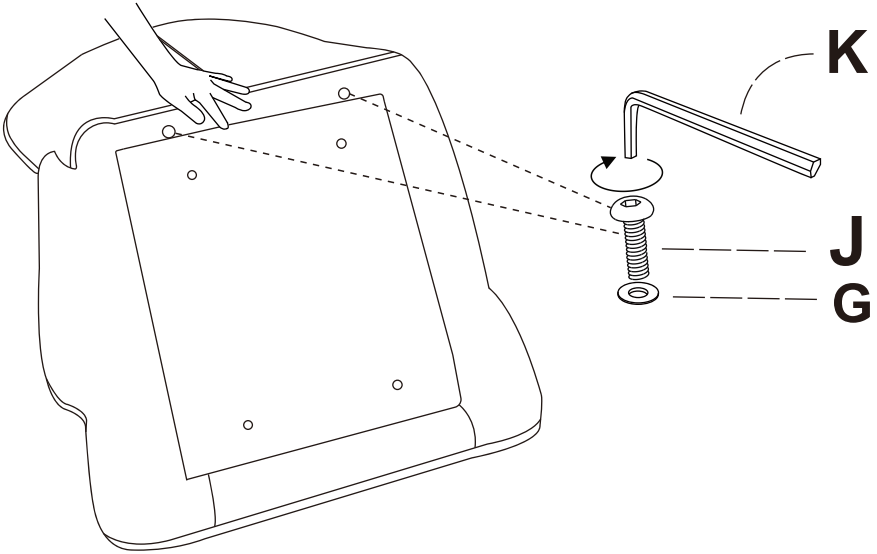
Make sure the back and the bottom tight fit, then drew the screws in, then tighten.



**X2**

<b>G</b>		2PCS
<b>J</b>		2PCS

Attention :

1.screws should be only 50% tight.

2.after all the screws adjust the holes then tight screws 100% totally.

4

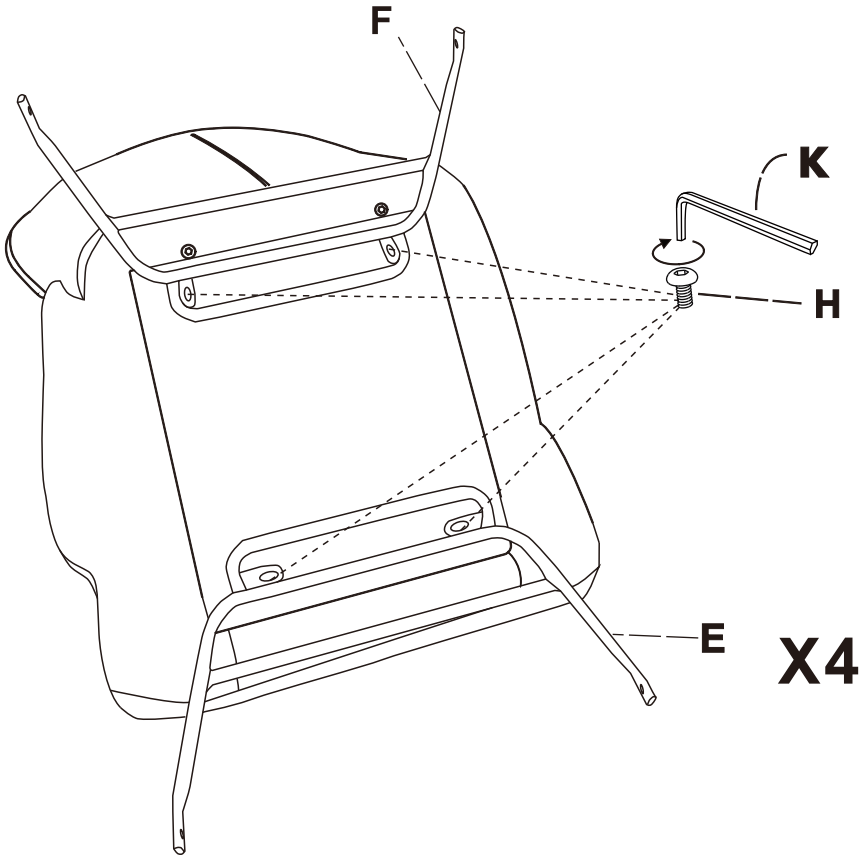

H



4 PCS

Attention :

1.screws should be only 50% tight.

2.after all the screws adjust the holes then tight screws 100% totally.

**5**

Make sure the longer side of C and D is facing the back of the chair.

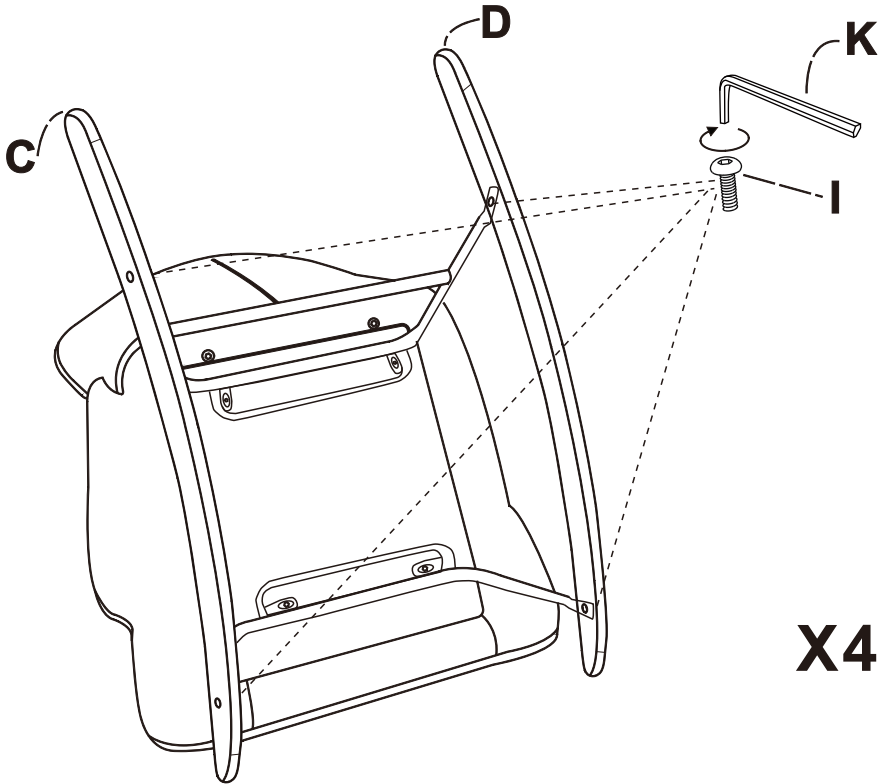

4PCS