

Shelf (A) x2

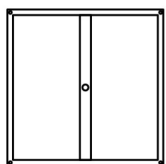

Shelf (B) x1

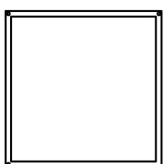

Shelf (C) x1



Square Pole (A) x4



Square Pole (B) x4

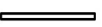

Round Boom (A) x2

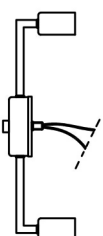

Lamp Set (A) x1

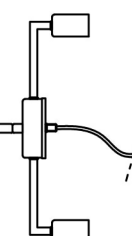

Lamp Set (B) x1



Hanging Chain (A) x1

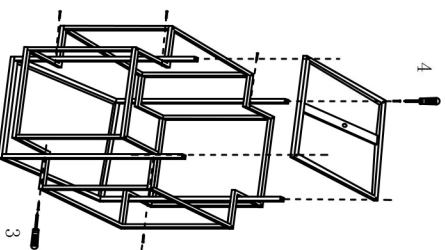
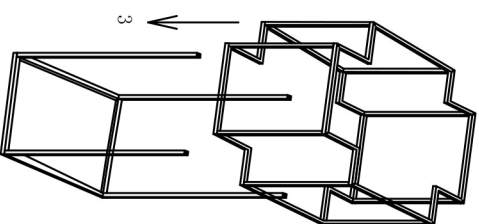
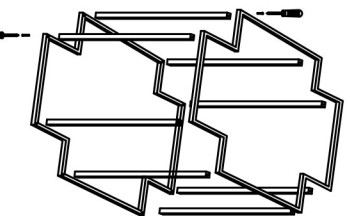
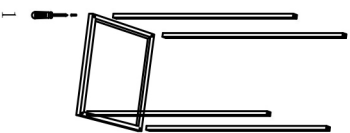

Note: When installing the light fixture, do not tighten the screws for the time being.

1. Attach shelf (C) and square pole (A) and set aside.
2. Attach the two shelves (A) with the square pole (B). As shown in Fig. 2.
3. Slide the lamp holder assembled in the 2 step into the square pole (A) of the shelf completed in the 1 step and fasten it with a dowel.
4. Fasten shelf (B) with screws and lock all the dowels of the shelf.
5. Thread the wires of the lamp set (A) into the round boom (A) to connect the lamp set (B), and twist the round boom to the lamp set (B).
6. Connect the wires of lamp set (A) and lamp set (B) and cord set together.
7. Attach the assemble lamp set (A) and (B) to the assemble lamp shelf.
8. Pass the black cord set through the hanging chain (A) and install the hanging chain on the mounting bracket.
9. Fix the mounting bracket to the junction box.
10. Connect the live wires(L), zero wires (N) and ground wires(E) to the junction box.
11. Use the black nut to lock the lamp body on the bracket. As shown in the figure.
12. Install the E12 light bulb.

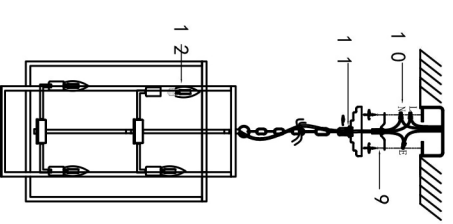
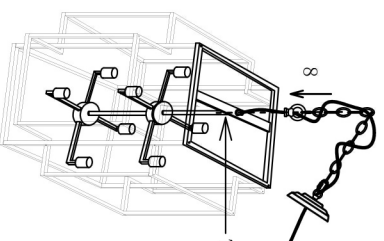
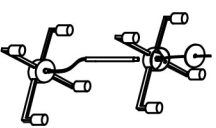
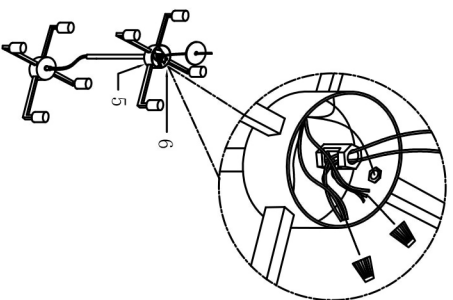

WARNING

(To reduce the risk of fire, electric shock, or injury to persons):

1. We suggest installation by a licensed electrician.
2. Please read the instruction carefully and save it as you may need it at later time.
3. Before you start, NEVER attempt any work without shutting off the electricity until the work is done. A).
Go to the main fuse, or circuit breaker, box in your home. Place the main power switch in the "OFF" position. B).
Place the wall switch in the "OFF" position.
4. Mounting surface should be clean, dry, flat, strong enough and 1/4" larger than the canopy on all side.
Any gaps between the mounting surface and canopy exceeding 3/16" should be corrected as required.
5. Make sure that the ceiling or wall can bear the weight of the lamp before fixture.
6. Make sure the voltage you are using is 120V. The maximum wattage is 60W per bulb.
7. Keep the lamp away from acidic objects in case of damaging the surface of the lamp.
8. When replacing bulb, you should turn off or unplug the lamp and you must wait until it is cool as bulbs get hot quickly.
9. The safety instructions appearing in this manual are not meant to cover all possible conditions that may occur.
It must be understood that common sense, caution and care must be used with any electrical products.
10. Do not touch the bulb or lamp shade during the lighting fixture working.

Image for finished product:

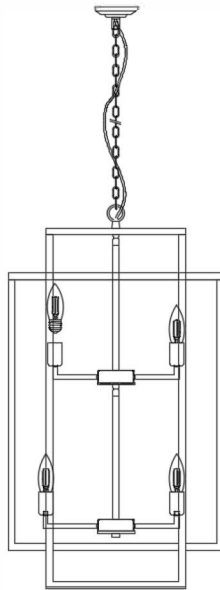

Accessories List:



screw*48



Screw



Wire connector



Instruction