

# Assembly Instructions

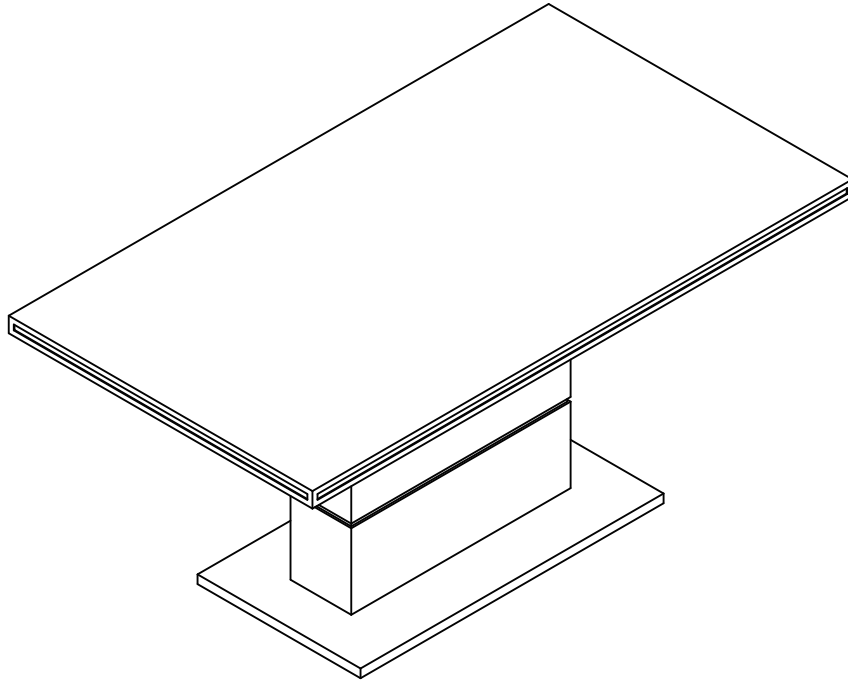

Please install the products on carpet or soft place

## Parts list

## Hardware List

No.	Sketch	Description	Qty	No.	Sketch	Description	Qty
①		Tabletop	1	A		M8*735mm	4
				B		M8	4
②		Pedestal	1	C		M8*22mm	4
				D		M5	1
③		Base	1				

## Step 1

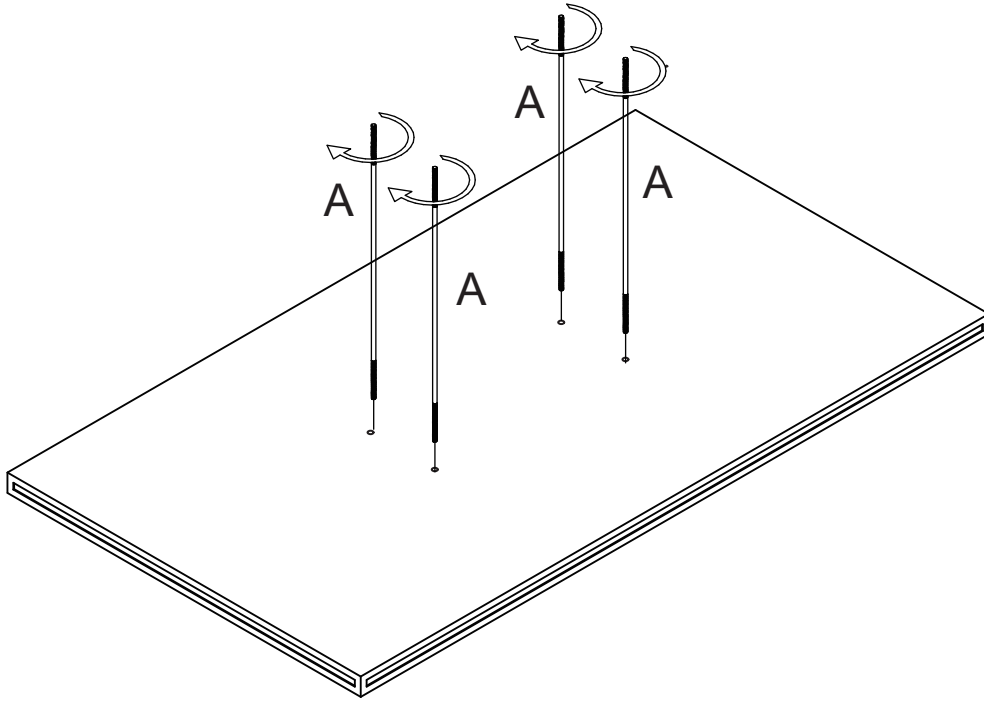

## Step 2

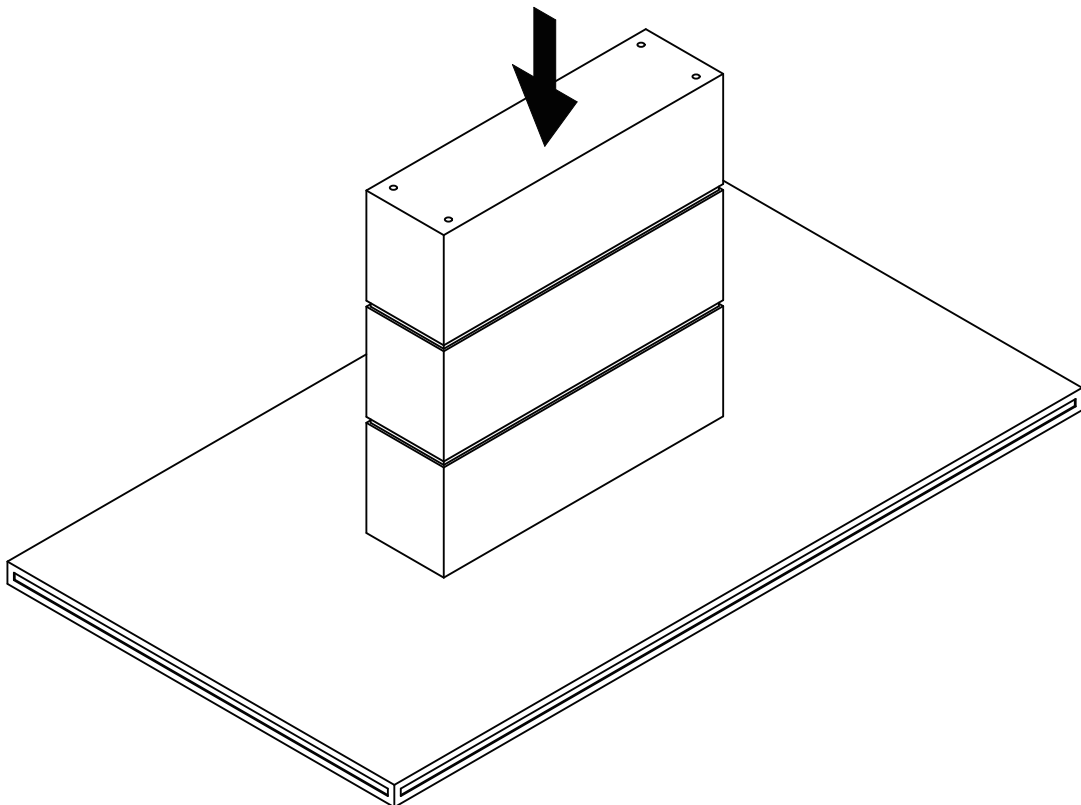

# Step 3

