

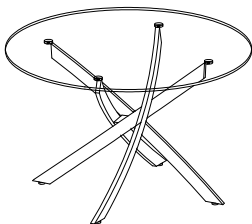



Assembly Instructions







Please install the products on carpet or soft place

Parts List

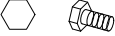
No.	Sketch	Description	Qty
A		Glass Top	1
B		Leg	4
C		Iron Box	1
D		Adjustable Feet	4

Hardware List

No.	Sketch	Description	Qty
1		Bolts M8x16	8
2		Bolts M8x8	4
3		Offset Ring Spanner	1
4		Allen Key	1

STEP 1

The hole spacing corresponds to the leg

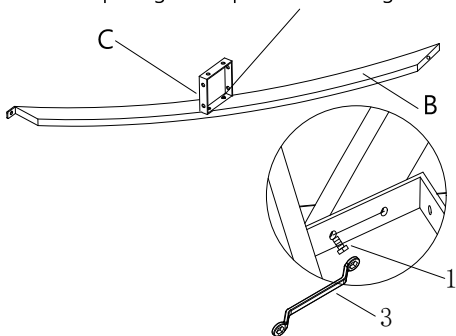

Note: The opening direction of the box should be consistent with the picture



50% tighten all the screws

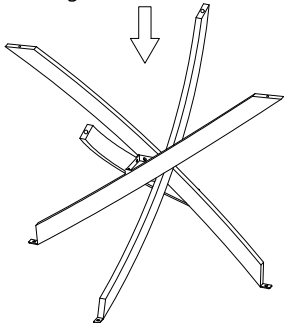

STEP 2

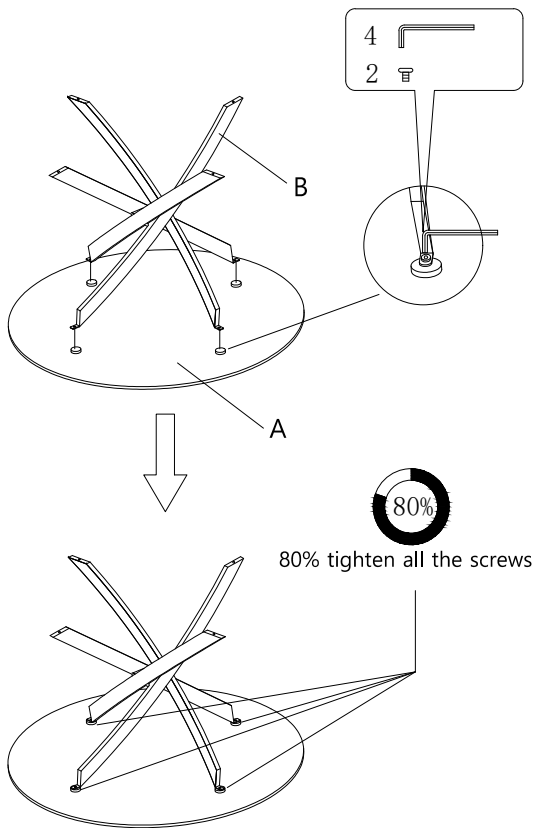

STEP 3

1.



80% tighten all the screws

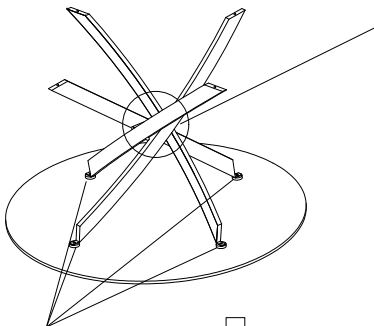

2.



Tighten all the screws

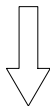

After aligning feet

3.



Tighten all the screws

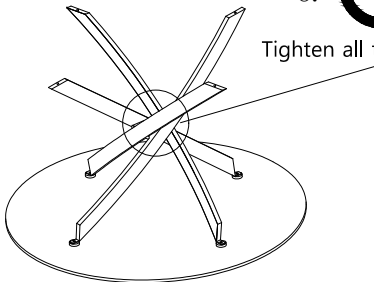

STEP 4

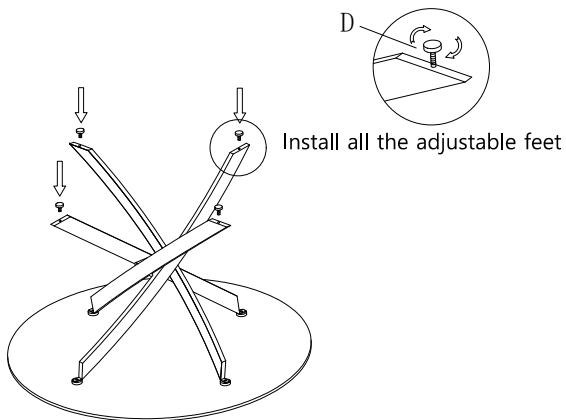

COMPLETED

