

# Installation instructions for Thermostatic Faucet

Please read the installation manual before installation and use

Thank you for choosing our sanitary ware products. This product will serve your health wholeheartedly and make your life more comfortable, more perfect and more fashionable. Please read the installation manual carefully before installation and use.

This manual applies to the installation and use of all similar products. Part of functional structures of the product are subject to change without notice. Subject to the actual sample, the final interpretation right belongs to the company.





## Table of Contents

1. Installation Environment	... .. 1
2. Installation Aids	... .. 1
3. Parts List	... .. 1-2
4. Installation Size	... .. 3
5. Installation Method	... .. 4
6. Test Method	... .. 5
7. Cleaning Care	... .. 6

## I .Installation Environment

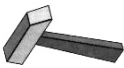
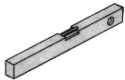
1. Before installation, confirm whether the inlet pipe and angle valve are correct. Make sure that the installation is completed, and the water has been flushed to ensure that there is no impurities in the water inlet pipe;
2. Water inlet pressure requirements: 5bar  $\geq$  inlet pressure  $\geq$  0.5bar, it is recommended to install a pressure reducing valve if it is greater than 0.05MPa;
3. When installing and using the faucet, please use normal torque to prevent the handle from breaking.
4. If the customer goes out for a long time or does not use the faucet for a long time, please close the faucet valve and turn on the faucet switch to release the pressure and water in the faucet.

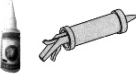
## II .Installation Aids

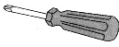
Hammet 	Spirit level 	Adjustable wrench 
Glue(do not use glue containing acetic acid) 	Impact drill 	Screwdriver 

## III .Parts List

After you unpack the product, please count the accessories with the packing list. If there is a shortage, please contact the dealer immediately. The following figure and table below are for reference only.(Note: The appearance of the product may be different)

Style 一

Style 二

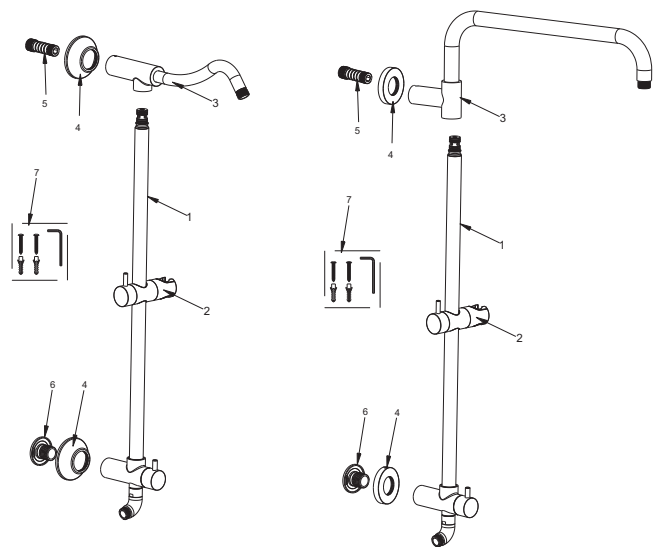

component							
No.	1	2	3	4	5	6	7
Name	water knockout drum	slider	Top shower tube	Curved foot cover	Water inlet joint	Holder	screw packet
Qty	1	1	1	2	1	1	1

#### IV. Installation Size

Before installation, refer to the product installation dimension drawing to determine the installation position. And pre-bury water pipes in the wall; flush the pipes with scrubbing tools and install the faucet to remove mud Sand, copper shavings, etc.

##### Style 一

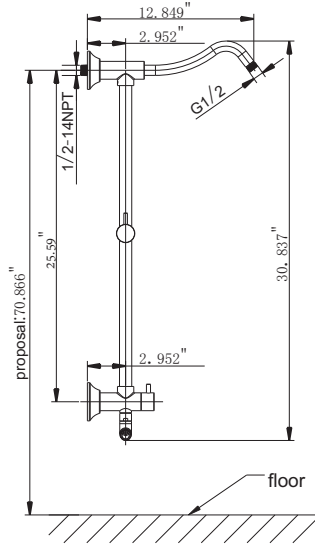

UNIT: in

##### Style 二

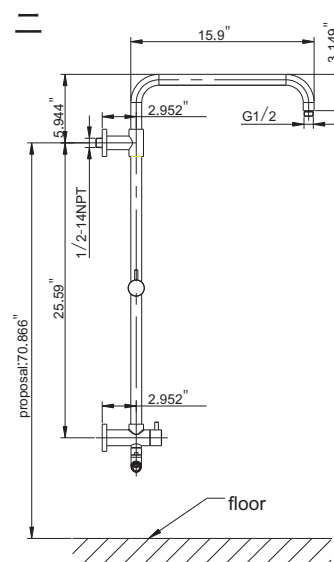

#### V. Installation Method

1. Wrap water inlet joint with the raw material tape and connect it with the water pipe embedded in the wall .
2. Attach the decorative cover to water inlet joint on the wall .
3. Measure the mounting position of the fixing seat according to the actual size of the product. After making the mark, drill a hole on the wall and punch the self-tapping rubber particles into the hole, then use the self-tapping screw to fix the fixing seat on the wall, and then set it firmly on the decorative cover.
4. Insert the water knockout drum into the top shower pipe, adjust the position and tighten it with a hexagonal wrench, and then connect it with the water inlet connector, tighten it with a hexagonal wrench, then insert the fixing seat on water knockout drum to the fixing seat on the wall, adjust the position and tighten it with a pole into the fixing seat on the wall, adjust the position and tighten it with a hexagonal wrench . If the position is slightly misaligned when the product is installed, the eccentric joint and fixing seat can be adjusted appropriately.

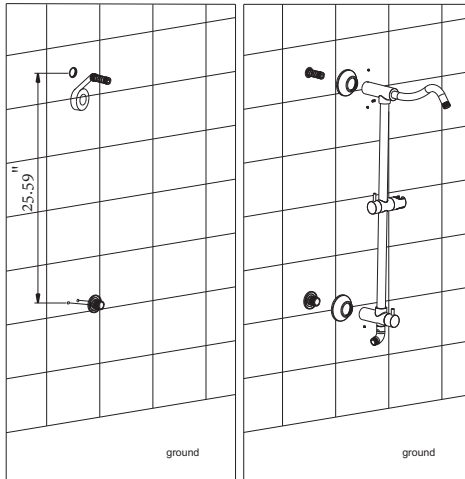

#### VI. Test method

1. Turn the faucet handle to the closed position, open the water inlet valve, and check whether there is any leakage at all water inlet ports.
2. Open the faucet handle to the maximum, and open the water inlet valve to check whether there is leakage at the water outlet and the sprinkler connection port.
3. Operate the reversing valve several times to check the shower water condition and whether there is any leakage outside the connection.
4. If the water pressure is lower than 0.05M Pa (it is possible that the faucet drips while the shower sprinkles water, or the faucet reversing valve does not work), a booster pump should be installed in the pipeline.

#### VII. Cleaning Care

1. To keep the faucet bright and clean, please clean the faucet frequently or regularly. 2. Rinse only with clean water, and dry the faucet with a soft cotton cloth.
3. Do not use detergents containing coarse particles such as decontamination powder or polishing powder, nylon brushes, emery cloth or sandpaper to avoid abrasion of the product.
4. Do not use any acidic cleaning agent, or rough cleaning agent or soap to polish.
5. When the water flow of the faucet is significantly reduced, please clean the filter screen of the shower head and the rubber particle hole of the shower water to avoid affecting the shower water or blocking and bursting. Example: The flow of water out of the shower area is obviously reduced or some rubber particles do not come out. Please scrub the shower rubber particles with your hands or use a sewing needle (toothpicks) to pass through the shower rubber particle holes.
6. If a lot of cleaning work is required, please follow the following procedures:
  - a. Use clean water or a soft cloth to remove the dirt and scale film on the surface as much as possible;
  - b. Use any of the following cleaning agents to remove surface dirt and scale film:
    - Mild liquid detergent
    - Colorless glass cleaner, non-abrasive and completely dissoluble powdered cleaner (and mix according to the manufacturing instructions)
    - Polishing fluid that is not suitable for abrasion;
    - Stubborn dirt can be bubbled with hot vinegar, then scrubbed with wax or toothpaste or with Amway special hardware cleaner.
    - To remove stubborn water stains, you can use a fresh lemon slice to wipe the water stains several times, or orange peel with sufficient water can also play a strong role in water stains. There is no need to rub the orange belt color side vigorously, the stubborn stains on the faucet can be used.
  - c. After cleaning, please use clean water to remove all the cleaning agent and dry it with a soft cotton cloth.

