

Installation Manual

Integrated bathroom basin installation steps

- One-piece bathroom washbasin bathroom cabinet installation countertop size
 Mesa length \leq basin length
 Mesa width \leq basin width

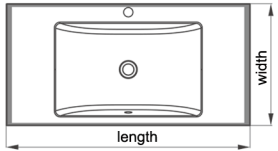
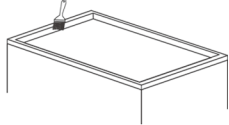

- Clean the surrounding area of the installation table before installation

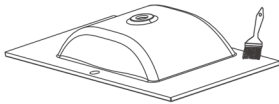

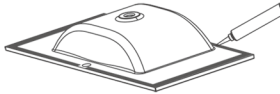
- Clean the bottom of the bathroom basin

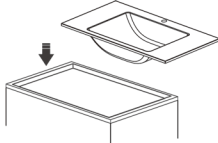
- Apply glue evenly on the back panel of the bathroom basin, pay attention to avoid the faucet hole

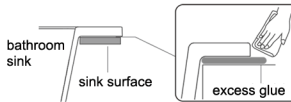
- Incorporate the washbasin into the countertop of the custom cabinet

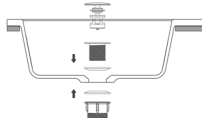

- Remove excess glue and wait for the glue to solidify (glue solidification time varies with the environment)



- After fixing the washbasin, assemble the drainer in the bathroom washbasin

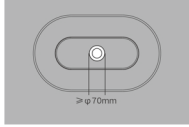

Installation steps of washbasin in bathroom on countertop

- Installation steps of washbasin in bathroom on countertop

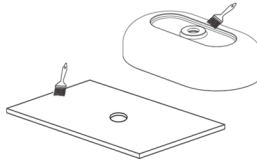
- Clean the holes and the bottom of the basin before installation

- Assemble the drainer in the bathroom basin

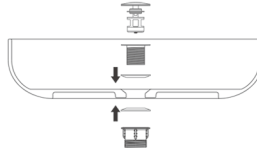

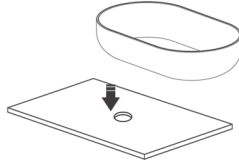
- Align the drain hole under the bathroom basin with the assembled drain unit to the hole on the countertop and place it at the hole on the countertop

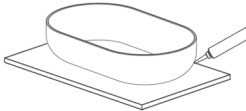

- Align the drain hole under the bathroom basin with the assembled drain unit to the hole on the countertop;

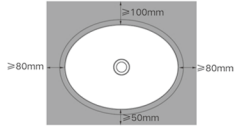

Under countertop bathroom washbasin installation steps

- The size of the opening on the countertop is slightly smaller than the size of the basin, so it is necessary to reserve the size to install the faucet

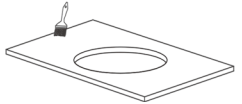

- Clean around the hole before installation

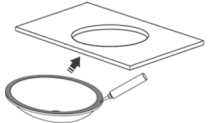

- Clean the surface of the bathroom basin

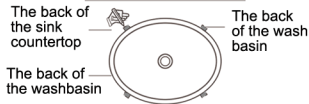

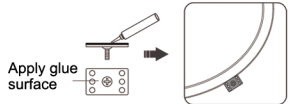
- Apply glue evenly on the surface of the basin, align with the opening on the countertop, and paste the basin on the back of the countertop

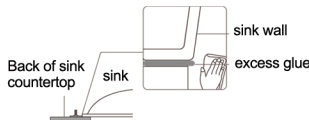

- Clean around the hole before installation

- Spread the glue evenly on the bottom plate of the fixed buckle (with screws), and then paste it on the marked position

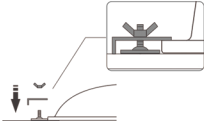

- Remove excess glue and wait for the glue to solidify (glue solidification time varies with the environment)

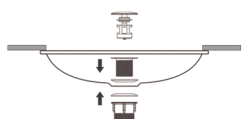
- After the glue solidifies, lock the fixed buckle with a nut to reinforce the sink



- After fixing the bathroom basin, assemble the drainer in the bathroom basin

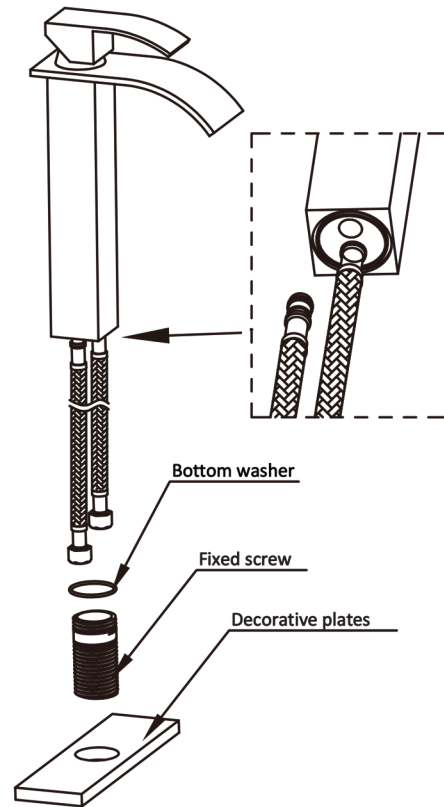
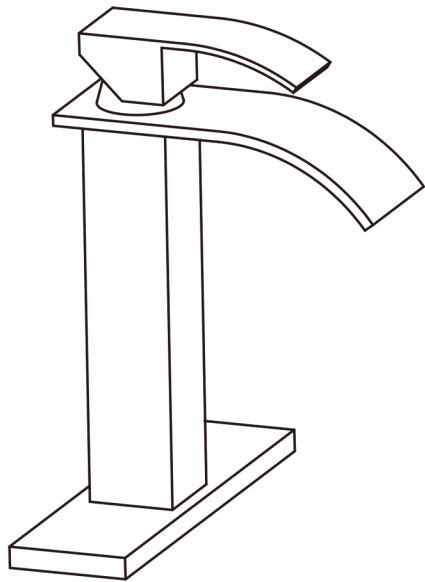

Basin faucet Installation Manual

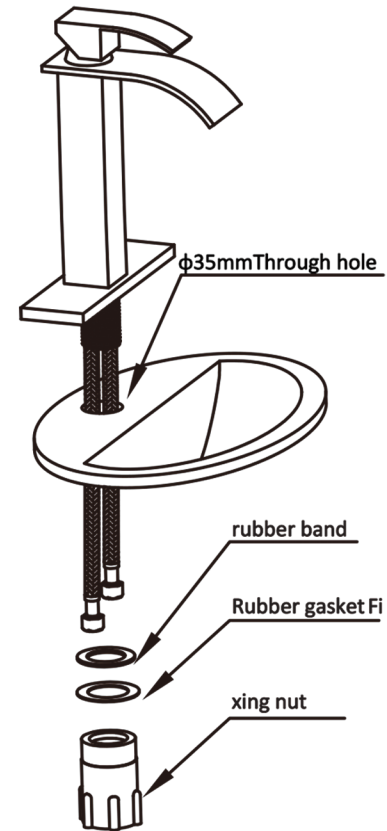

1. Connect the water inlet pipe to the faucet, then put the bottom gasket into the bottom of the faucet, then tighten the faucet with a fixing screw, and then put on the decorative panel.



2. Make sure the basin has a $\phi 35\text{mm}$ through hole, pass the hose through the hole, pass the rubber ring, rubber washer, and fixing nut into the hose in the order of the drawing, and tighten the fixing nut and the fixing screw to fix the faucet on the basin

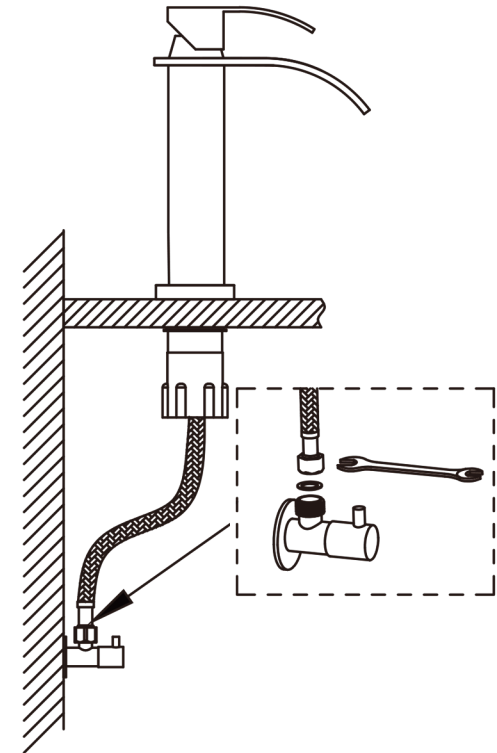

3. Connect the two inlet pipes on the main body of the faucet to the angle valve. Follow the "red" and "blue" points on the handle of the faucet, the left is red and the right is blue, respectively connecting the "hot"/"cold" water.