

COMPUTER DESK

Assembly Instruction



THIS INSTRUCTION BOOKLET CONTAINS IMPORTANT SAFETY INFORMATION.
PLEASE READ AND KEEP FOR FUTURE REFERENCE.



Ⓐ
97pcs



Ⓑ
97pcs



Ⓒ
70pcs



Ⓓ
4pcs



Ⓔ
4pcs



Ⓕ
4pcs



Ⓖ
4pcs



Ⓗ
50pcs



Ⓘ
12pcs



Ⓙ
4pcs



Ⓚ
2pcs



Ⓛ
3pcs



Ⓜ
1pcs



Ⓝ
1pcs



Ⓞ
2pcs



Ⓟ
4pcs



Ⓠ
50pcs

Parts List and Diagram

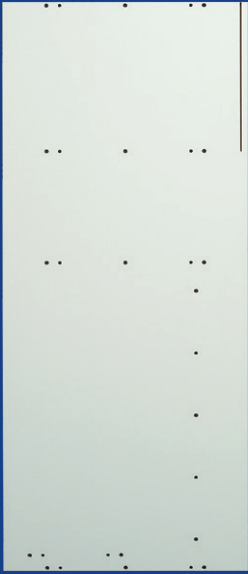

①
1PC(600x1462)



②
1PC(583x750)

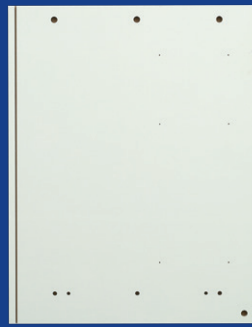

③
1PC(583x750)



④
1PC(583x750)



⑤
1PC(583x671)



⑥
1PC(583x644)



⑦
1PC(80x674)



⑧
1PC(115x320)

Parts List and Diagram



⑨

1PC(300x713)



⑩

1PC(50x750)

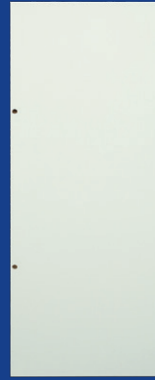

⑪

1PC(300x771)



⑫

1PC(150x771)



⑬

1PC(368x680)



⑭

1PC(295x1500)



⑮

1PC(260x685)



⑯

1PC(260x685)

Parts List and Diagram

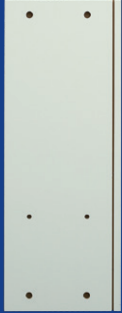

①⑦
1PC(260x685)



①⑧
1PC(260x771)



①⑨
1PC(260x644)



②⑩
2PC(200x240)



②①
2PC(240x320)



②②
1PC(209x780)



②③
1PC(329x653)



②④
1PC(478x780)



②⑤
1PC(358x653)



②⑥
1PC(50x685)



②⑦
1PC(50x685)



②⑧
1PC(60x666)

Parts List and Diagram



②⑨
1PC(60x666)



③⑦
2PC(50x172)



③①
10PC(50x172)



③②
2PC(160x380)



③③
2PC(100x303)



③④
2PC(100x300)

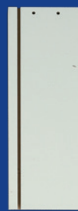

③⑤
2PC(100x300)

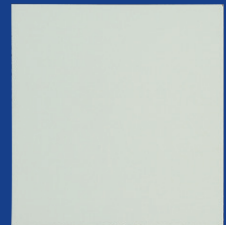

③⑥
2PC(294x313)



③⑦
1PC(342x380)

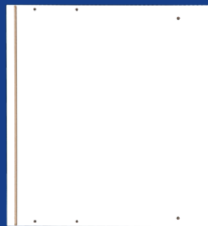

③⑧
1PC(312x333)



③⑨
1PC(150x300)



④①
1PC(150x300)

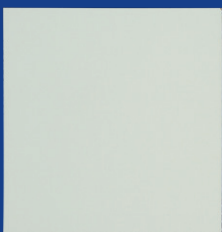

④①
1PC(310x313)

Assemble steps



step1

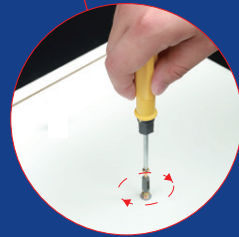
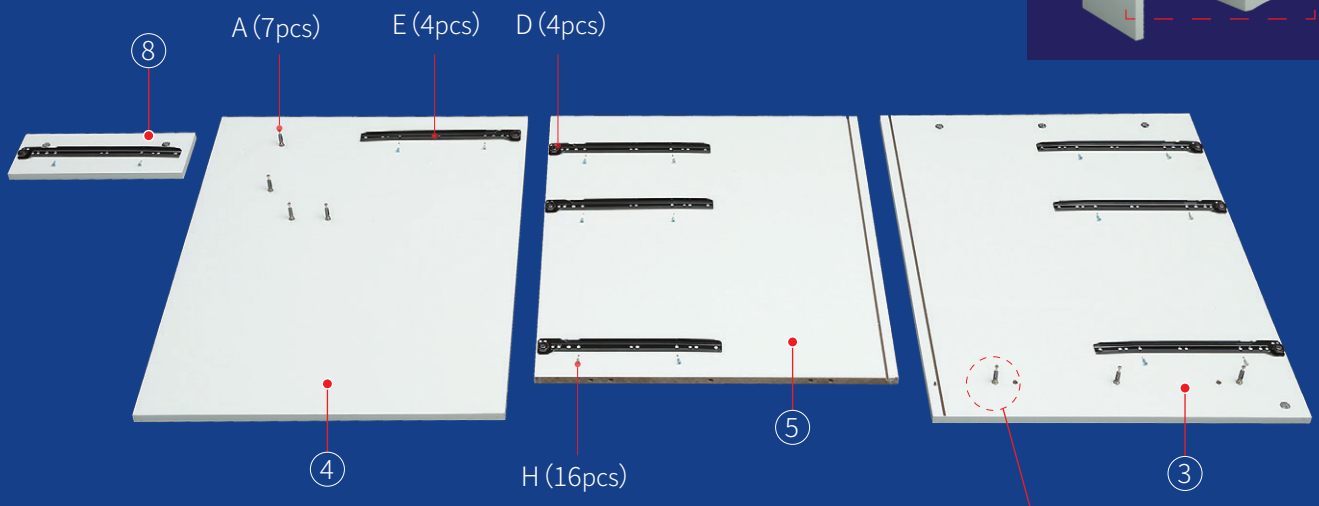

step2

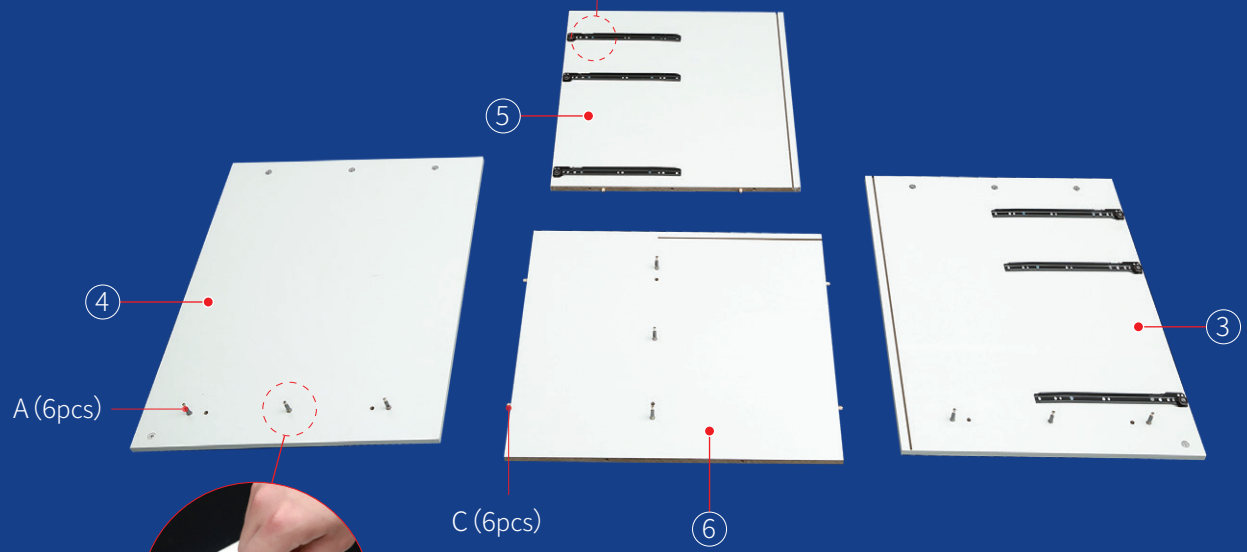

Assemble steps



step3

make sure the arrow on the screw align to the hole on the side

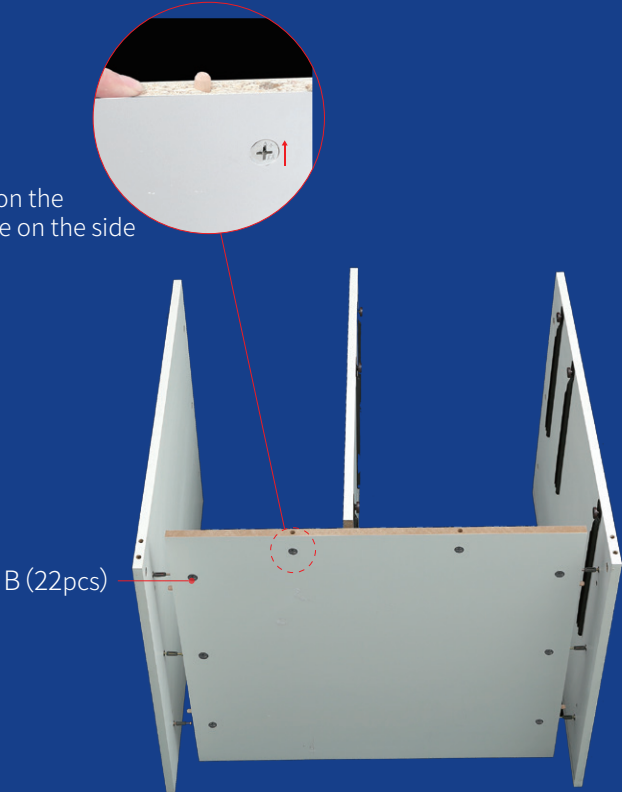

step4

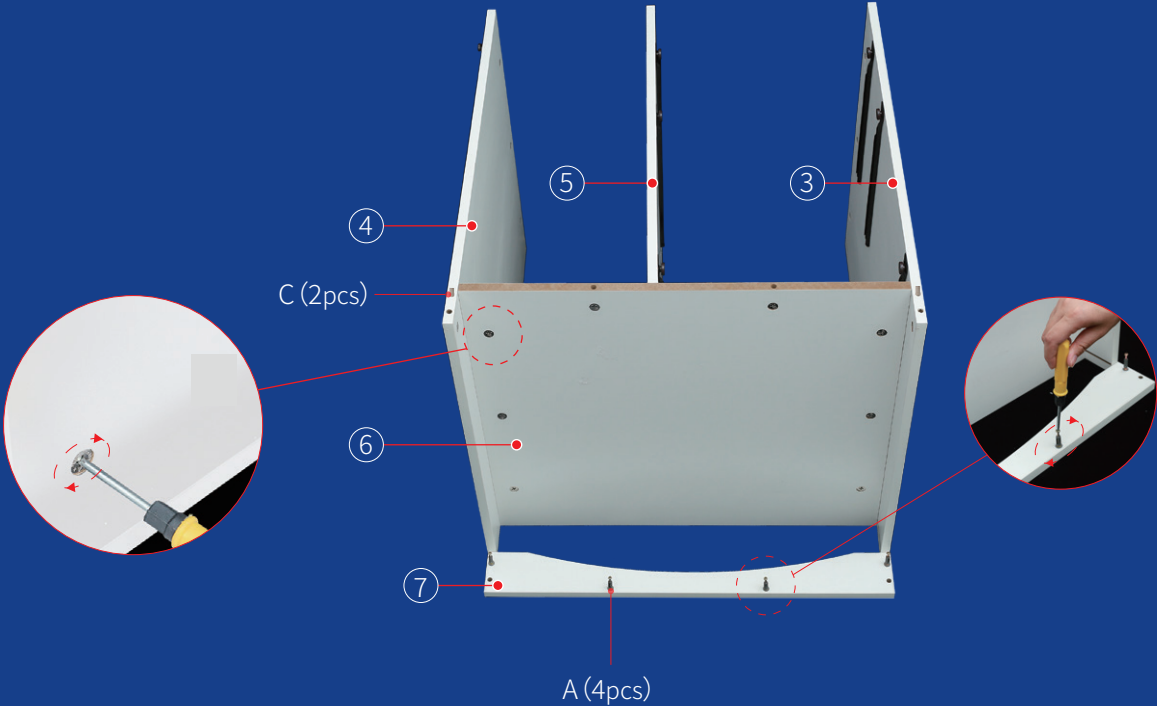

step5

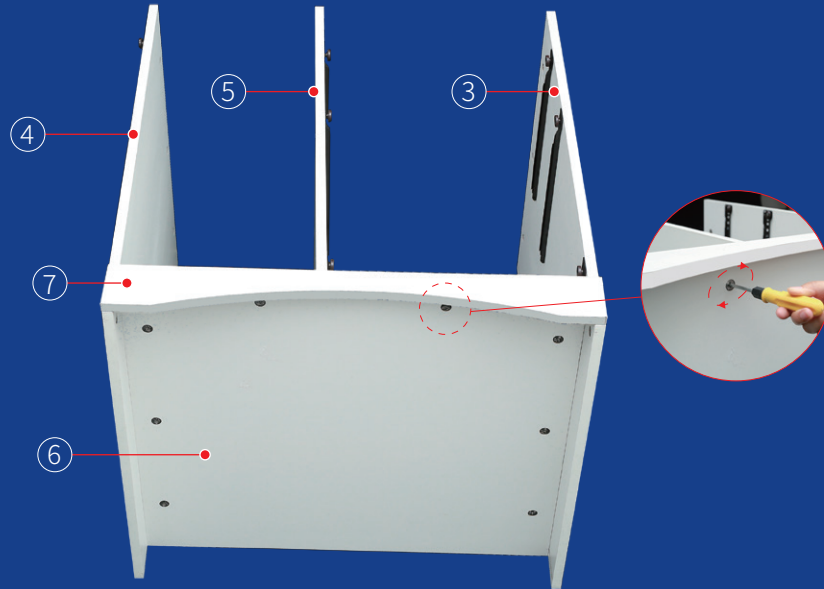

step6

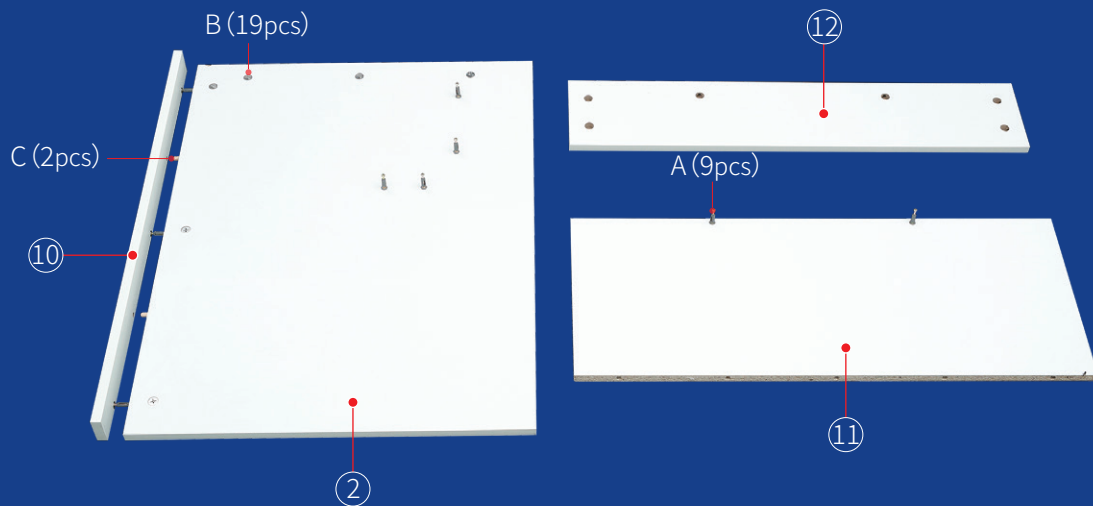

step7

make sure the arrow on the screw align to the hole on the side

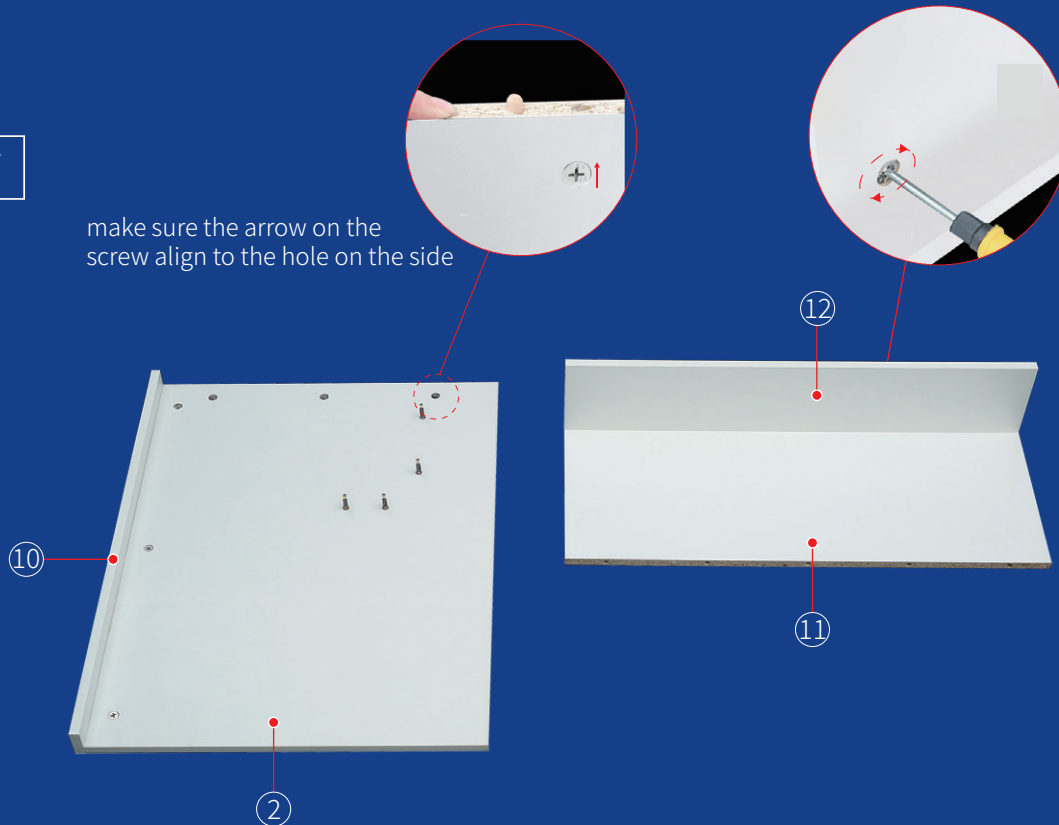

step8

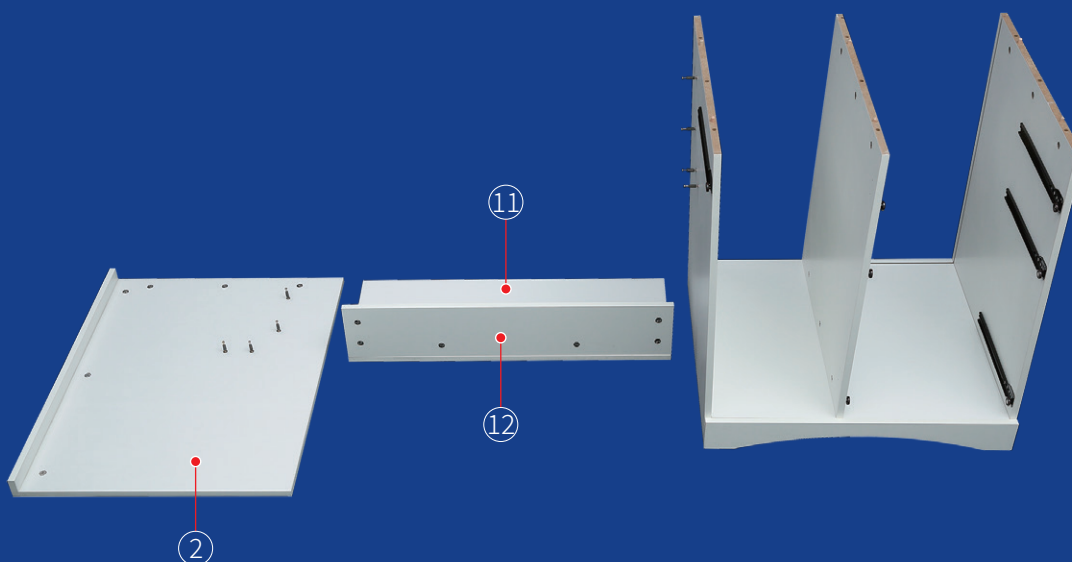

Assemble steps

step9

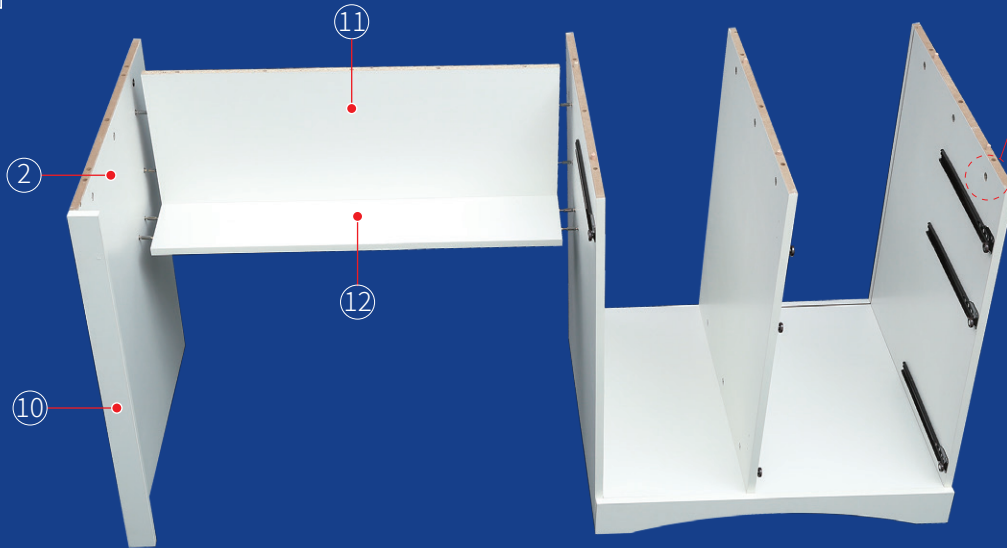

step10

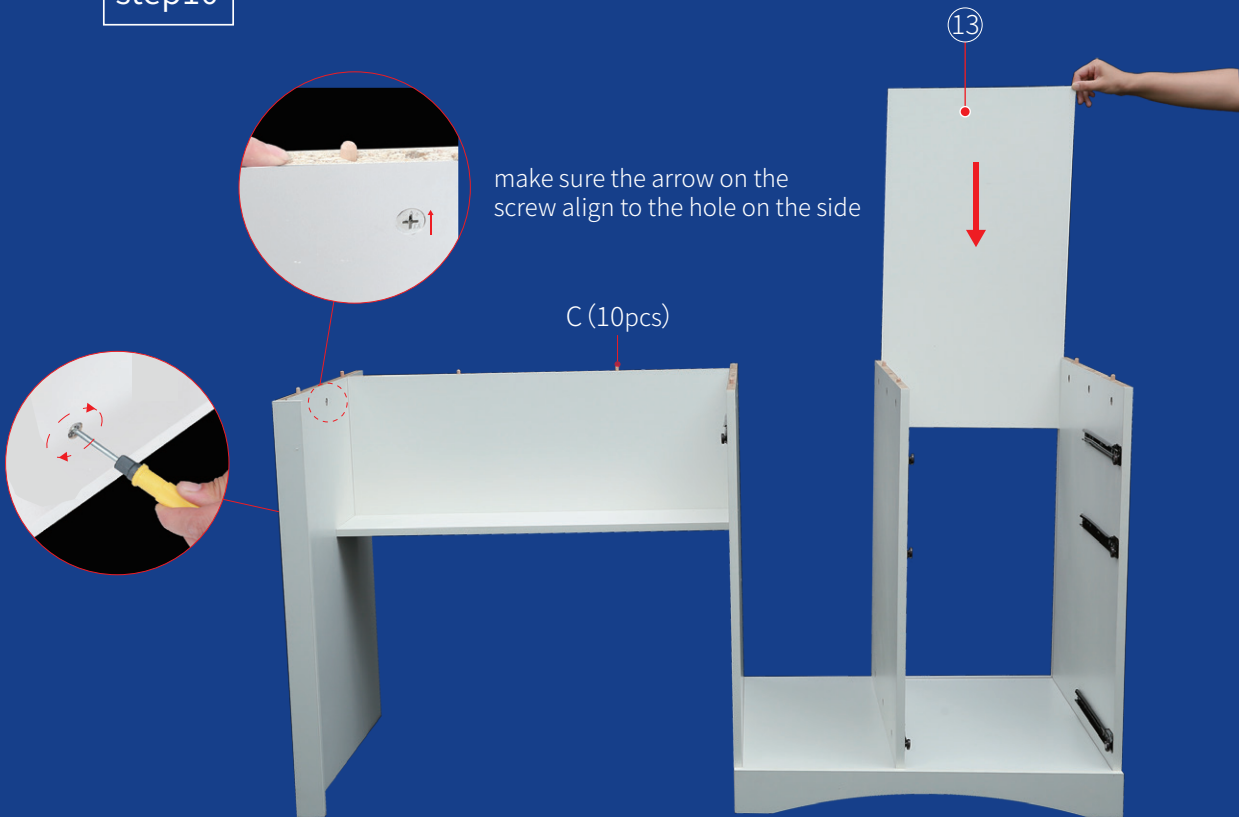

Assemble steps

step11



step12

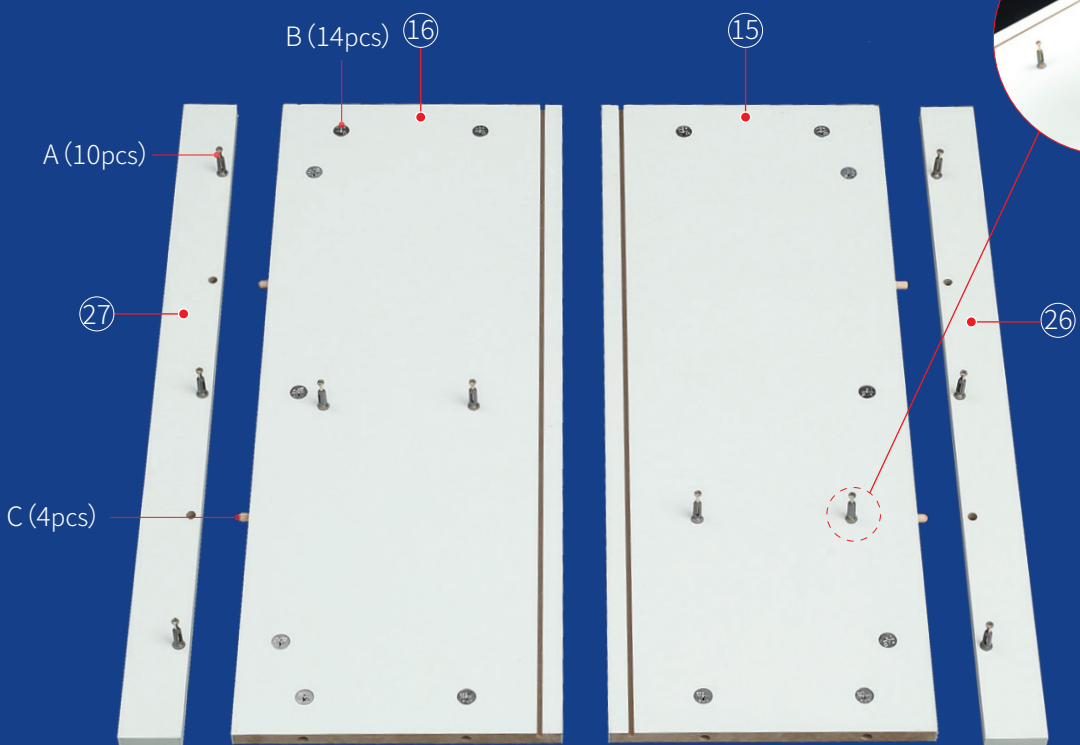

step13

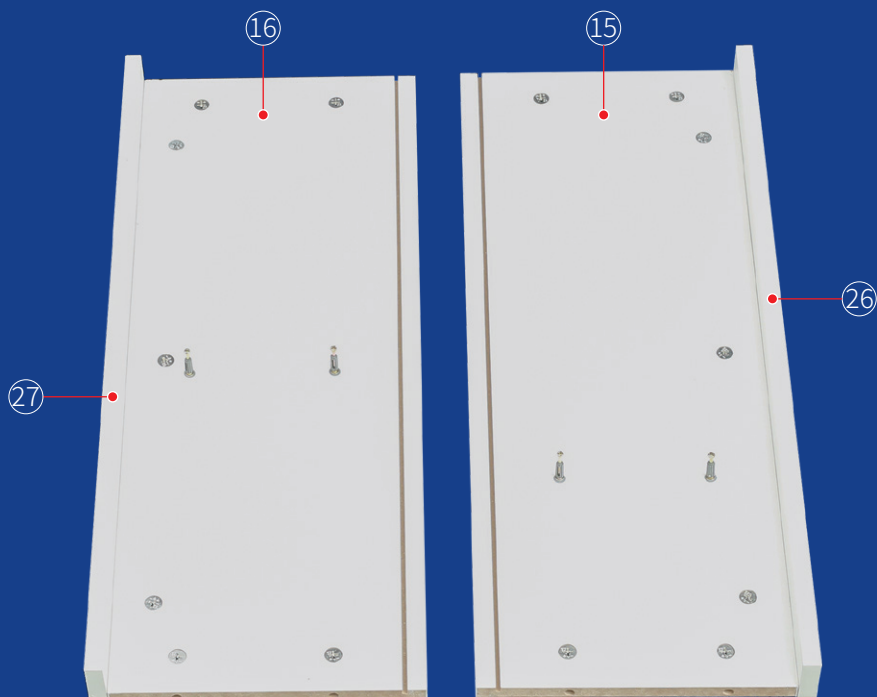

step14

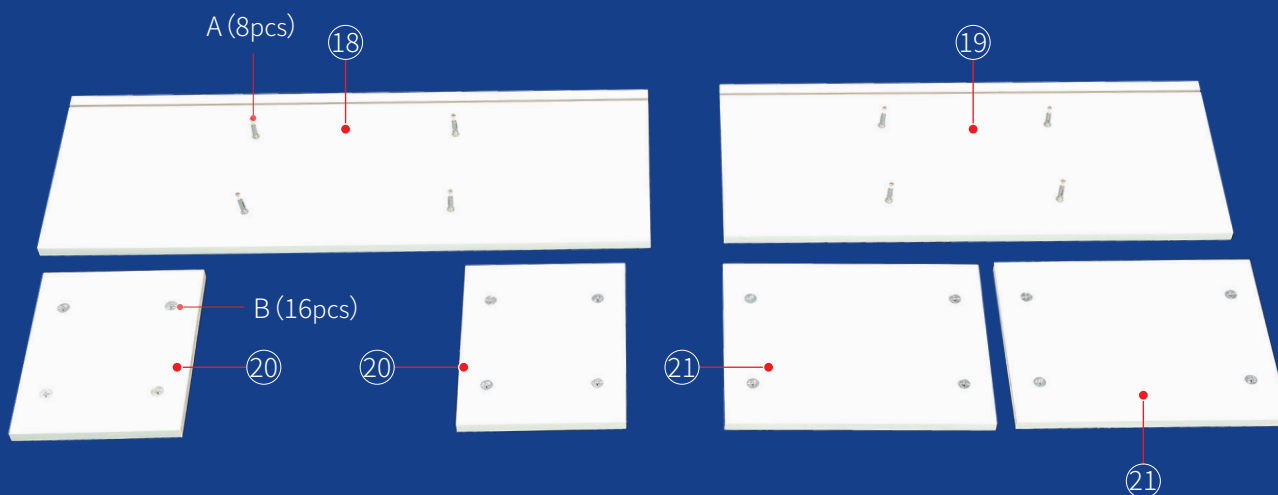

step15

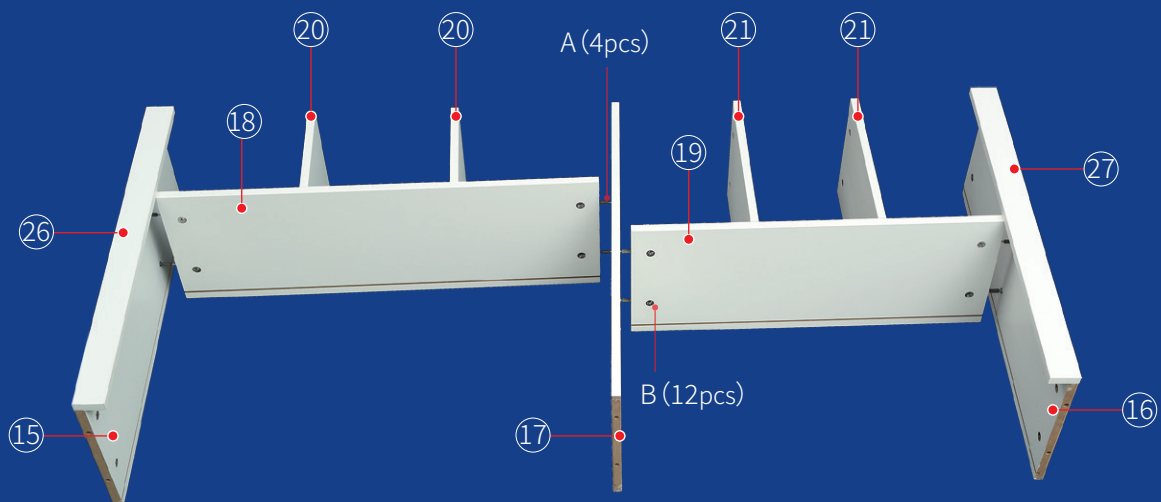

step16

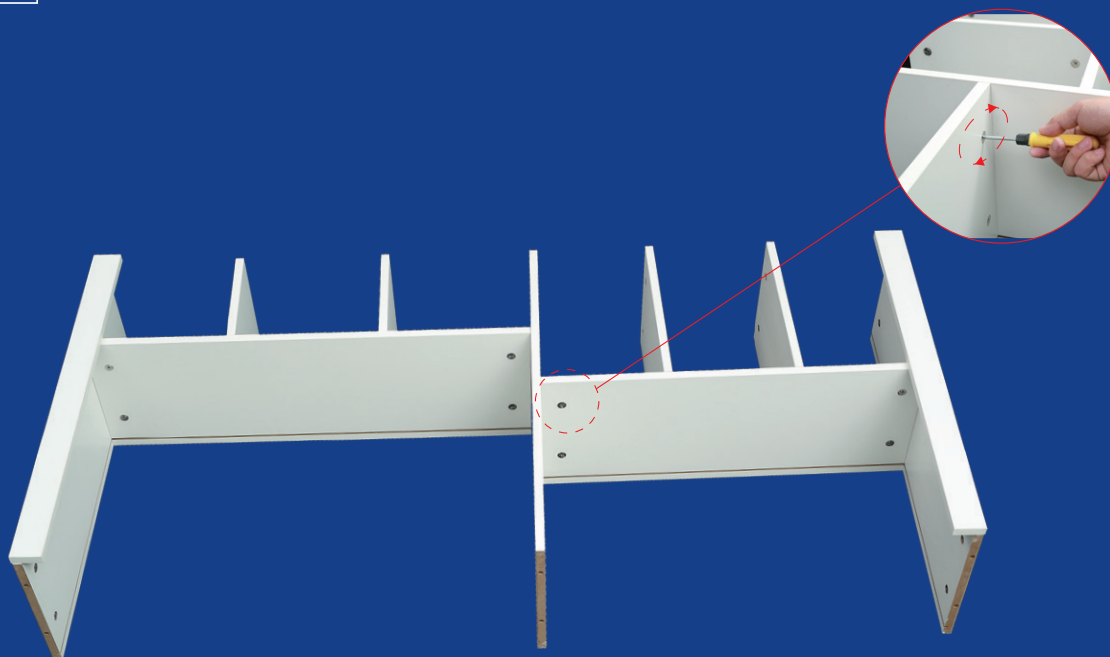

step17

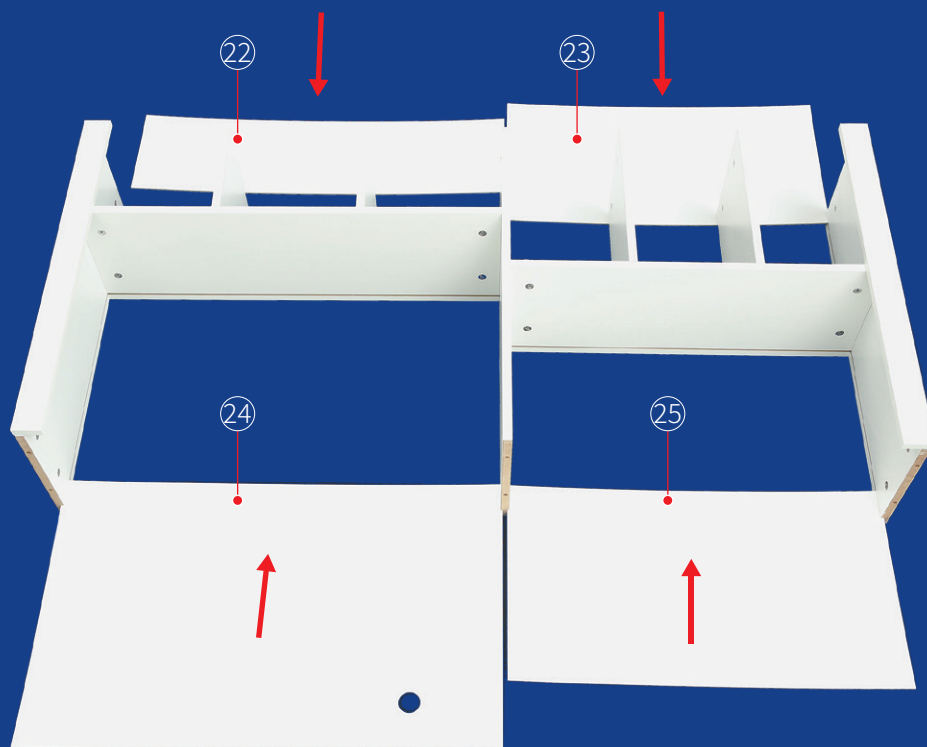

step18

make sure the arrow on the screw align to the hole on the side



Assemble steps

step19



step20

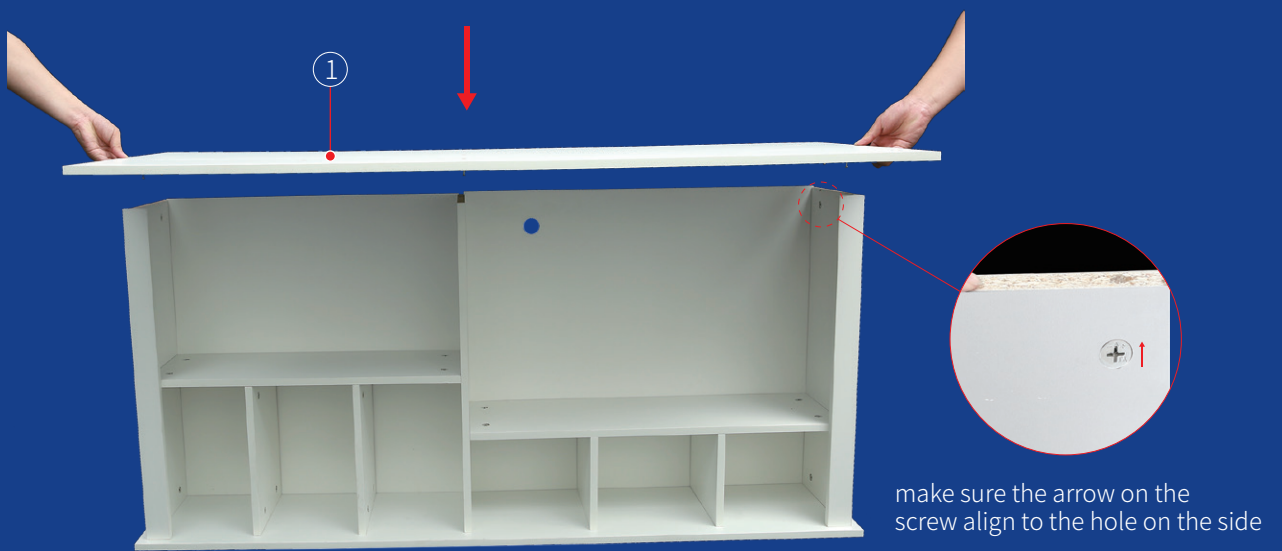

step21



step22



step23



step24



step25



step26

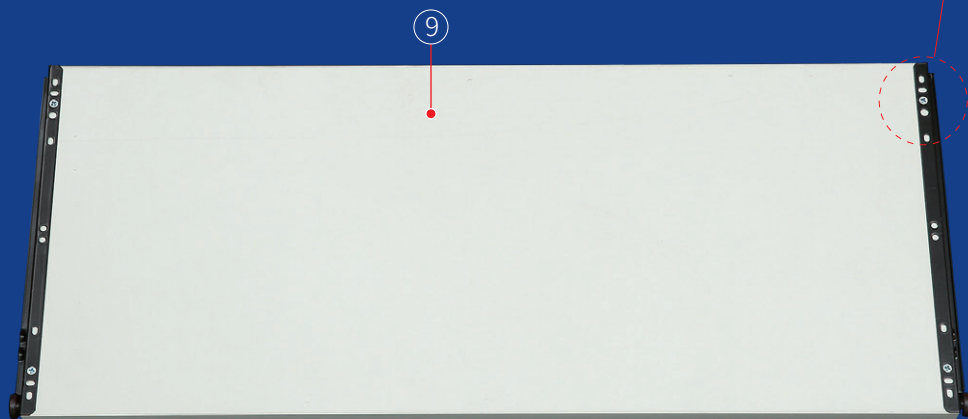

step27



step28

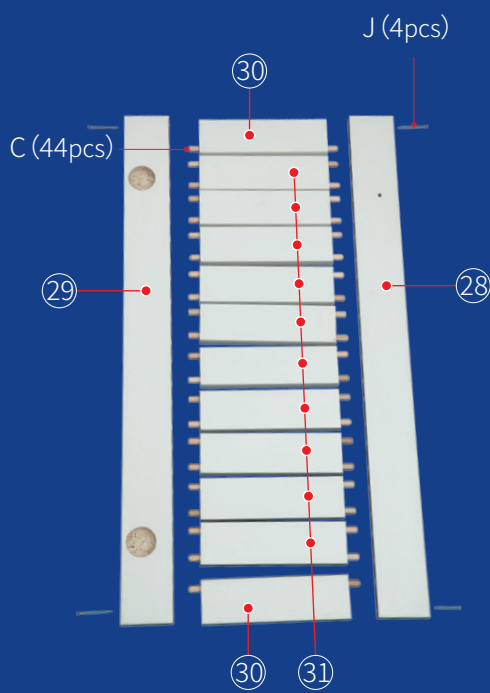

Assemble steps

step29

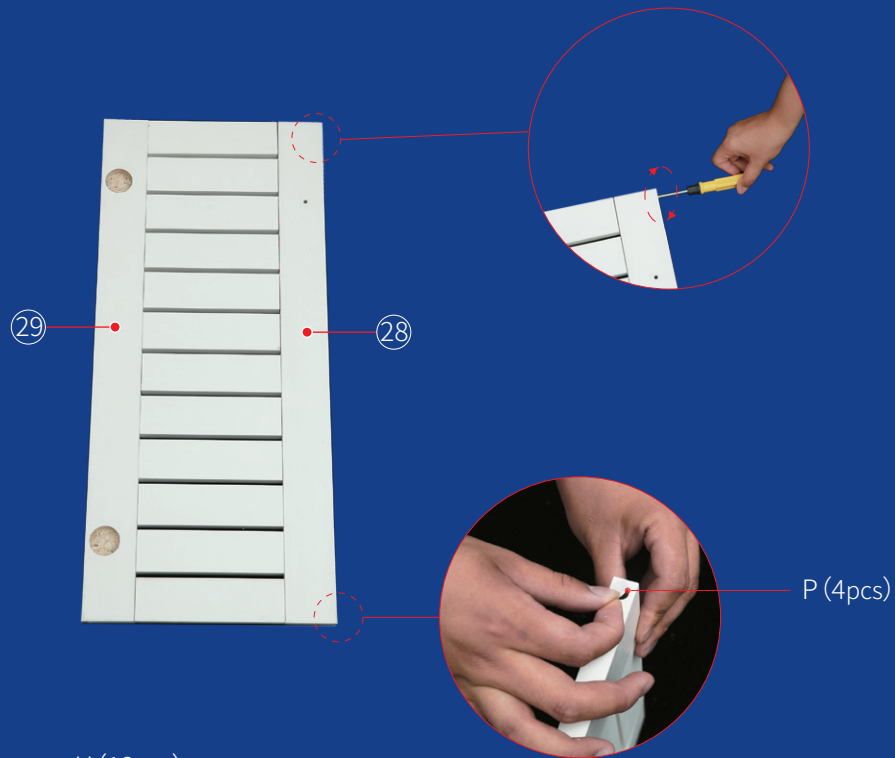

step30

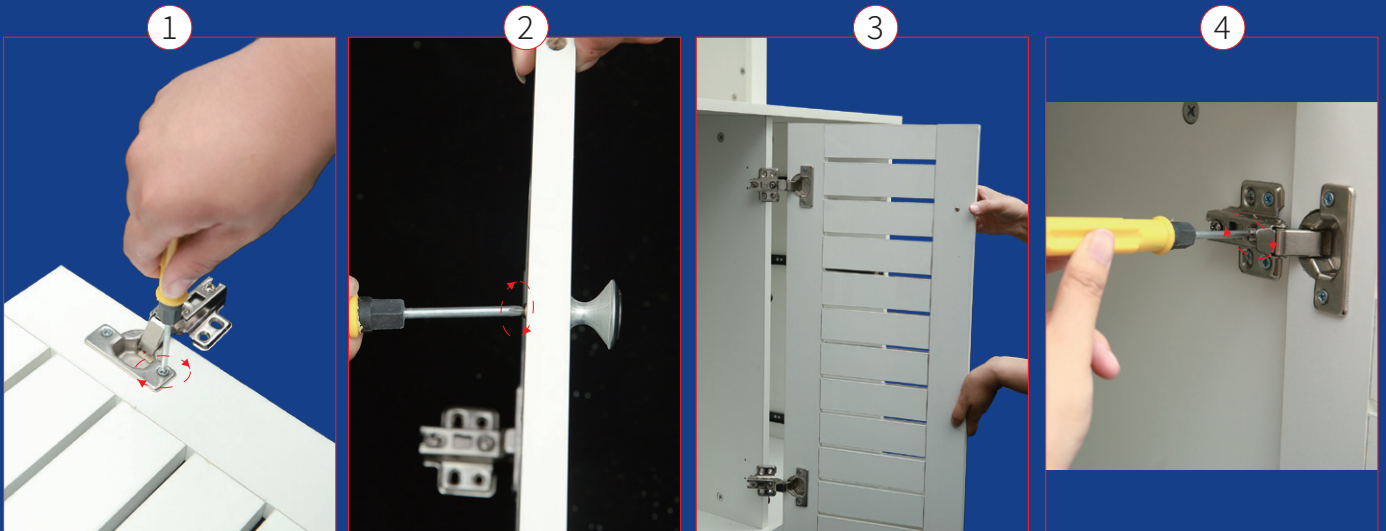
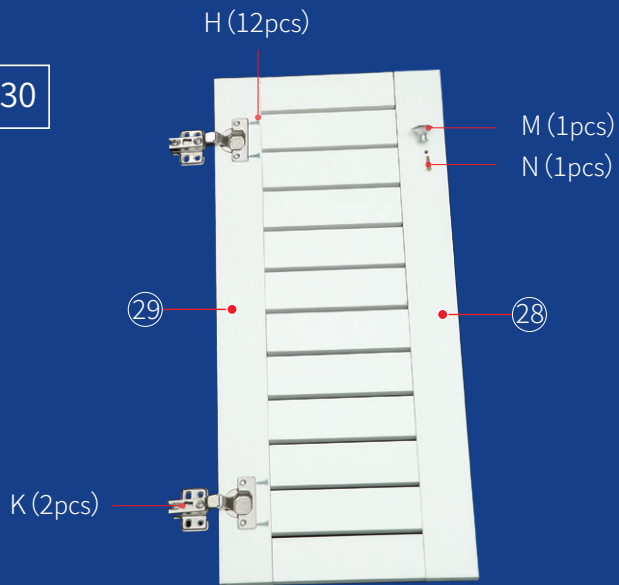

Assemble steps

step31 x2

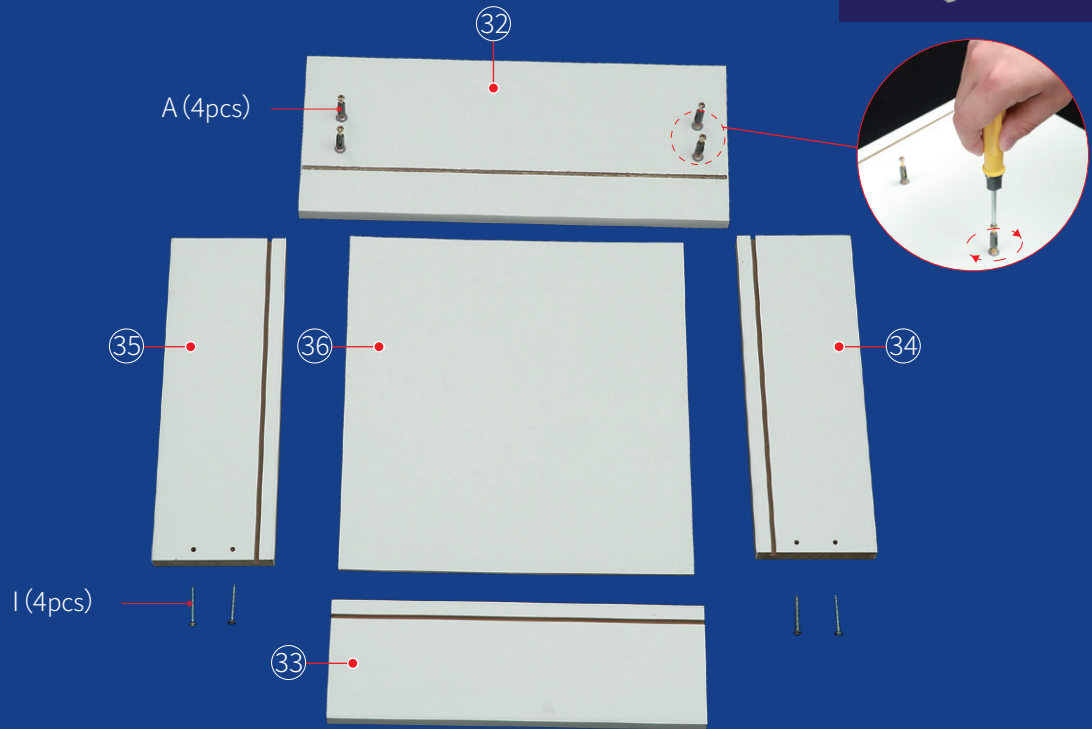

step32 x2

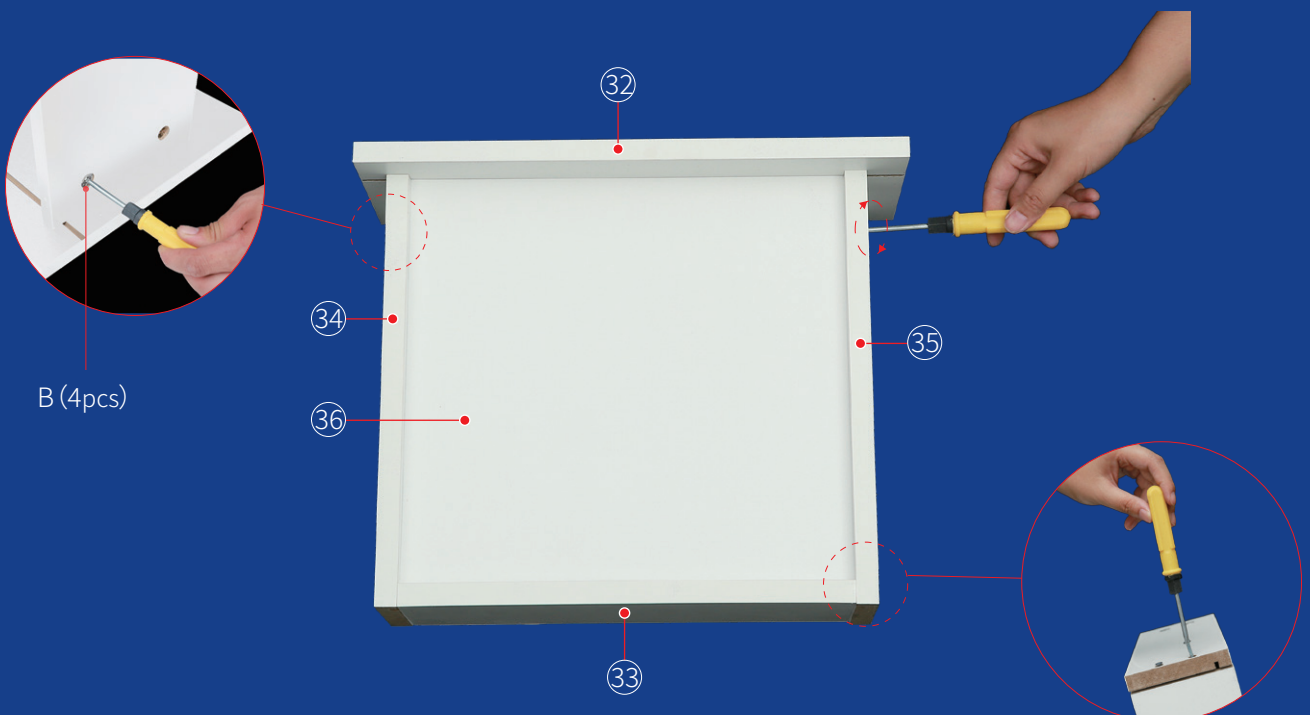

Assemble steps

step33 x2

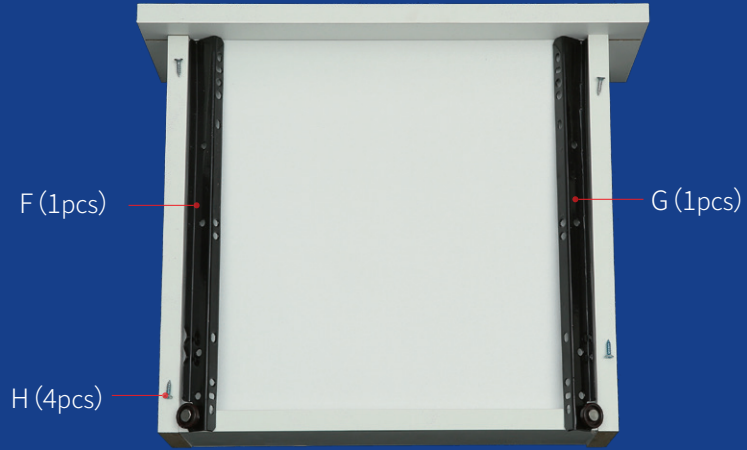

step34 x2

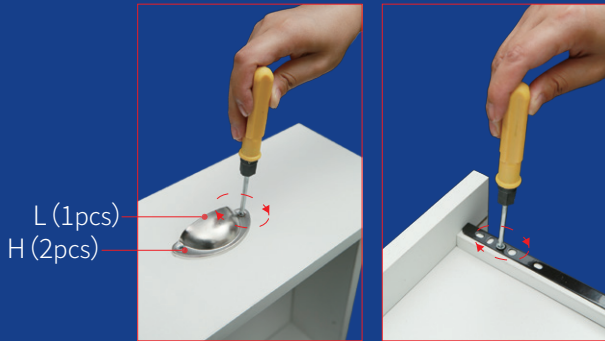

Assemble steps



step35

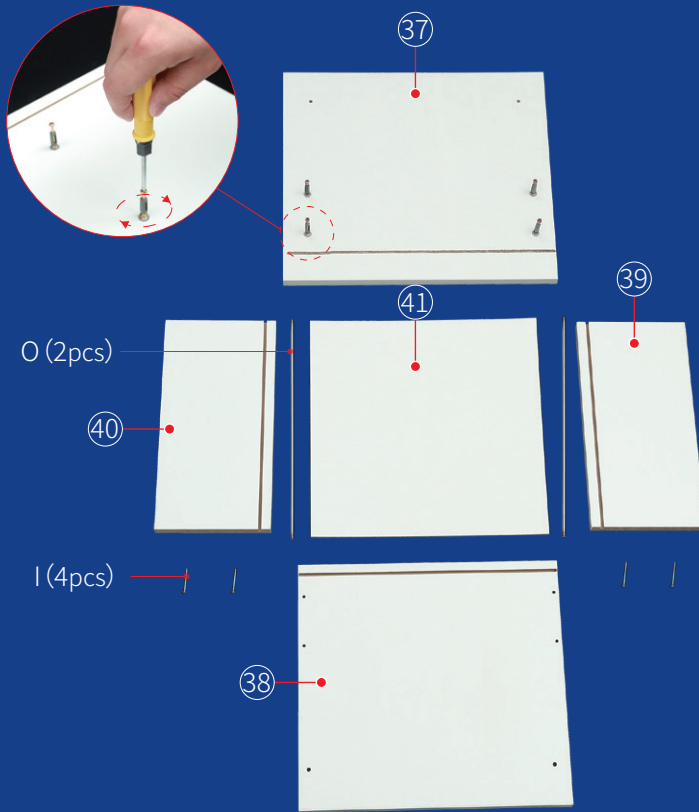

step36

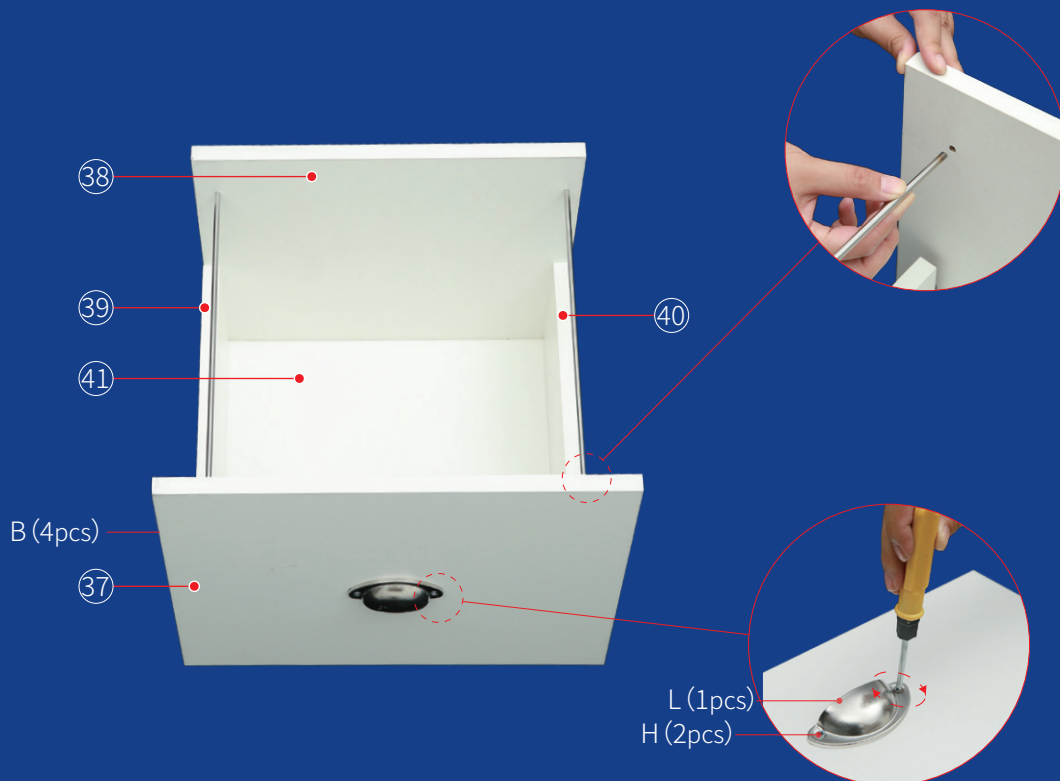

step37

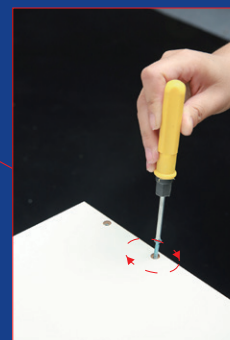
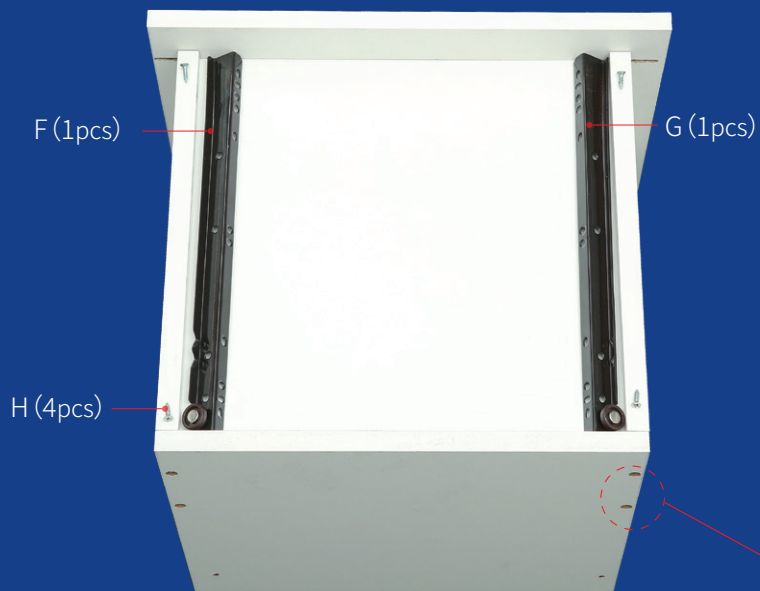

step38

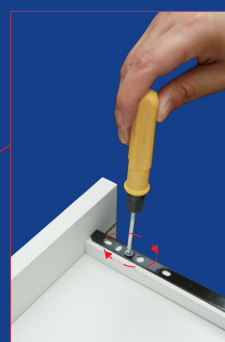

step39



step40

