

# Basin installation Instructions

Model: FS140-1500G

## Components:

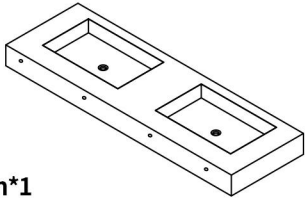

Basin\*1



Expansion Bolt\*4

<1>

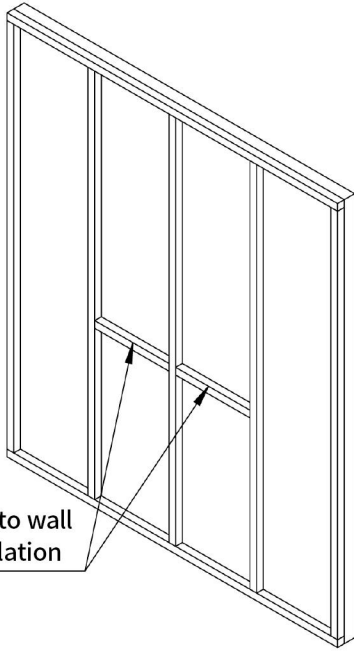

Add battens to wall before installation

**Note:** Product can be mounted on both concrete or timber-framed walls.

<2>

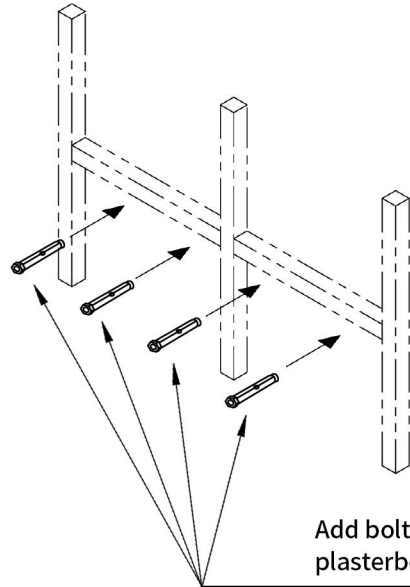

Add bolts to plasterboard

**⚠ Important!** Before installing, ensure there is sufficient timber framing in the wall to securely fasten your basin to.

<3>

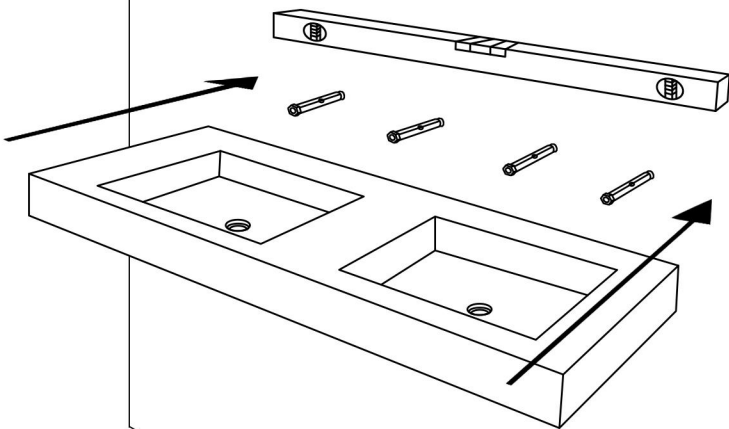

Before fixing the basin in place, ensure that the basin is sitting level.

<4>

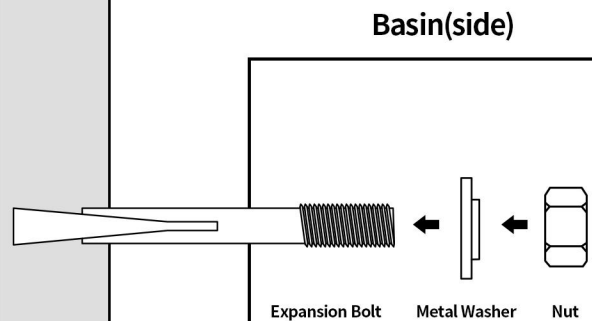

Screw a metal nut onto each fixing bolt to secure the basin.  
**Caution:** do not over tighten as this may damage the basin/top.