

Basin installation Instructions

List:

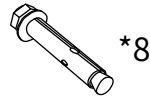
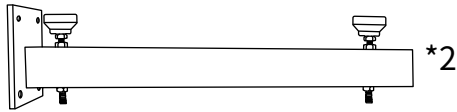
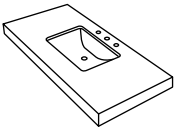

SKU : TOP-C49white

Tools:

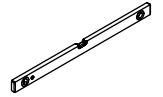
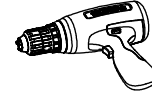
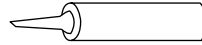
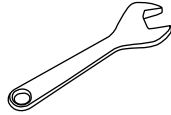
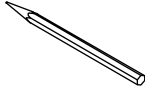

1. Measure the distance of the mounting holes, and the height you want, mark with the pencil.

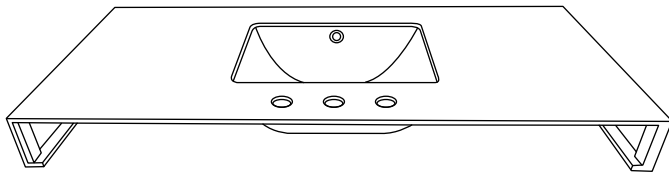

2. Drill holes with a suitable sized drill.

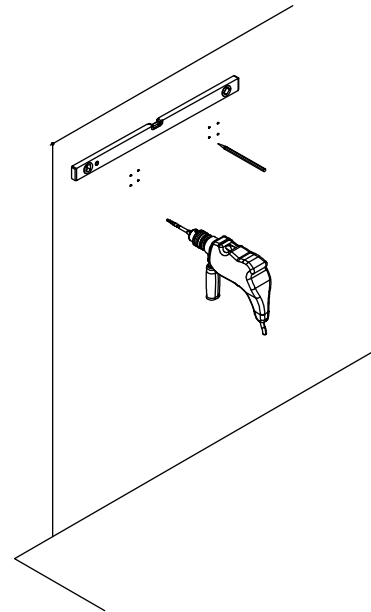

3. Insert the wall plug and mount screws into the wall. Install the brackets. Put some glue on the surface of brackets.

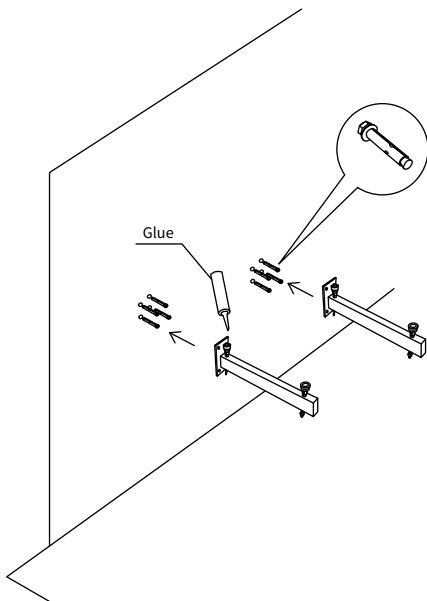

4. Hang the basin on the wall.

