

1. Cut Countertop

- Cut the opening in the countertop by carefully following the traced line

NOTE: Please use the appropriate saw that best fits your countertop material

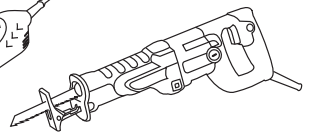
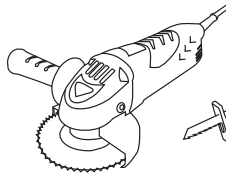
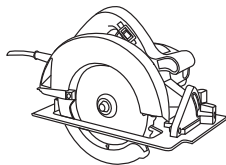
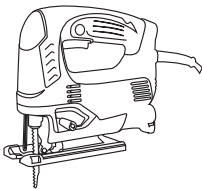
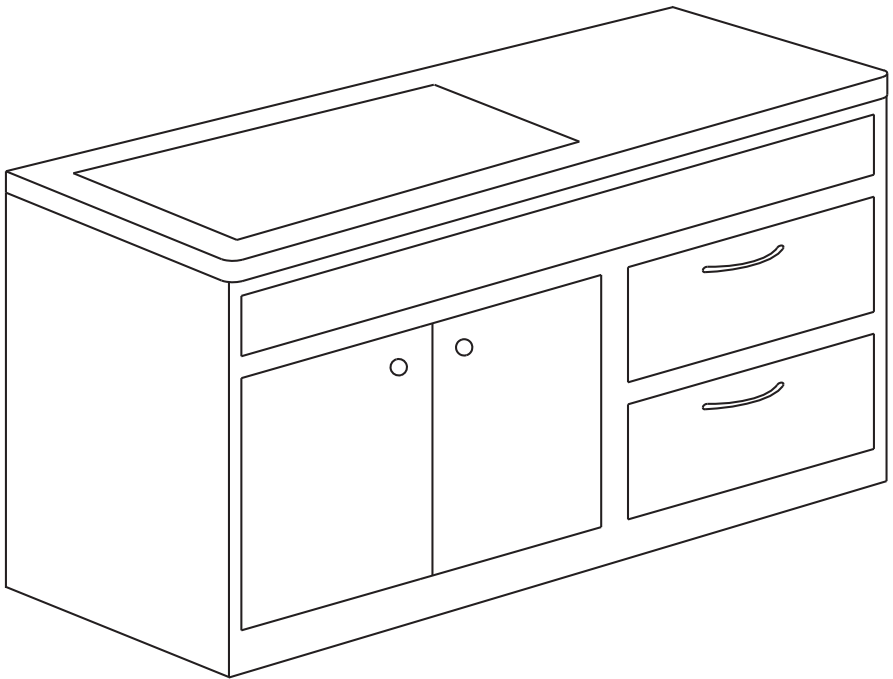

2. Apply Silicone or Plumber's Putty

- Clean and dry the surface around the opening of the sink
- Turn the unit upside down to apply sealant. Apply silicone-based sealant (not included) underneath the edge of the sink

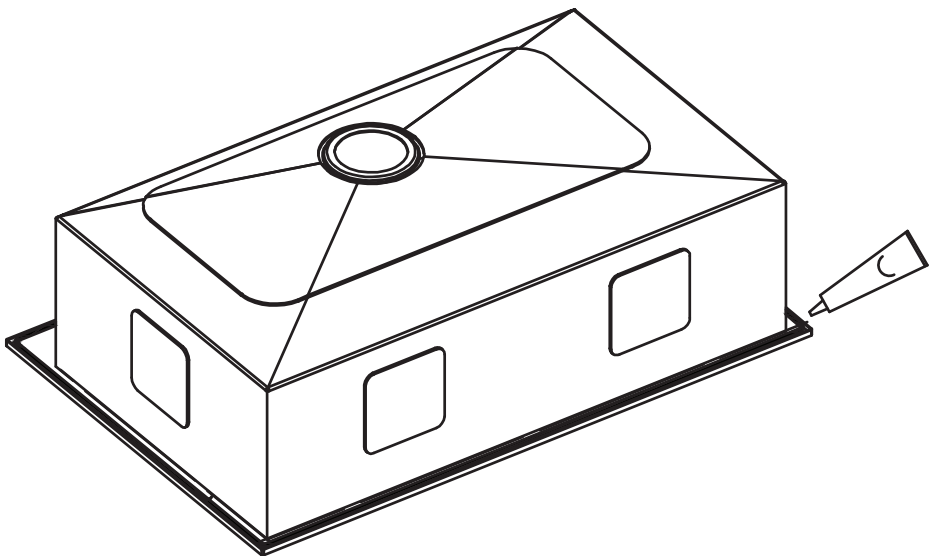

3. Secure Sink to Countertop

- Insert the sink into the opening, check the alignment of the sink to the cutout in the countertop, and press firmly
- Tighten the screws in the front of the sink, followed by the ones in the back and on the sides of the sink
- Remove excess silicone-based sealant
- Allow sealant to set for 30-60 minutes

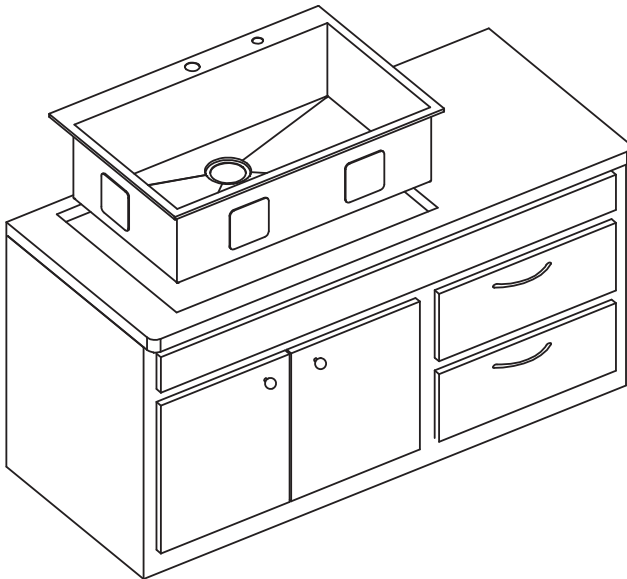

4. Install Plumbing Fixtures

- Connect drain to sink. Connect trap to drain. Connect water supply connections to faucet according to manufacturer's instructions
- Run water into sink and check for leaks

