

# BATHROOM FAUCET

Installation instruction

MB/BN/BG/CH/ORB



## CARE INSTRUCTIONS

Rinse the product with clear water. Dry the product with a soft cloth.

## DO NOT:

Use abrasive cleansers, cloths, or paper towels. Use any cleaning agents containing acid, polish, wax, alcohol, ammonia, bleach, solvent or any other corrosive or harsh chemical cleansers.

## RECOMMENDED TOOLS

Plumber's putty



Thread seal tape



Included



## PRODUCT DRAWING

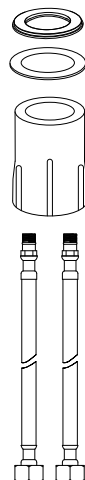
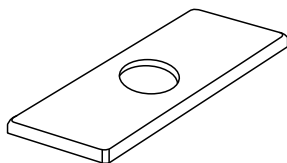
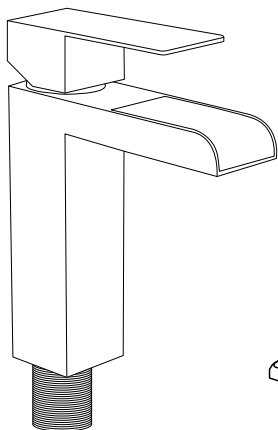

# INSTALLATION STEPS

## BEFORE YOU BEGIN

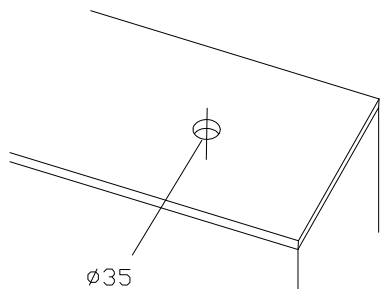

1

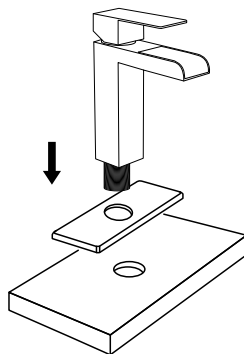

2

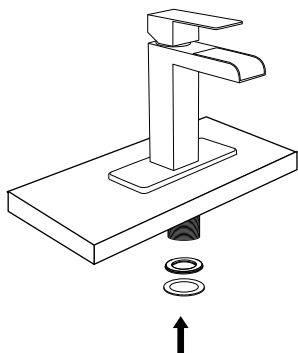

3

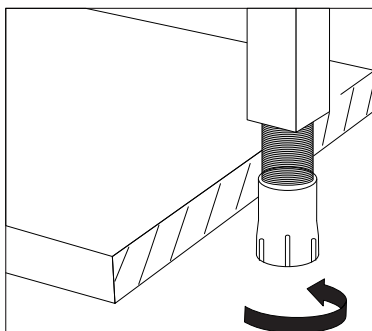

4

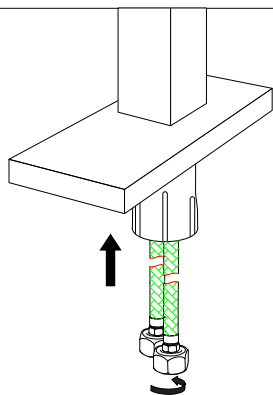

5

