

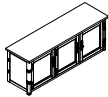



ASSEMBLY INSTRUCTION

MODEL: # FSH2330

Thank you for purchasing this quality product. Be sure to check all packing material carefully for small parts which may have come loose inside the carton during shipment. Separate, identify and count all parts and metal hardware. Compare with parts list to be sure all parts are present. If any part(s) are missing or damaged, please contact your local furniture dealer. For efficient and speedy service, please indicate the model number and code letter of part(s) needed.

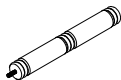
***** Do not fully tighten screws until fully assembled *****

No.	COMPONENT LIST	Q'ty	No.	HARDWARE LIST	Q'ty
(A)	 Side Table Frame	1pc	(C)	 Shelf	1pc
(B)	 Legs	4pcs	(D)	 Stand legs	4pcs

Step 1 : Align and place Legs (B) into Side table frame (A) then rotate clockwise.

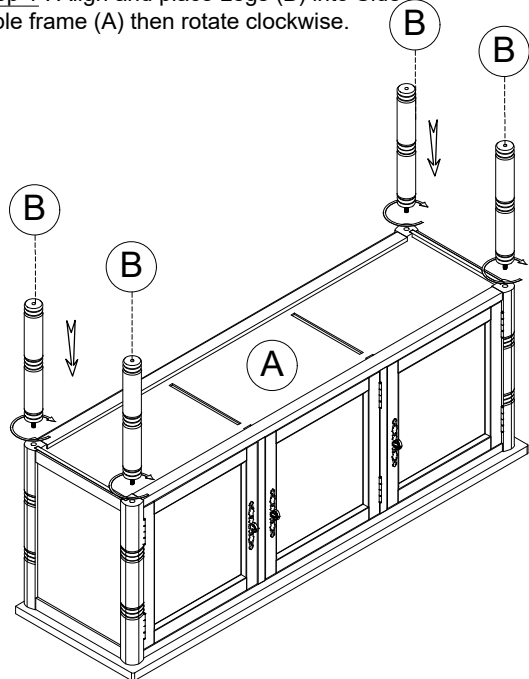

Step 2 : Align and place Shelves (c) into legs (B) and put stand leg (D) then rotate clockwise.

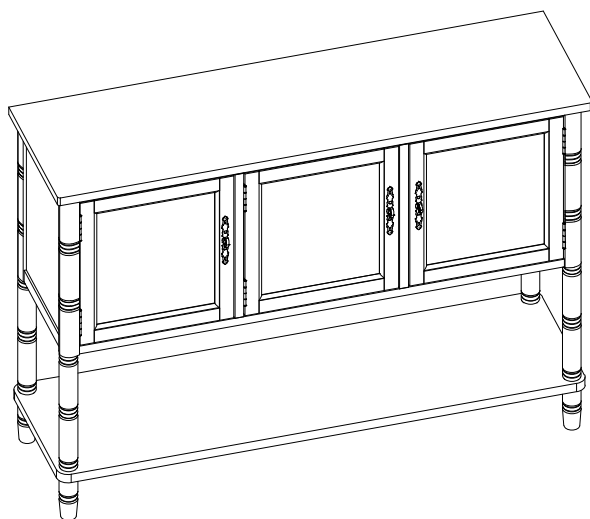
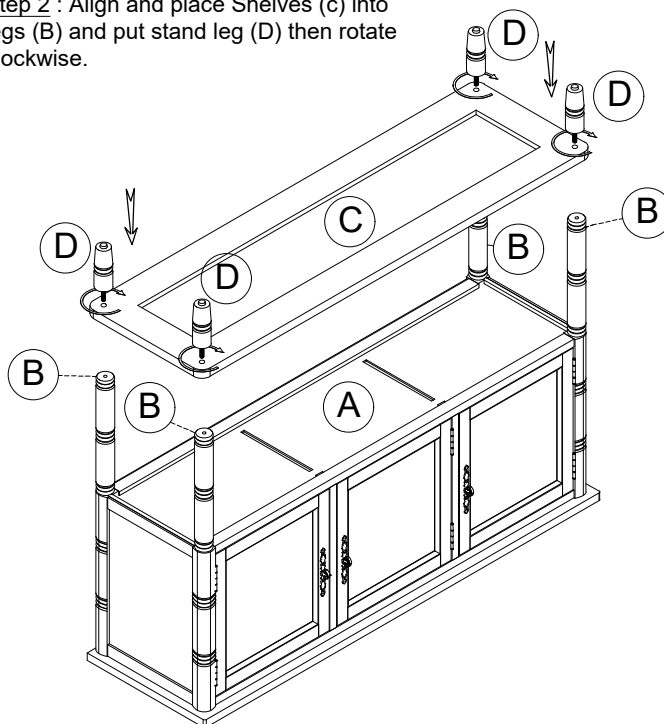

**FINISH .
THANK YOU !**