

ASSEMBLY INSTRUCTIONS

36 INCH BATH VANITY-CABINET

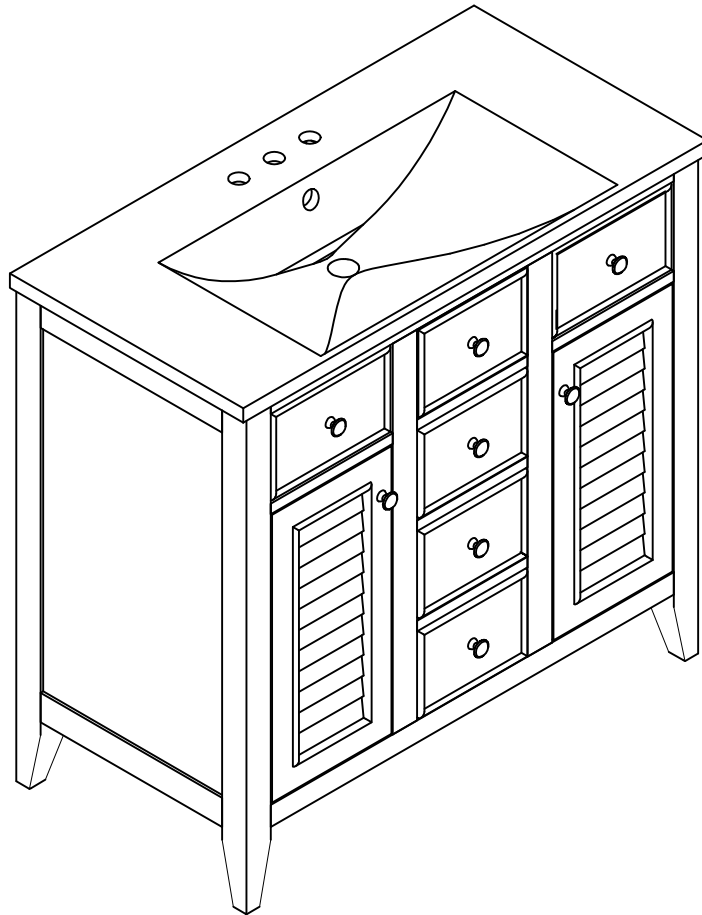

Thank you for purchasing this quality product. Be sure to check all packing material carefully for small parts which may have come loose inside the carton during shipment. Separate, identify and count all parts and hardware. Compare with the parts list to be sure all parts are present.
"DO NOT TIGHTEN SCREWS UNTIL COMPLETELY ASSEMBLED"

*** Use of power tool to assemble this product will invalidate any claim and damage this product making unsafe !!!**
*** Please assemble on a clean soft surface to avoid damage.**

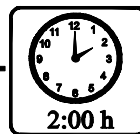
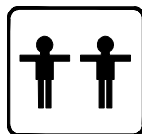

Tools Required

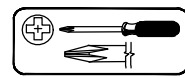

(Not included)

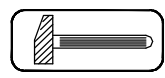

(Not included)

IMPORTANT:

PLEASE READ INSTRUCTION BEFORE STARTING THE ASSEMBLY

Thank you for buying our products.

Please read the installation manual carefully before installation,

we need you to follow the instructions on the accessories and hardware

step by step assembly complete, our instructions are very detailed.

Products are environmentally friendly products,

Please rest assured that you do not soak in water, do not place very heavy items,

do not malicious push and pull,

if you have any problems in the process of assembly and use, please contact us.

Thank you again for your purchase of our products,

I wish you a happy life.

Detail View - CABINET

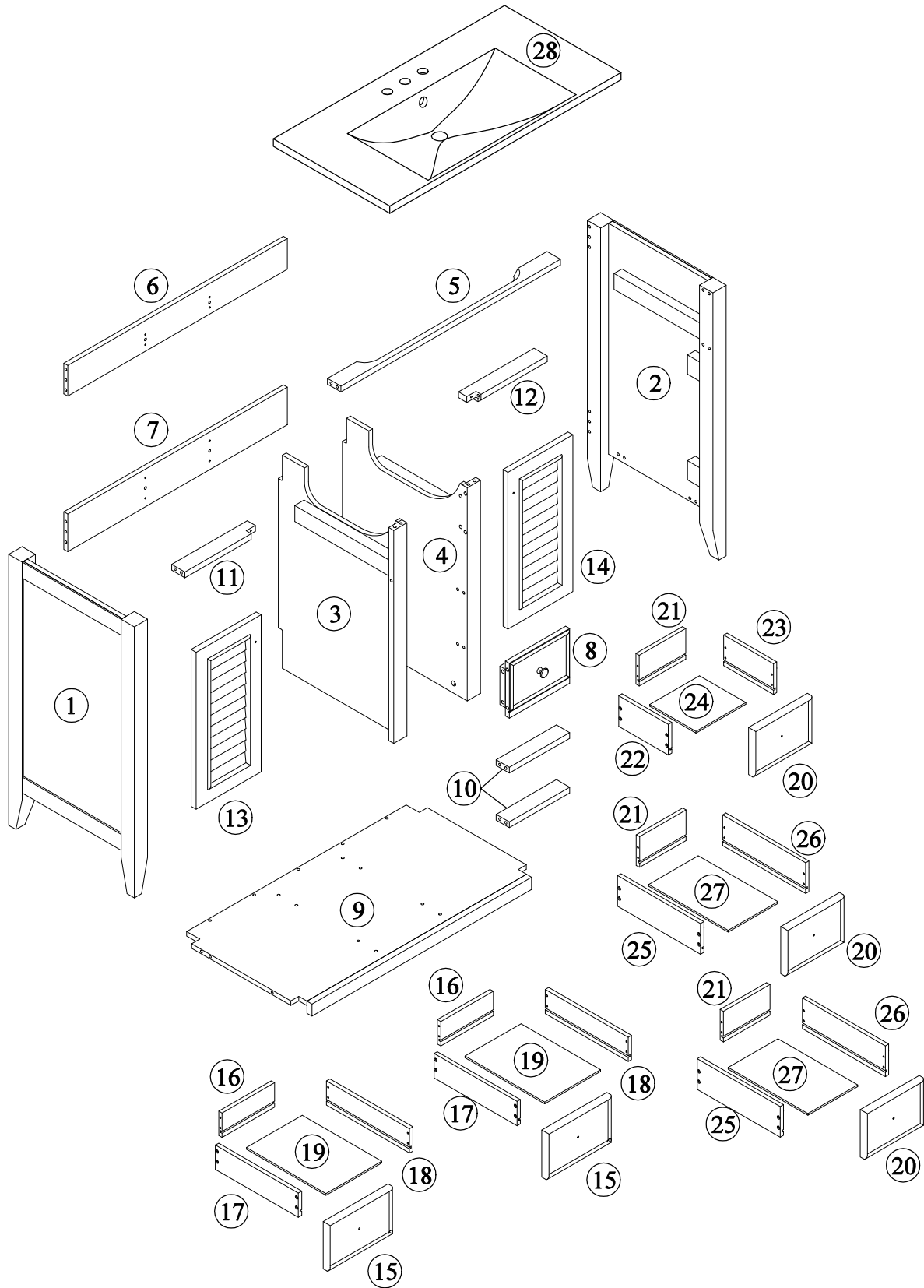

Identifying the Hardware-Identify the hardware using the illustrations below.



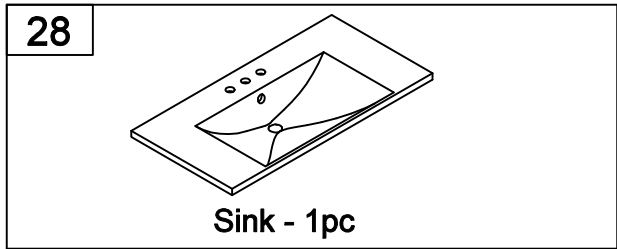

Part List - WF299663

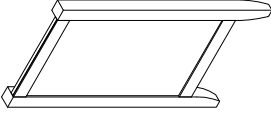
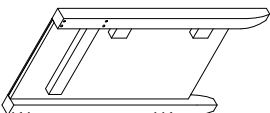
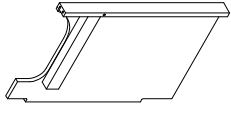
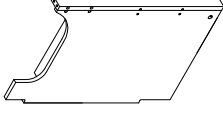
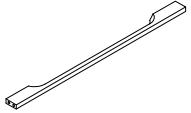
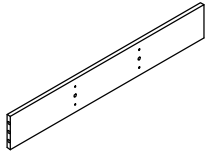
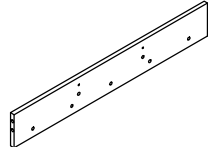
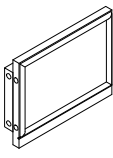
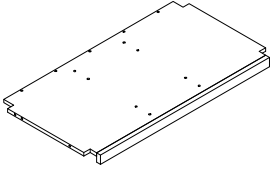
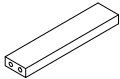

Part List - WF299664

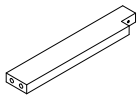
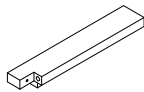
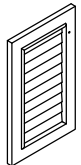
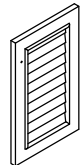
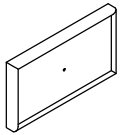
1		2	
Side Panel (L) - 1pc		Side Panel (R) - 1pc	
3		4	
Mid Fixed Panel (L) - 1pc		Mid Fixed Panel (R)- 1pc	
5		6	
Top Crossbar - 1pc		Back Panel Top - 1pc	
7		8	
Back Panel Bottom - 1pc		Fake drawer - 1pc	
9		10	
Mid Fixed Panel - 1pc		Mid Crossbar - 2pcs	

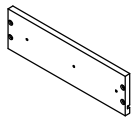
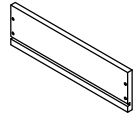
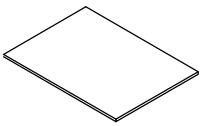
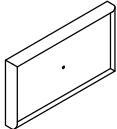

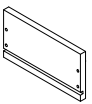
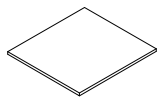



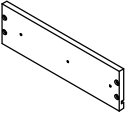
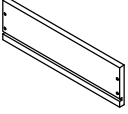
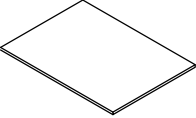

Part List - WF299664

<p>11</p>  <p>Mid Crossbar (L) - 1pc</p>	<p>12</p>  <p>Mid Crossbar (R) - 1pc</p>
<p>13</p>  <p>Door (L) - 1pc</p>	<p>14</p>  <p>Door (R) - 1pc</p>
<p>15</p>  <p>Top Drawer Front - 2pcs</p>	<p>16</p>  <p>Top Drawer Back - 2pcs</p>
<p>17</p>  <p>Top Drawer Side (L) - 2pcs</p>	<p>18</p>  <p>Top Drawer Side (R) - 2pcs</p>
<p>19</p>  <p>Top Drawer Bottom - 2pcs</p>	<p>20</p>  <p>Mid Drawer Front - 3pcs</p>
<p>21</p>  <p>Mid Drawer Back - 3pcs</p>	<p>22</p>  <p>Mid Drawer Top Side (L) - 1pc</p>
<p>23</p>  <p>Mid Drawer Top Side (R) - 1pc</p>	<p>24</p>  <p>Mid Drawer Bottom 1- 1pc</p>

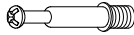
Part List - WF299664

<p>25</p>  <p>Mid Drawer Bottom Side (L) - 2pcs</p>	<p>26</p>  <p>Mid Drawer Bottom Side (R) -2pcs</p>
<p>27</p>  <p>Mid Drawer Bottom 2 - 2pcs</p>	

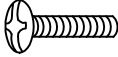
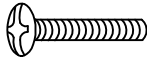
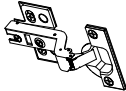
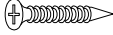
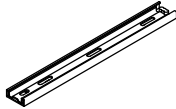
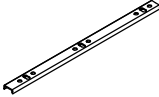
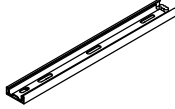
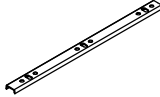
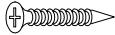
Hardware List - WF299664

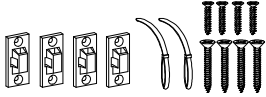
<p>A</p>  <p>ø13x1/4"x30mm</p>	<p>B</p>  <p>ø1/4"x16x1mm</p>	<p>C</p>  <p>ø6x35mm</p>
<p>Hex-Head bolts - 4pcs Washer - 4pcs Three in one bolts - 29pcs</p>		
<p>D</p>  <p>ø14.5x12mm</p>	<p>E</p>  <p>ø8xø4x25mm</p>	<p>F</p>  <p>ø8xø4x32mm</p>
<p>Three in one lock - 29pcs Round head screw - 8pcs Round head screw - 42pcs</p>		
<p>G</p> 	<p>H</p>  <p>ø5/32"x20mm</p>	<p>J</p>  <p>ø5/32"x32mm</p>
<p>Handle - 8pcs Handle screw - 3pcs Handle screw - 5pcs</p>		
<p>K</p> 	<p>L</p>  <p>ø7xø3.5x15mm</p>	<p>M</p>  <p>ø300x35mm</p>
<p>Damping hinge - 4pcs Flat head screw - 24pcs Slide rails - 8pcs</p>		
<p>N</p>  <p>ø298x18mm</p>	<p>O</p>  <p>ø200x35mm</p>	<p>P</p>  <p>ø198x18mm</p>
<p>Slide rails - 8pcs Slide rails - 2pcs Slide rails - 2pcs</p>		
<p>Q</p>  <p>ø6xø3x12mm</p>	<p>R</p>  <p>ø8x30mm</p>	<p>S</p>  <p>4mm</p>
<p>Flat head screw - 60pcs Wood dowel - 34pcs Allen key - 1pc</p>		
<p>T</p>  <p>Anti fall hardware - 1set</p>		

STEP: 1

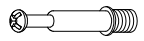

C

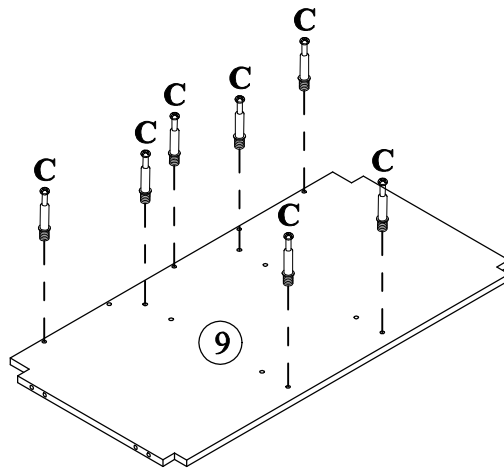
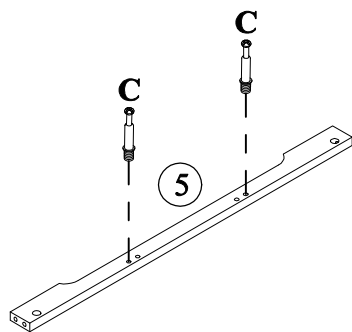
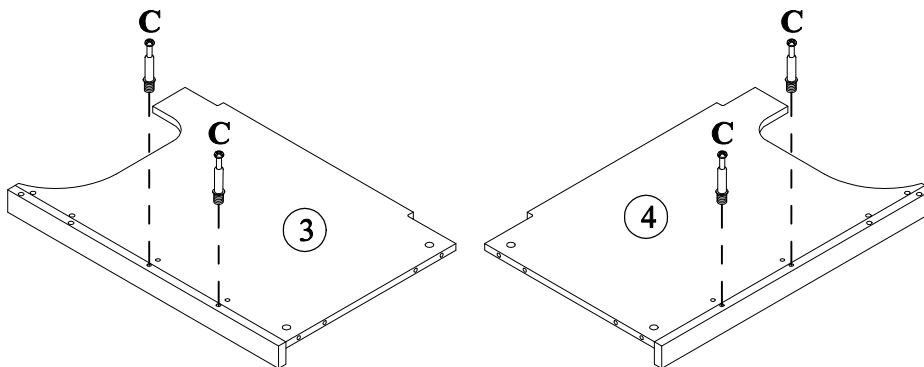
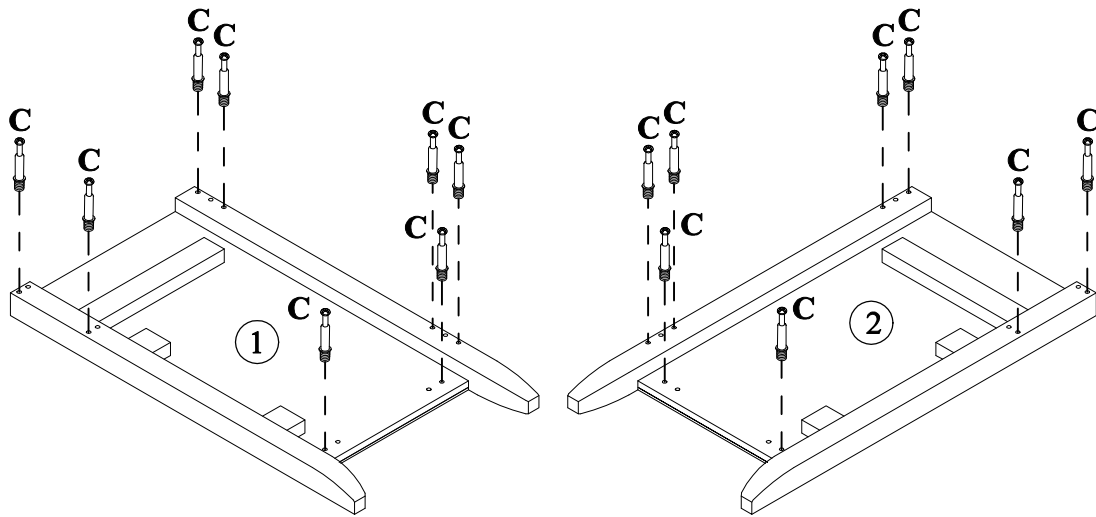

29PCS



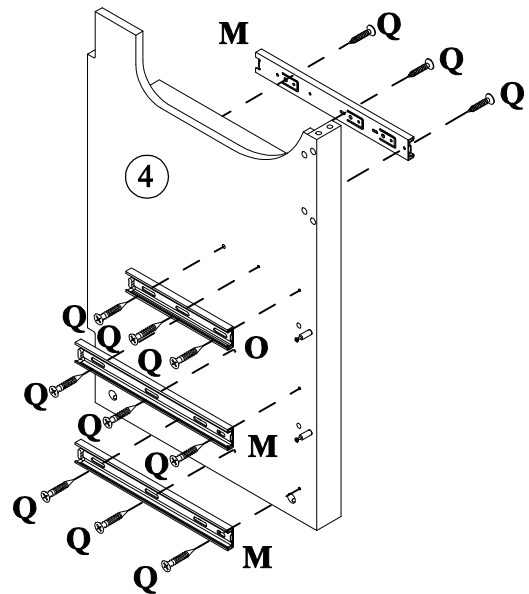
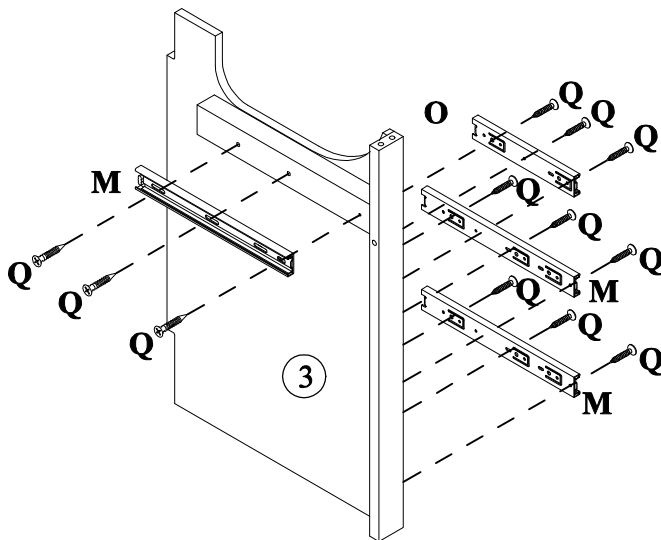
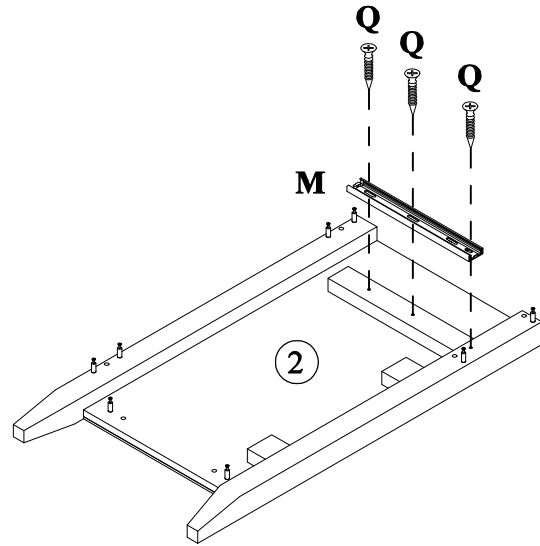
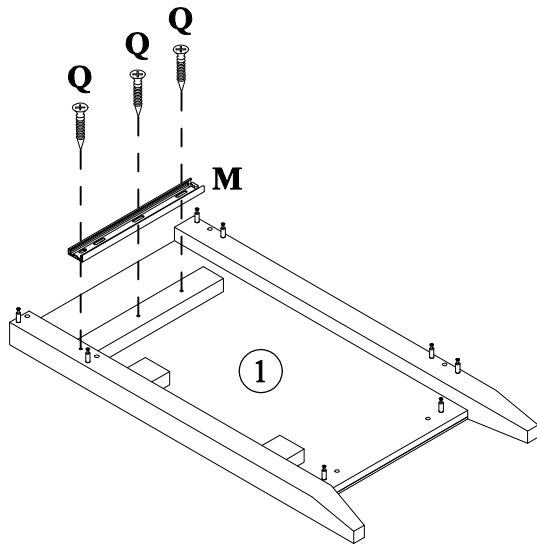

STEP: 2

M		O		Q	
8PCS		2PCS		30PCS	

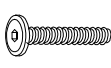

STEP: 3

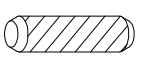
A	B	D	R
			
4PCS	4PCS	4PCS	8PCS

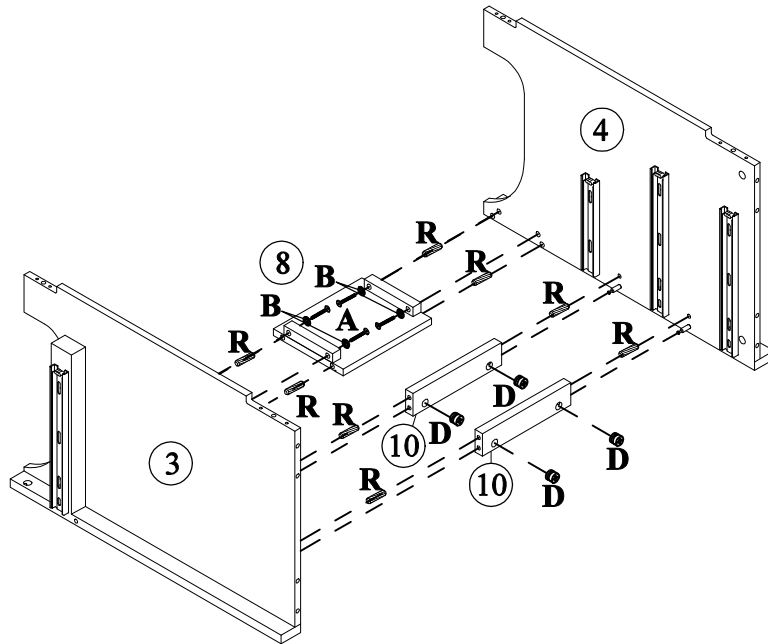

STEP: 4

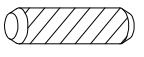
E	R
	
8PCS	4PCS

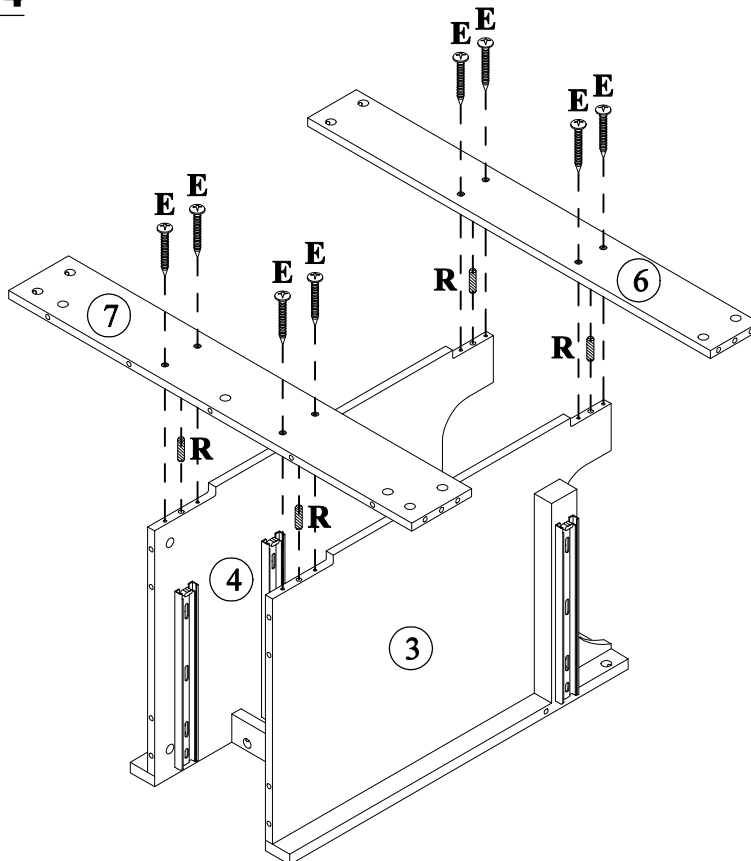

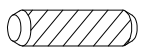

STEP: 5

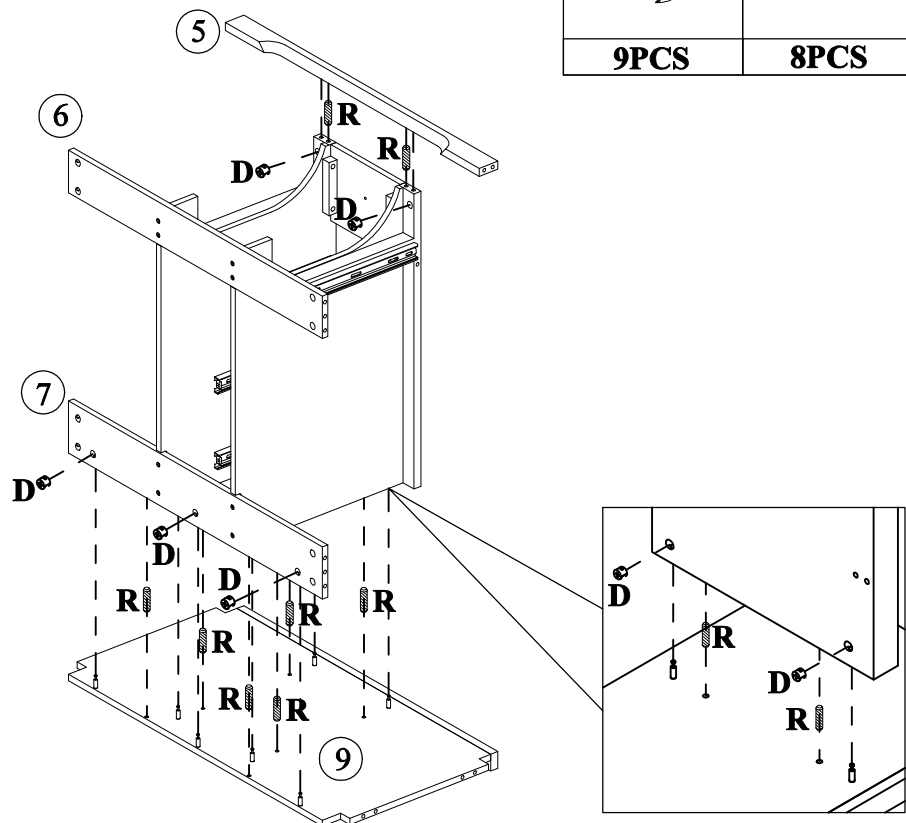
D		R	
	9PCS		8PCS



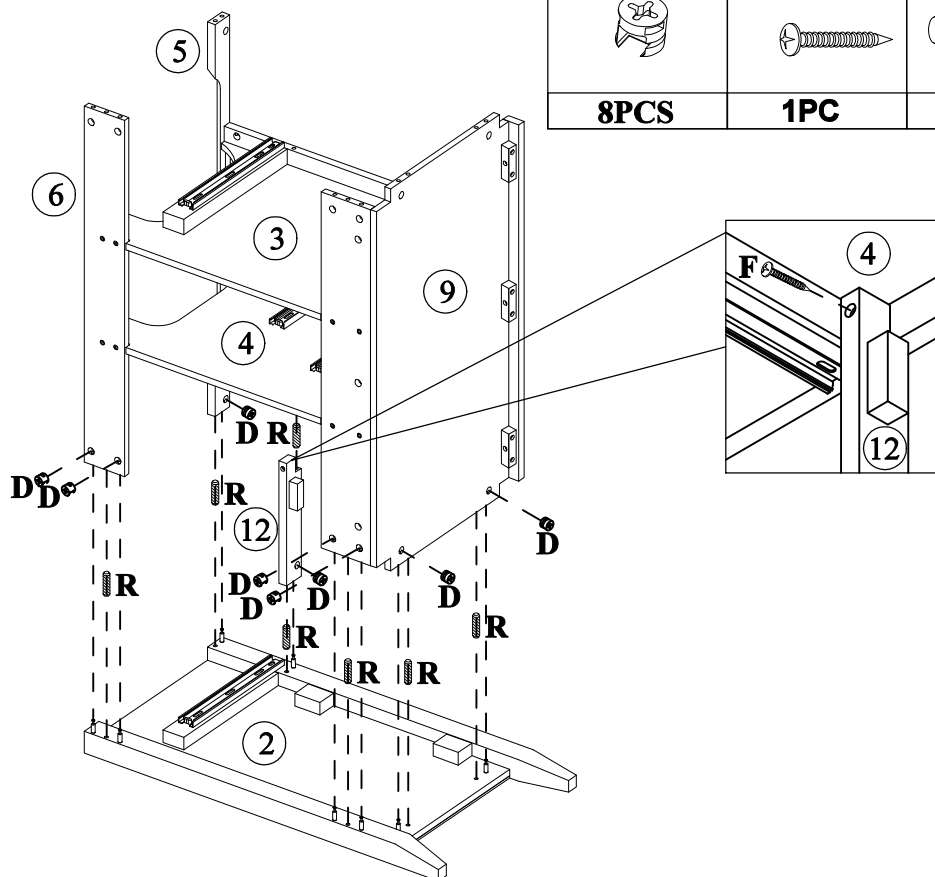

STEP: 6

D		F		R	
	8PCS		1PC		7PCS



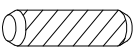

STEP: 7

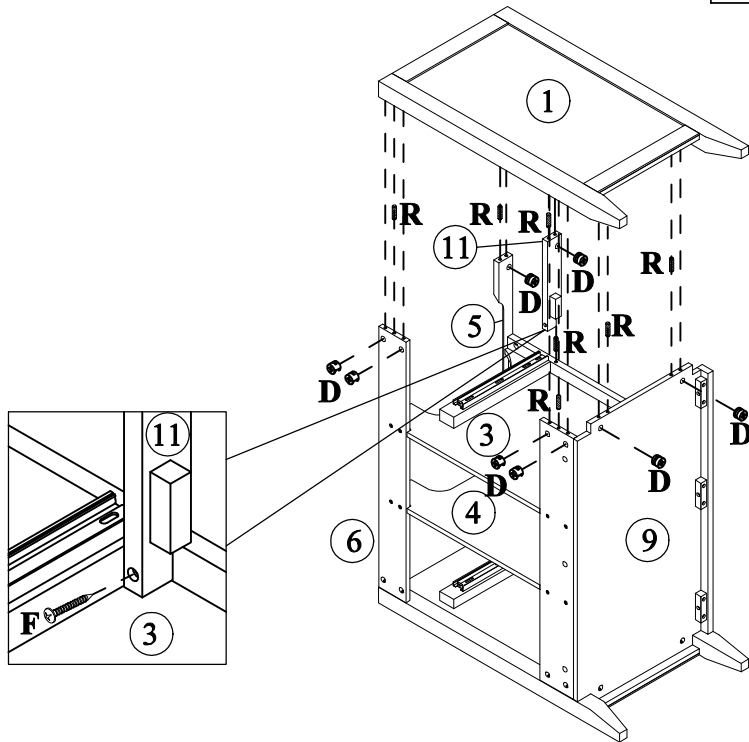
D		F		R	
8PCS		1PC		7PCS	



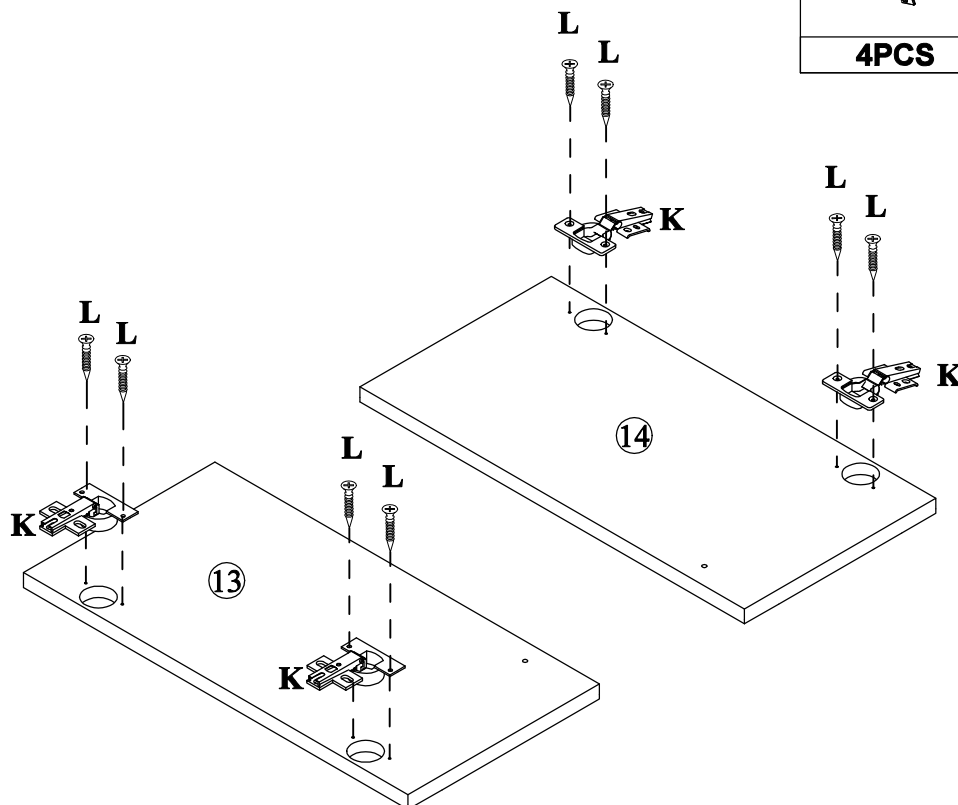

STEP: 8

K		L	
4PCS		8PCS	



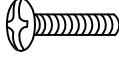

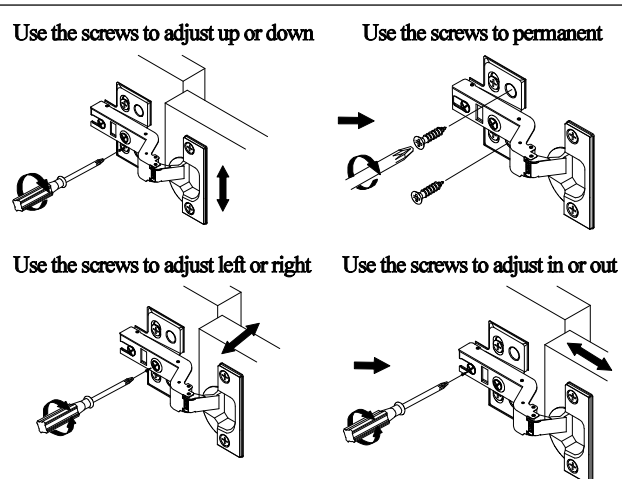
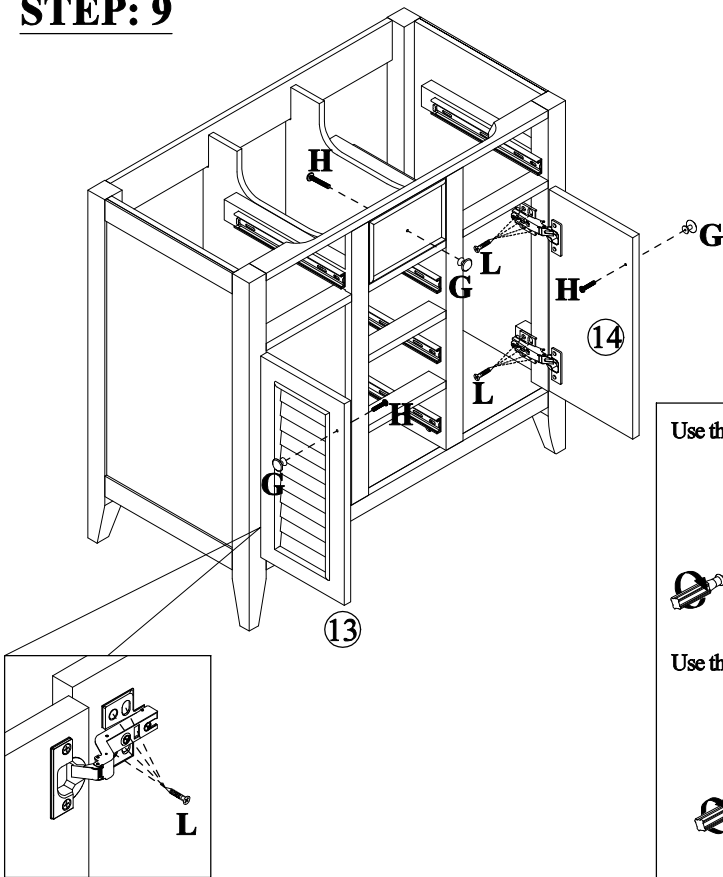

STEP: 9

G		H		L	
3PCS		3PCS		16PCS	

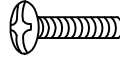
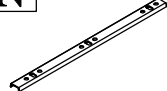

STEP: 10

F	G	J	N	Q
				
16PCS	2PCS	2PCS	4PCS	12PCS

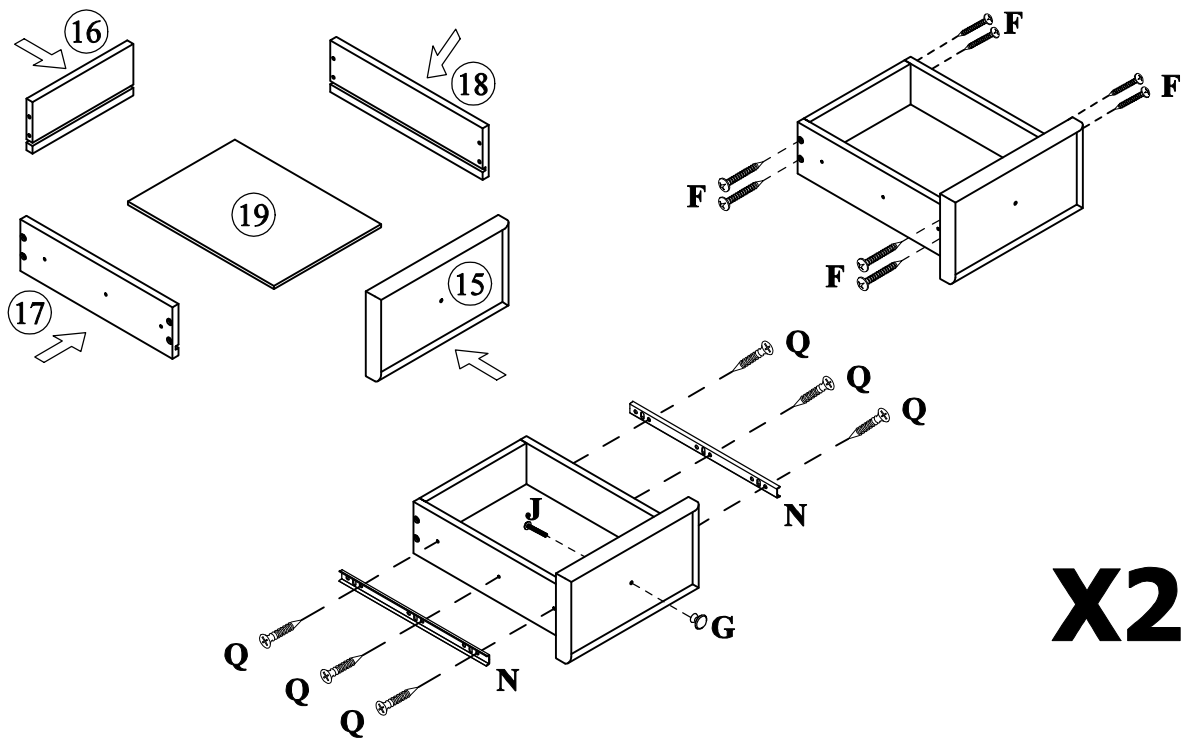



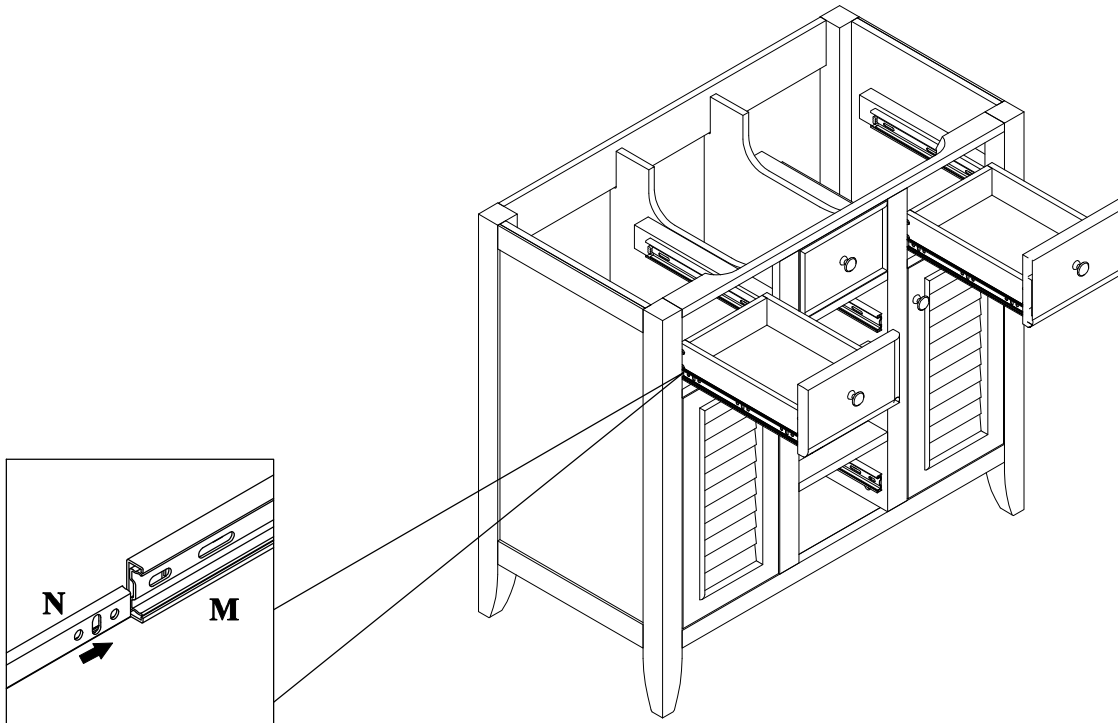

X2

STEP: 11

The structure of the cabinet is quite stable, if you are not sure, you can use anti-falling hardware



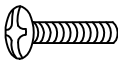
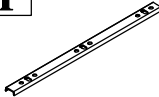

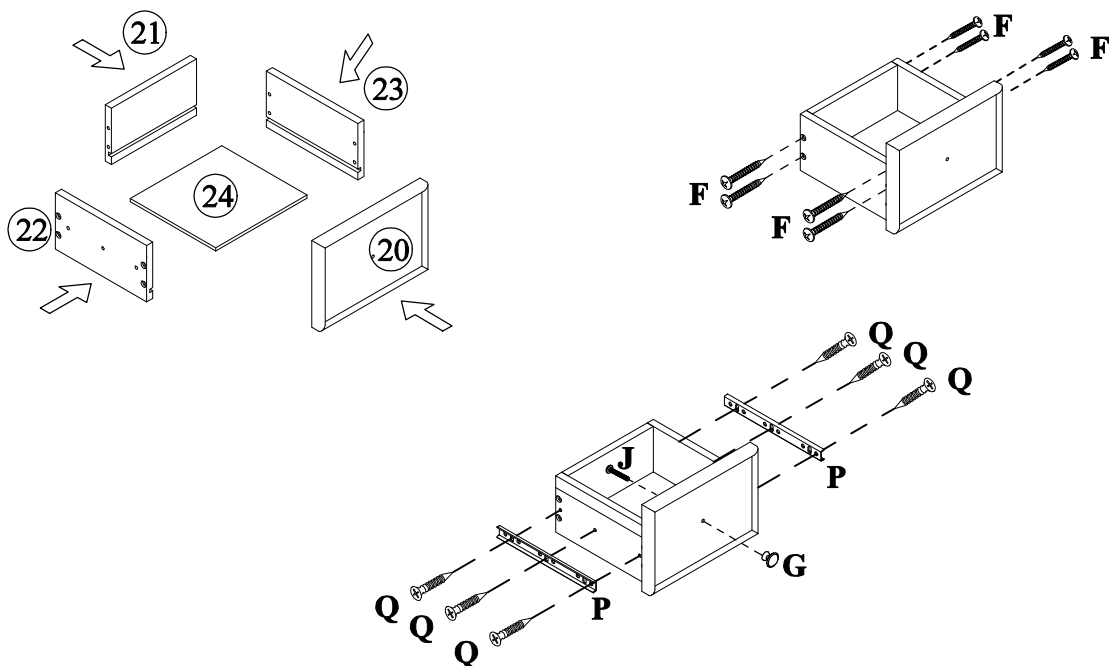

STEP: 12

F	G	J	P	Q
				
8PCS	1PC	1PC	2PCS	6PCS

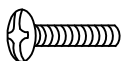
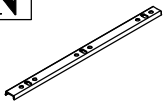

STEP: 13

F 	G 	J 	N 	Q 
16PCS	2PCS	2PCS	4PCS	12PCS

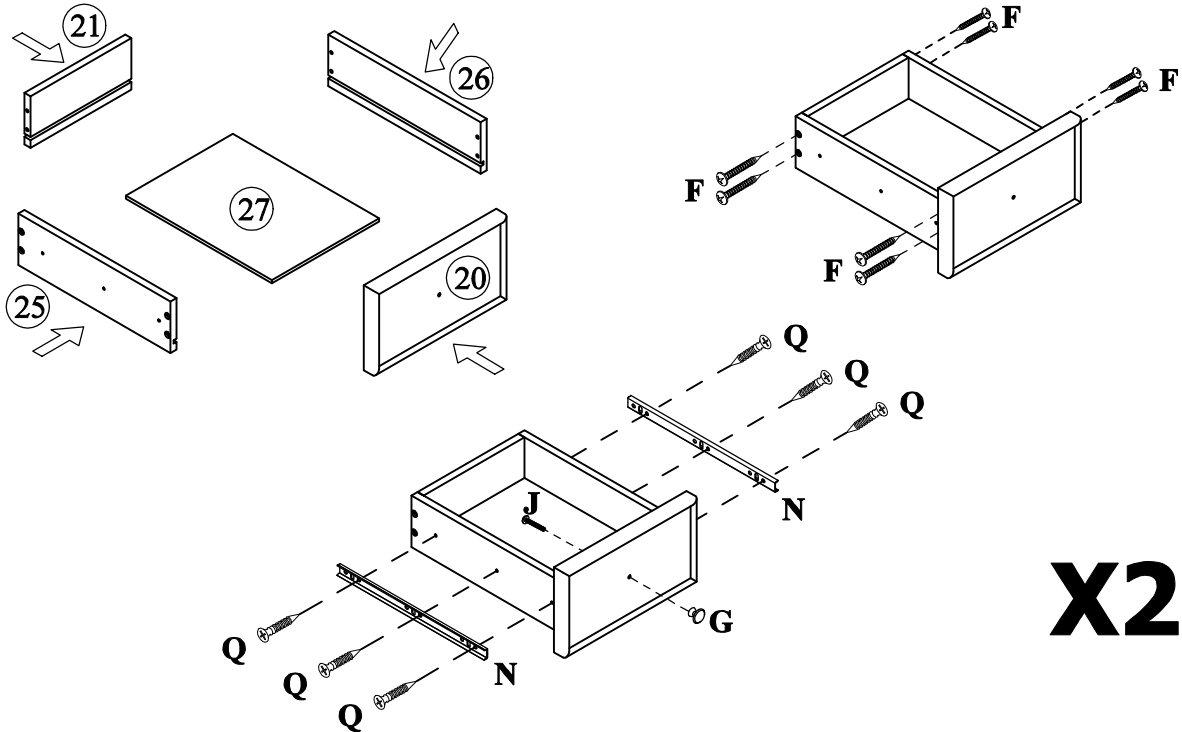

STEP: 14

Install the sink on the cabinet with glue.
Let stand for 24 hours

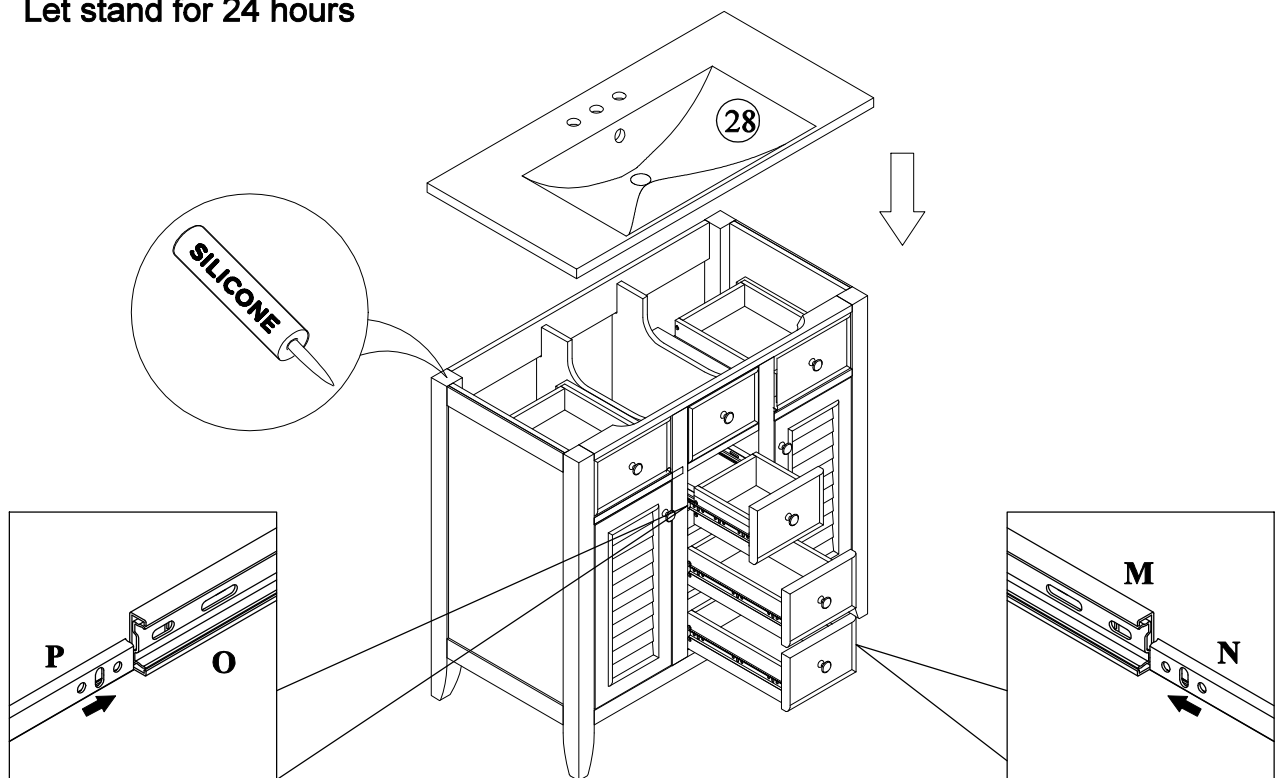

STEP: 15

