

ASSEMBLY INSTRUCTION

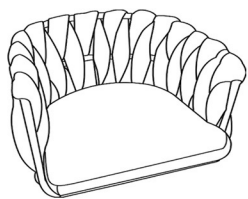

A*1

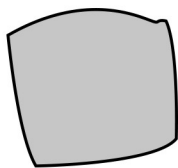

B*1

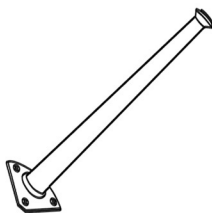

C*2



D*2

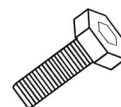

E*13

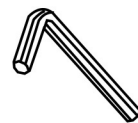

F*1

1

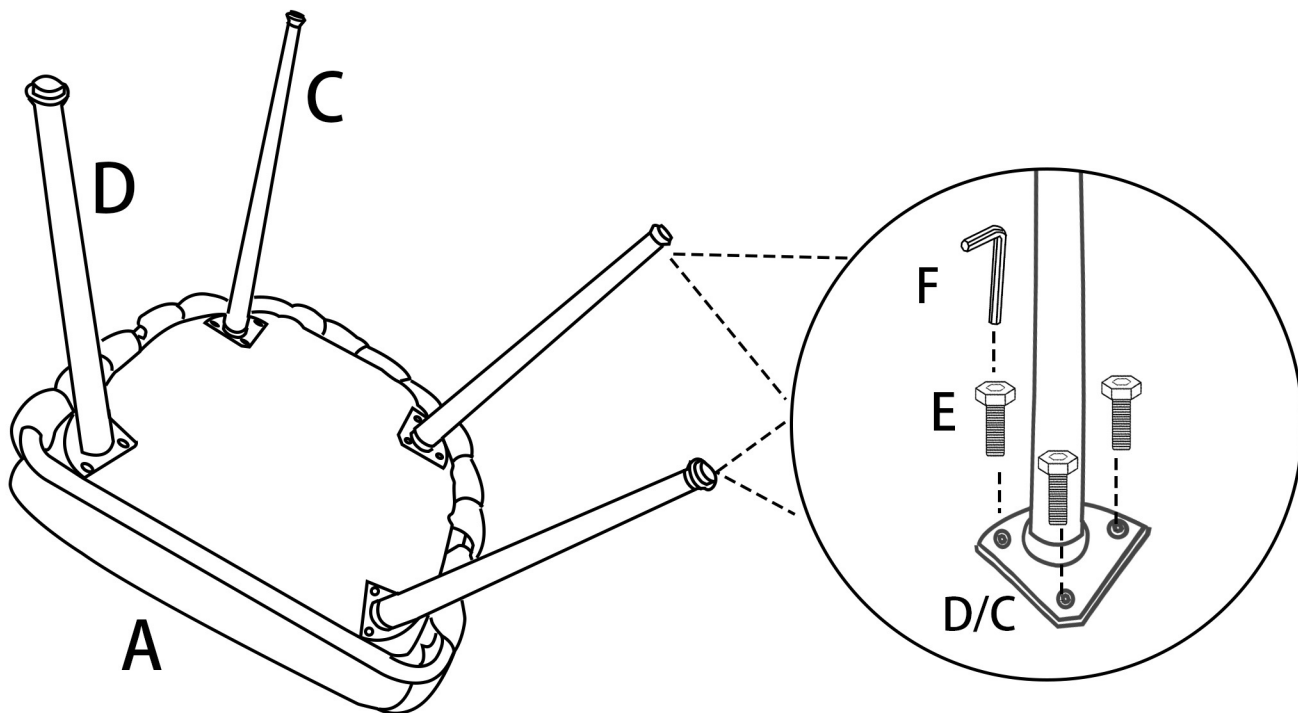

2

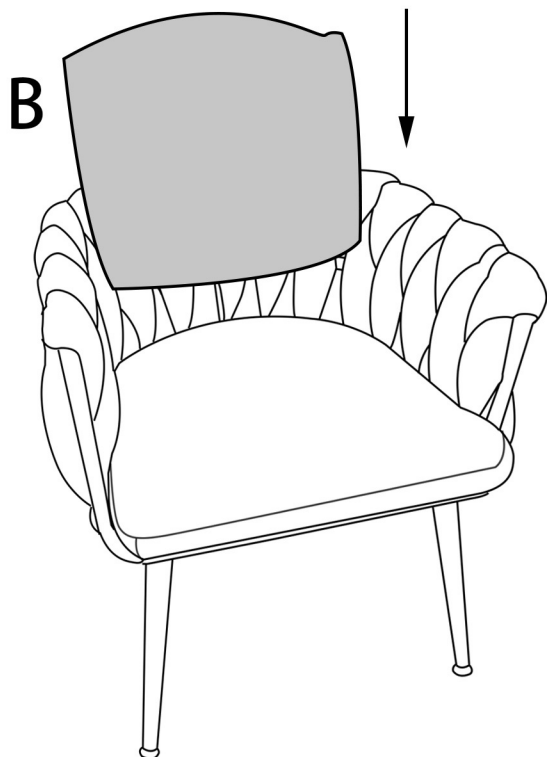

3

