

ASSEMBLY INSTRUCTION

STEP1

STEP2

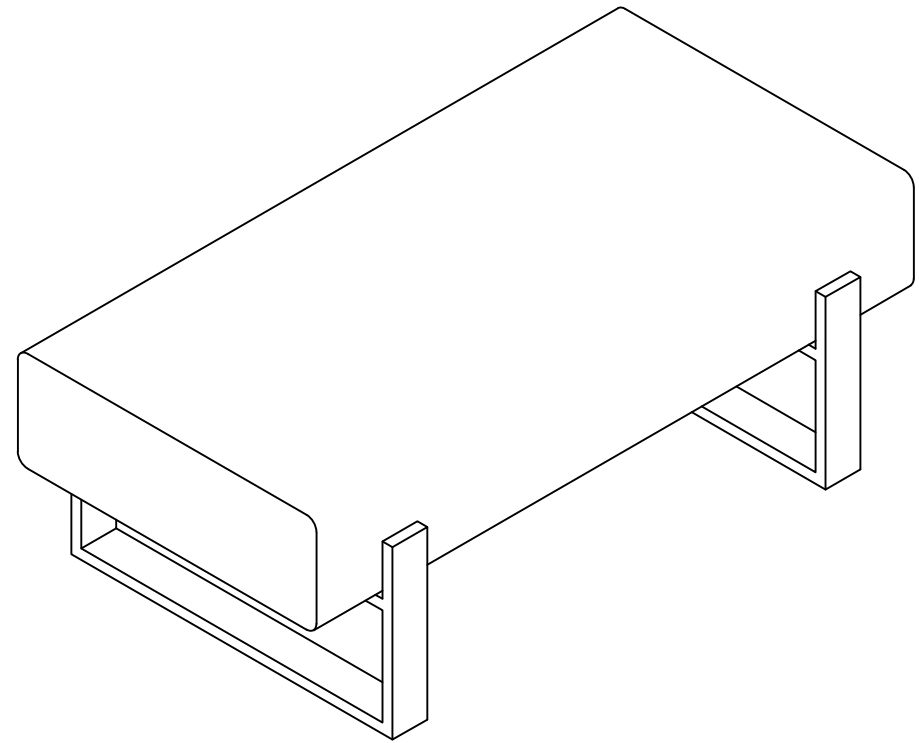
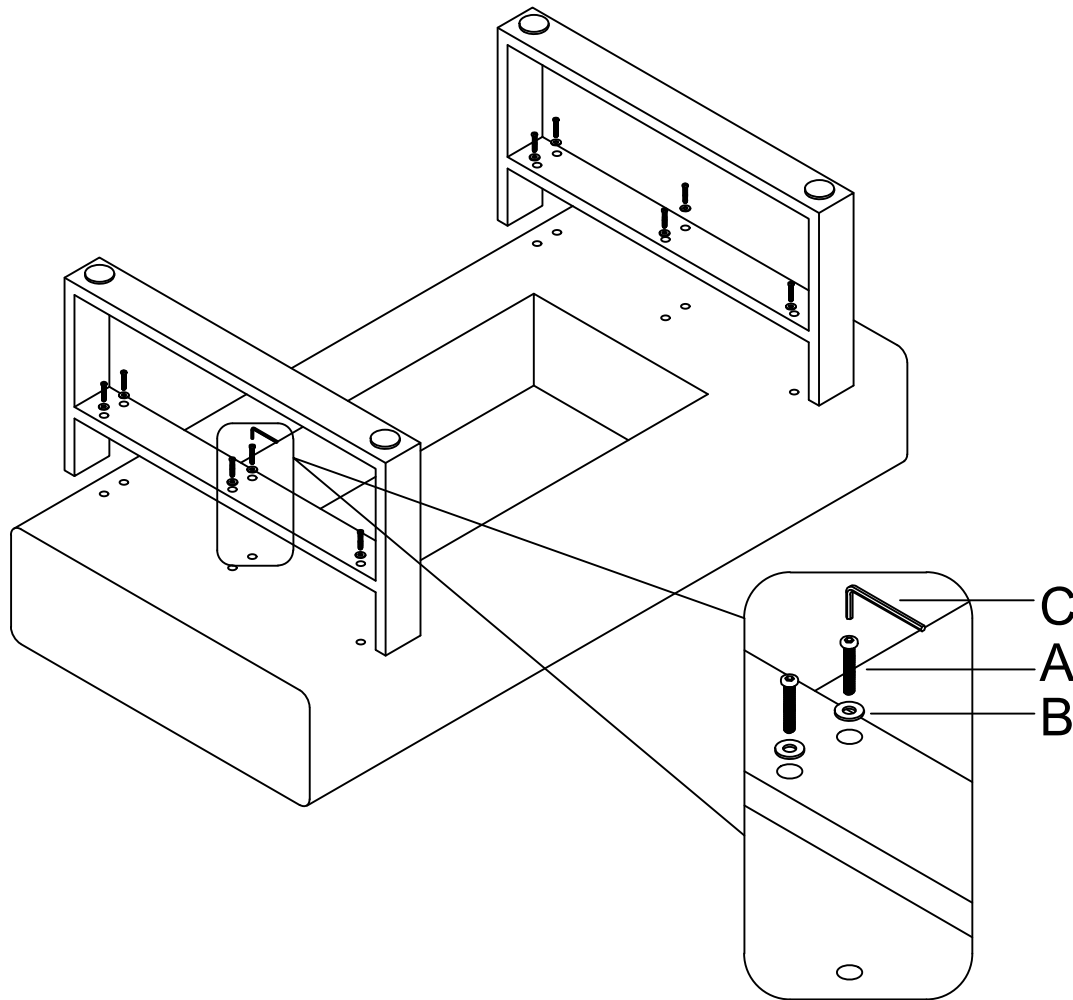

DI-68

A



M8*40mm 12pcs

B



12pcs

C



1pc