

HULALA

H O M E

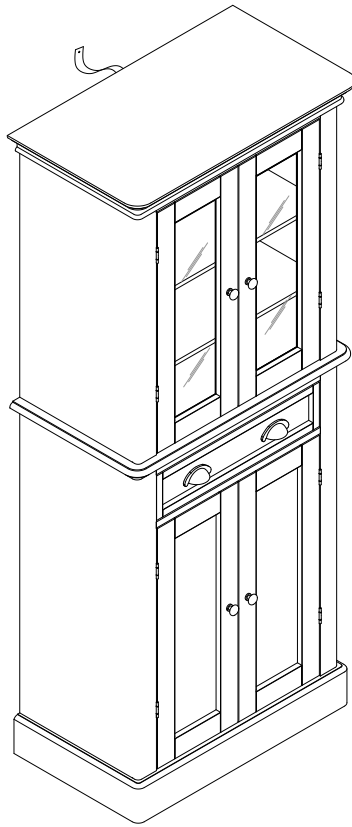

ITEM NO.KPJY0536

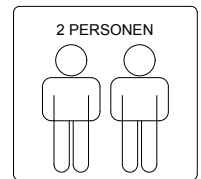

NOTE:

This brochure contains IMPORTANT safty info. Please read and keep for future reference.

MAINTAINANCE

AND WARNING

- Keep furniture away from heat.
- Do not clean furniture with harsh cleansers or polish. Do not use detergents, Solvents, abrasives, spray packs or leather cleaner. Use non-color mild soap with warm water clean spills(Mix 1:10 soap to water)
- Do not place furniture under direct sunlight, material will possibly fade over time.
- Do not use on site dry Cleaning machine.
- Children should not climb or jump on the furniture.
- Do not write on furniture without a padded barrier to protect the surface.
- Not for commercial use, For residential use only.

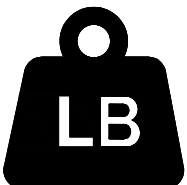

Weight Limitation

100LBS



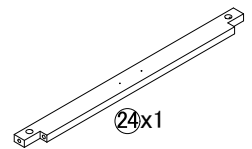
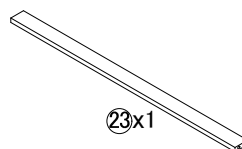
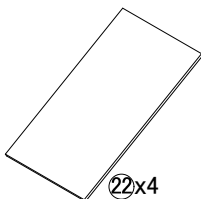
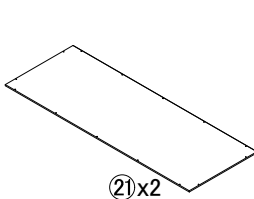
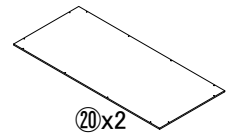
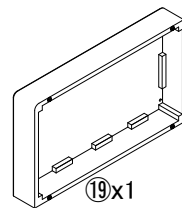
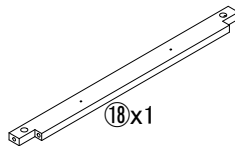
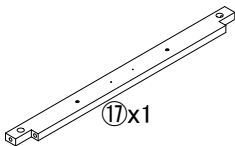
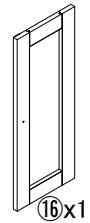
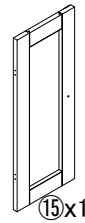
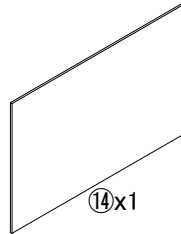
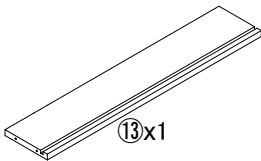
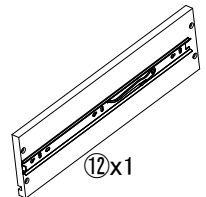
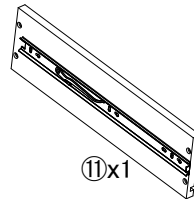
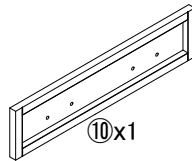
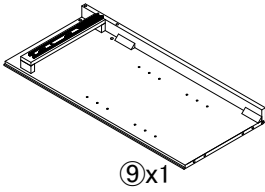
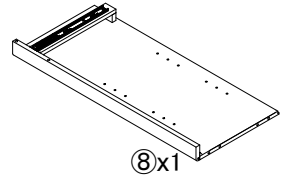
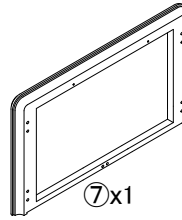
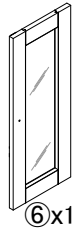
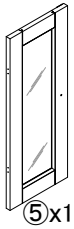
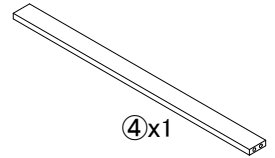
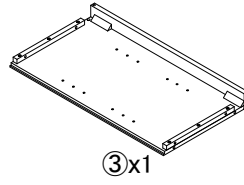
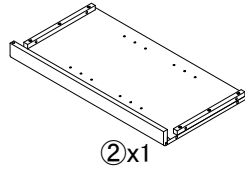
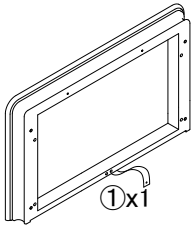

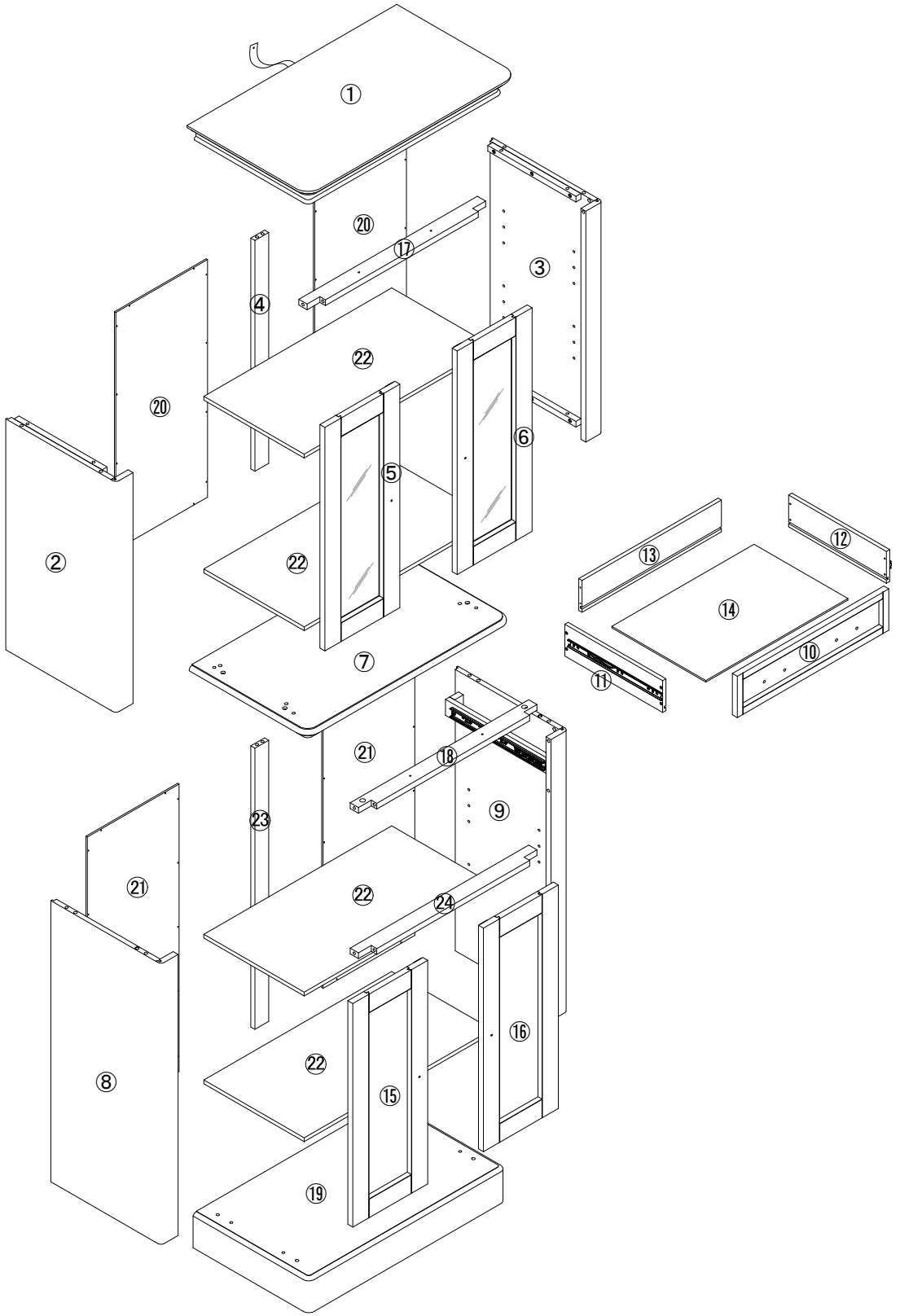









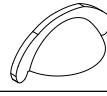





PARTS LIST















OVERVIEW

HARDWARE LIST

| | | | | | | | | | | | | | | | |
|---|-----|---|-----|---|-----|---|-----|---|----|---|-----|---|----|---|-----|
| A | x6 | B | x6 | C | x16 | D | x30 | E | x2 | F | x4 | G | x4 | H | x12 |
|  | |  | |  | |  | |  | |  | |  | |  | |
| Ø6*30mm | | Ø15*9mm | | Ø1/4*1" | | Ø8*30mm | | | | | | Ø5/32*3/4" | | Ø4*28mm | |
| I | x52 | J | x32 | K | x2 | L | x4 | M | x8 | N | x16 | O | x1 | P | x1 |
|  | |  | |  | |  | |  | |  | |  | |  | |
| Ø3*16mm | | Ø3*16mm | | | | Ø3*16mm | | | | | | M4 | | Ø4*38mm | |
| Q | x1 | R | x1 | S | x4 | T | x1 | | | | | | | | |
|  | |  | |  | |  | | | | | | | | | |
| | | | | Ø5/32*5/8" | | M4 | | | | | | | | | |

SPARE

| | | | | | | | | | | | | | | | |
|---|----|---|----|---|----|---|----|---|----|---|----|---|----|---|----|
| A | x1 | B | x1 | C | x1 | D | x1 | G | x1 | H | x1 | I | x1 | J | x1 |
|  | |  | |  | |  | |  | |  | |  | |  | |
| Ø6*30mm | | Ø15*9mm | | Ø1/4*1" | | Ø8*30mm | | Ø5/32*3/4" | | Ø4*28mm | | Ø3*16mm | | Ø3*16mm | |
| L | x1 | N | x1 | S | x1 | | | | | | | | | | |
|  | |  | |  | | | | | | | | | | | |
| Ø3*16mm | | | | Ø5/32*5/8" | | | | | | | | | | | |



Be sure to check all packing material carefully for small parts, which may have come loose inside the carton during shipment.

ASSEMBLY INSTRUCTIONS

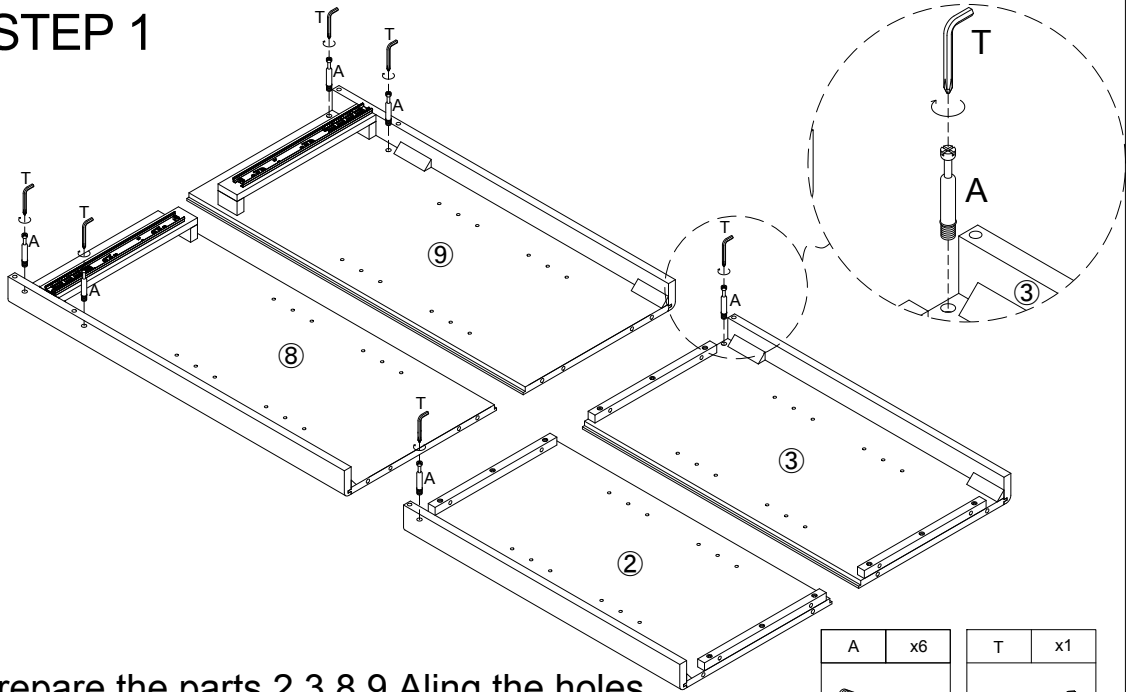
STEP 1







Prepare the parts 2,3,8,9. Align the holes in 2,3,8,9 as picture show, screw in the Cam Bolt A into the hole and tighten by Allenkey T.

| | | | |
|--|----|---|----|
| A | x6 | T | x1 |
|  | |  | |
| Ø6*30mm | | M4 | |

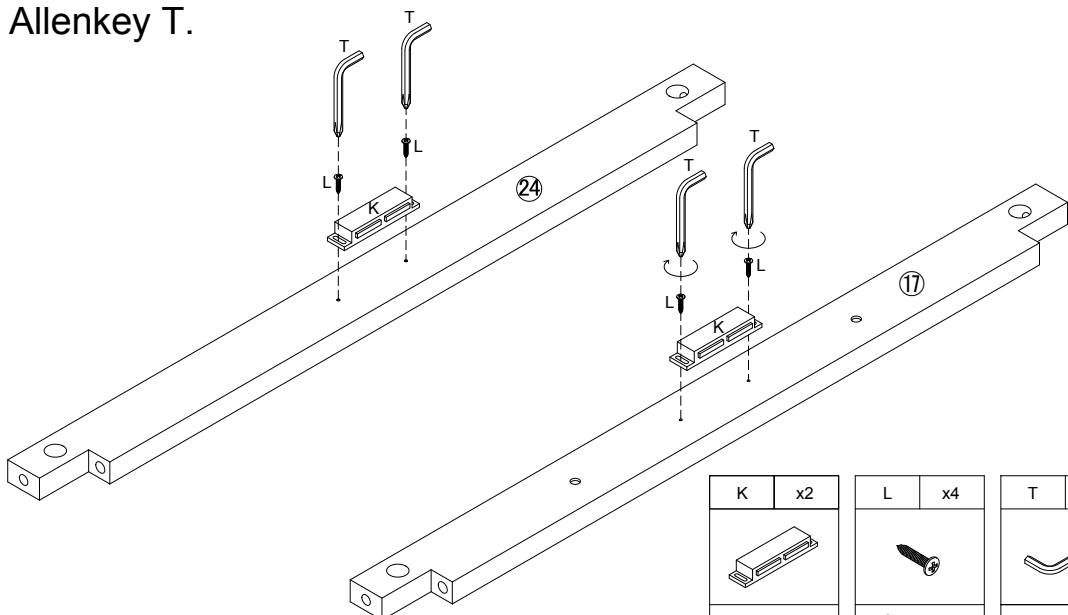
STEP 2

Prepare the part 17 and 24. Align the hole in part 17 and 24 to the hole in part K, screw in the screw L into the hole and tighten by Allenkey T.



| | | | | | |
|---|----|---|----|---|----|
| K | x2 | L | x4 | T | x1 |
|  | |  | |  | |
| | | Ø3*16mm | | M4 | |

ASSEMBLY

INSTRUCTIONS

STEP 3

Prepare the parts 5,6,10,15,16.

- 1) align the hole in the part 5 to the part F, screw in the screw G from the back of part 5 to connect part F, then tighten by Allenkey T.
repeat the same way to finish 6, 15,16.
- 2) align the hole in the part 10 to the part E, screw in the screw S from the back of part 10 to connect part E, then tighten by Allenkey T.

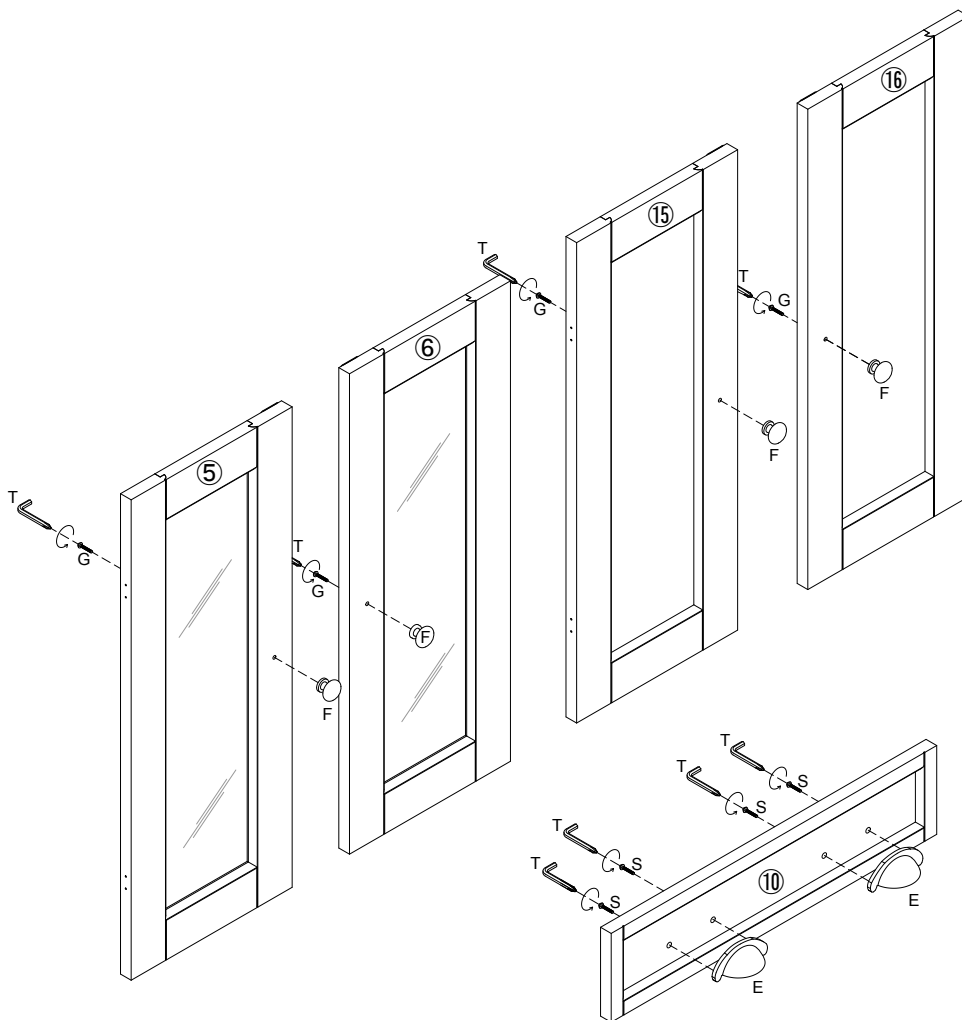

| | | | | | | | | | |
|---|----|---|----|------------|----|------------|----|----|----|
| E | x2 | F | x4 | G | x4 | S | x4 | T | x1 |
| | | | | | | | | | |
| | | | | Ø5/32*3/4" | | Ø5/32*5/8" | | M4 | |

ASSEMBLY INSTRUCTIONS

STEP 4

Connect part 11, 12 to part 13.

- 1) align the hole in part 11 to the hole in part 13, screw in the screw H and tighten by Allenkey T. repeat the same way to finish connect part 12 to part 13 as the picture show.
- 2) align then part 14 to the groove in 11,12,13, insert and slide part 14 down to the end. be sure part 14 into the groove in part 13.

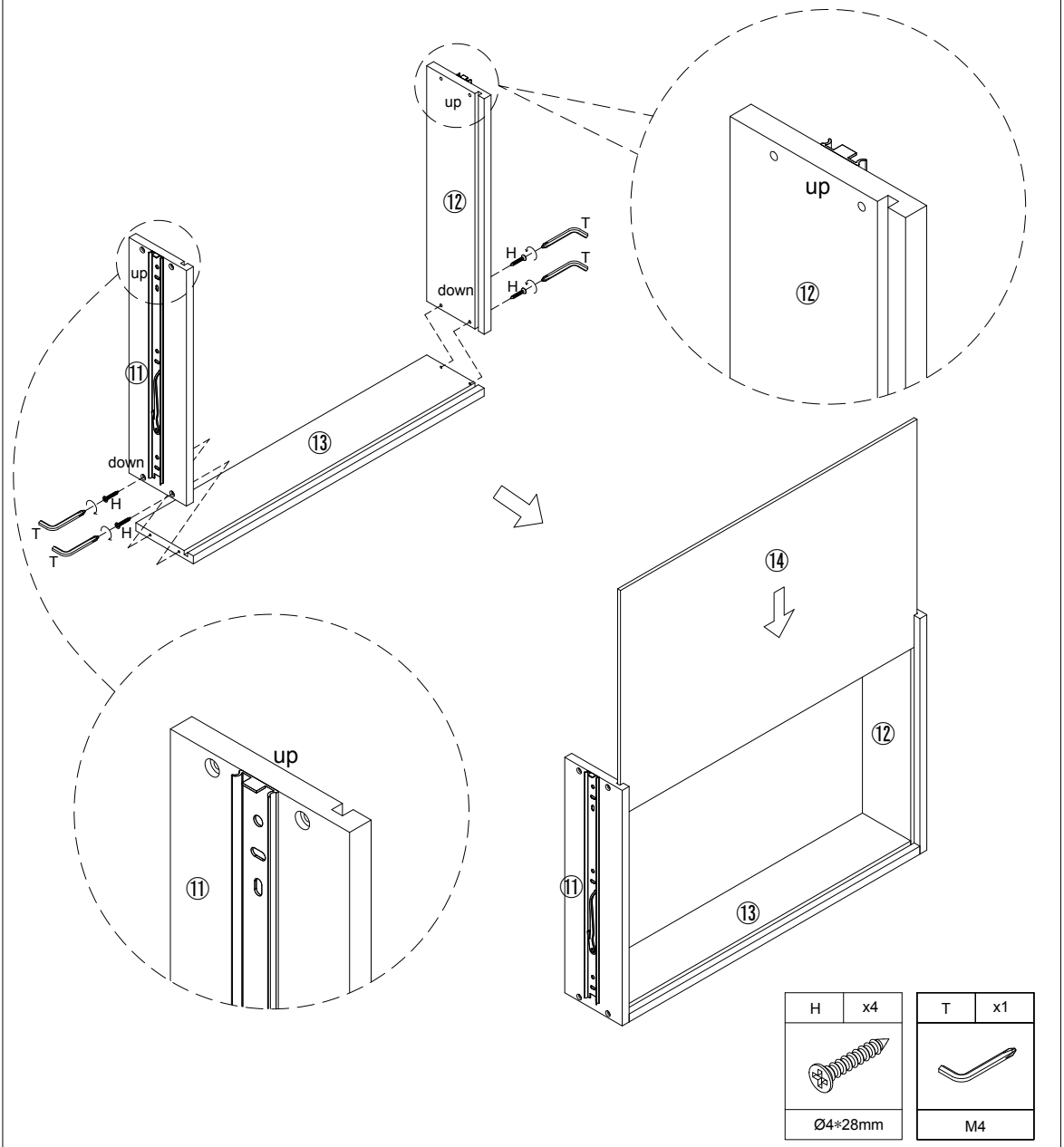



ASSEMBLY INSTRUCTIONS

STEP 5

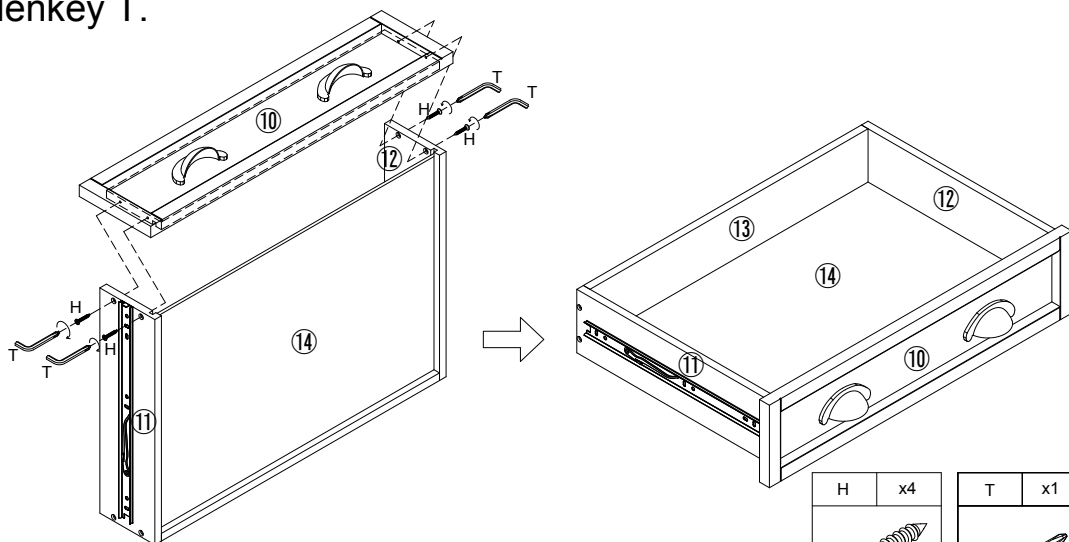
Connect part 10 to the finished part in step 4. align the hole in part 10 to the hole in part 11 and 12. screw in the screw H and tighten by Allenkey T.







| | | | |
|--|----|---|----|
| H | x4 | T | x1 |
|  | |  | |
| Ø4*28mm | | M4 | |

STEP 6

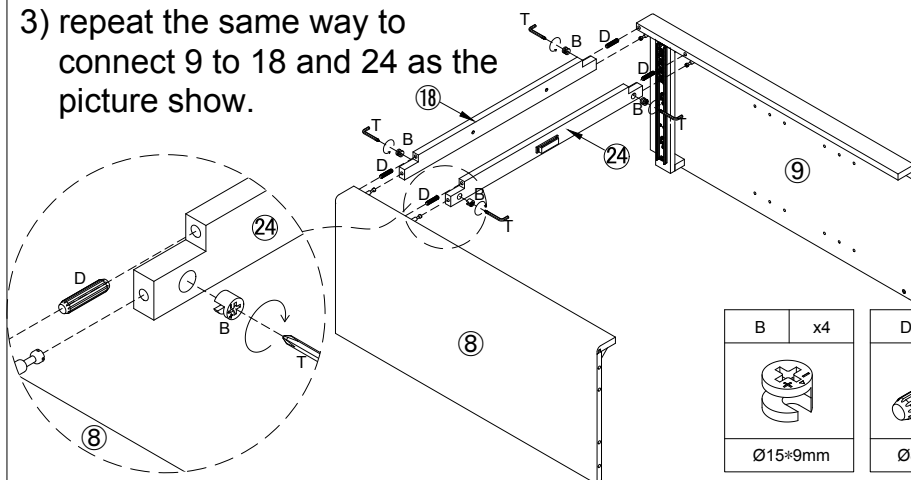
Connect the part 8,9 to the part 18, 24.

- 1) insert the part D into the hole in 18 and 24 by hand as the picture show.
- 2) Align the hole in part 18 and 24 to the Cambolt A in 8, align the hole in part 8 to the wooden dowel D, insert the Cam bolt A and wooden dowel D into the hole in 18,24 and 8 at the same time, then insert the nut B into the hole in part 18,24 (be sure the arrow towards the Cam bolt A), tighten the nut by Allenkey T.
- 3) repeat the same way to connect 9 to 18 and 24 as the picture show.



| | | | | | |
|---|----|--|----|---|----|
| B | x4 | D | x4 | T | x1 |
|  | |  | |  | |
| Ø15*9mm | | Ø8*30mm | | M4 | |

ASSEMBLY



INSTRUCTIONS

STEP 7

Connect part 19 to the finished part in step 6.

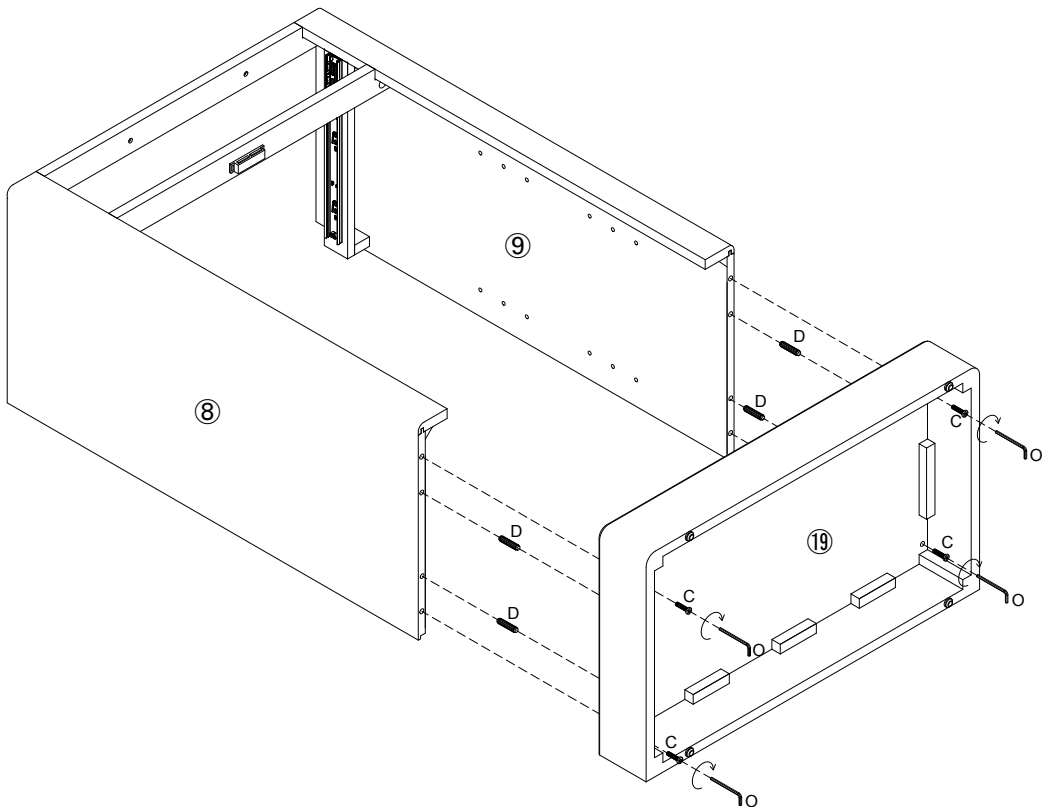
- 1) insert the wooden dowel D into the hole in part 8 and 9 as the picture show.
- 2) align the hole in part 19 and insert the wooden dowel D into the hole in part 19, then
- 3) align the hole in part 19 to the hole in part 8 and 9, screw in the screw C and tighten by Allenkey O.



| | | | | | |
|---|----|--|----|---|----|
| C | x4 | D | x4 | O | x1 |
|  | |  | |  | |
| Ø1/4*1" | | Ø8*30mm | | M4 | |





ASSEMBLY INSTRUCTIONS

STEP 8

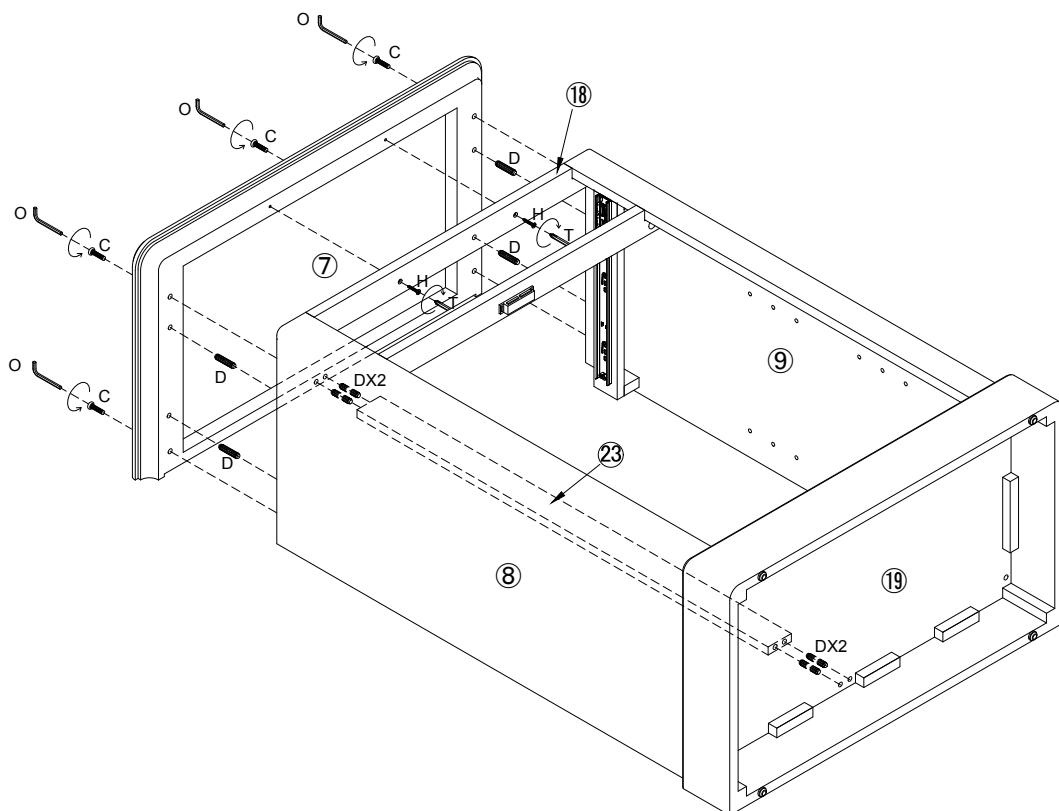
Assemble the part 7 to the finished part in step 7.

- 1) insert the wooden dowel D into the part 8,9,23 by hand as the picture show.
- 2) connect the part 23 to the part 19 by insert the part D, then
- 3) insert the part D in part 8,9, 23 into the hole in part 7.
- 4) align the hole in part 7 to the hole in part 8,9,screw in the screw C by allenkey O.
- 5) Align the hole in part 18, screw in the screw H and tighten by screwdriver T.



| | | | | | | | | | |
|---|----|---|----|---|----|--|----|---|----|
| C | x4 | D | x8 | H | x2 | O | x1 | T | x1 |
|  | |  | |  | |  | |  | |
| Ø1/4*1" | | Ø8*30mm | | Ø4*28mm | | M4 | | M4 | |

ASSEMBLY INSTRUCTIONS

STEP 9

Connect part 17 to the part 2 and 3.

- 1) insert the part D into the hole in part 17 by hand as the picture show.
- 2) align the hole in the part 17 and part 2, 3, insert the part D and cambolt A at the same time, then put in the nut B and tighten by part T screwdriver head.

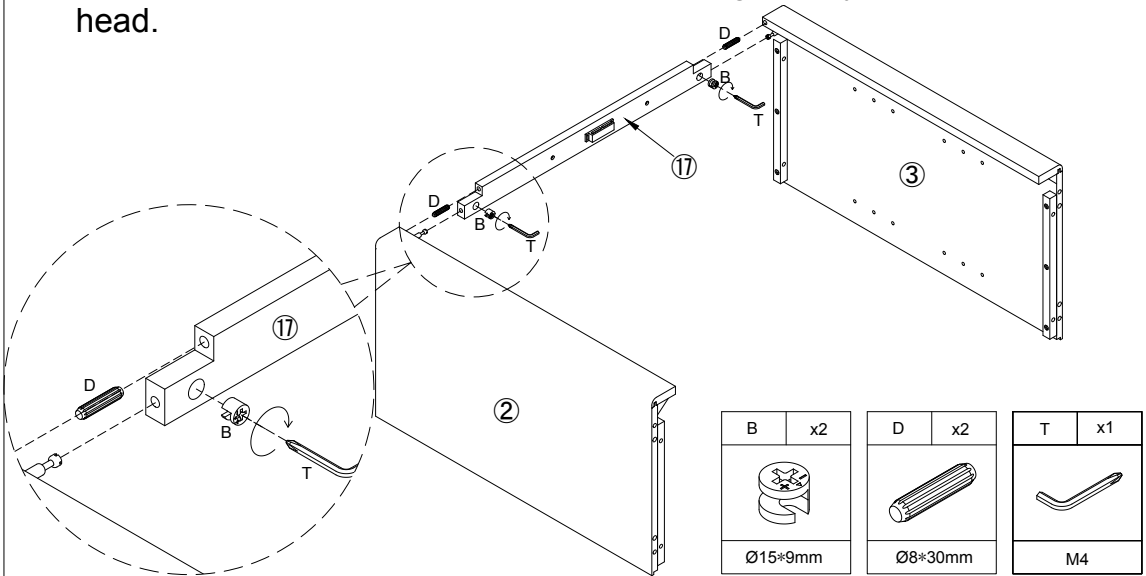

STEP 10

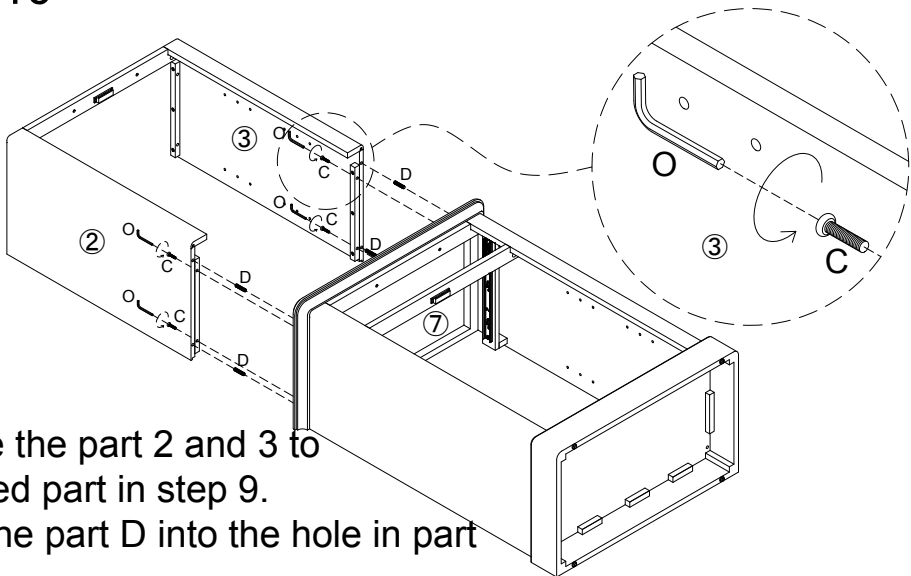

Assemble the part 2 and 3 to the finished part in step 9.

- 1) insert the part D into the hole in part 7, then
- 2) align the hole in part 2 and 3 to the part D in part 7, insert the part D, then screw in the screw C and tighten by Allenkey O.

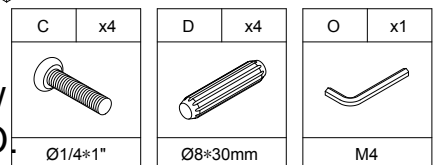





ASSEMBLY INSTRUCTIONS

STEP 11

Assemble the part 1 to the finished part in step 10.

- 1) insert the part D into the hole in part 4, then insert into the hole in part 7;
- 2) insert the part D into the hole in part 2,3,;
- 3) align the hole in part 1 to the part D in part 2 and 3, 4 ,insert the part D , then screw in the screw C and tighten by Allenkey O.
- 4) Align the hole in the part 17 to the hole in part 1, screw in the screw H and tighten by screwdriver T.

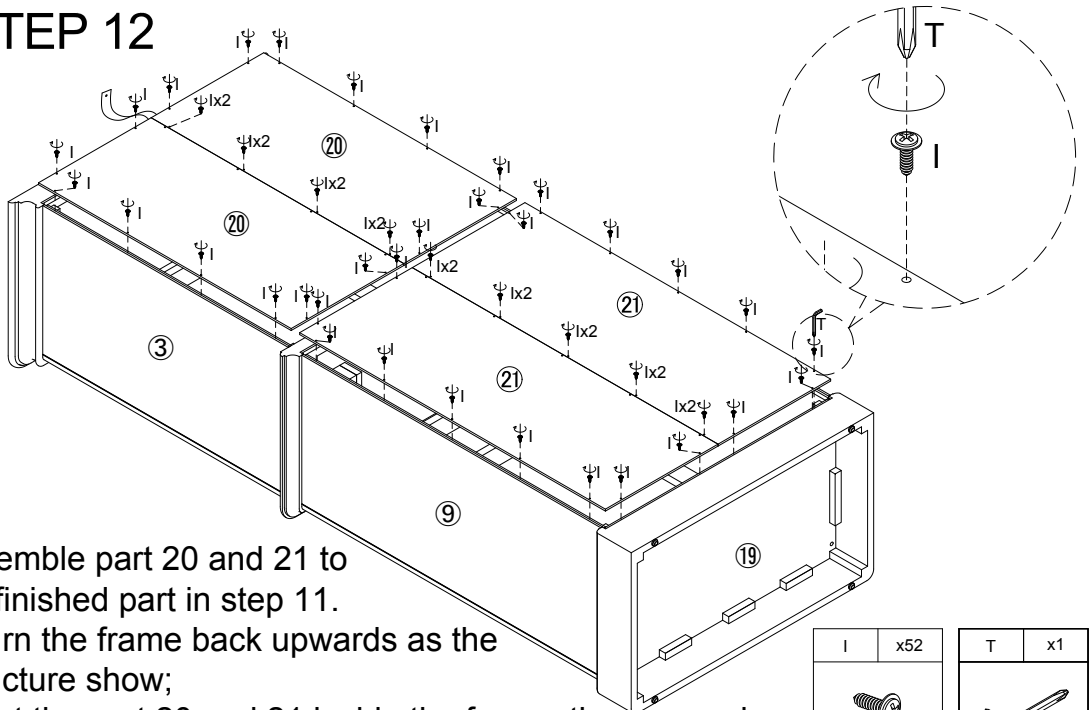

| | | | | | | | | | |
|---|----|---|----|---|----|--|----|---|----|
| C | x4 | D | x8 | H | x2 | O | x1 | T | x1 |
|  | |  | |  | |  | |  | |
| Ø1/4*1" | | Ø8*30mm | | Ø4*28mm | | M4 | | M4 | |

STEP 12



Assemble part 20 and 21 to the finished part in step 11.

- 1) turn the frame back upwards as the picture show;
- 2) put the part 20 and 21 inside the frame, then screw in the screw I and tighten by tool T screwdriver cross-head.

| | | | |
|---|-----|---|----|
| I | x52 | T | x1 |
|  | |  | |
| Ø3*16mm | | M4 | |

ASSEMBLY INSTRUCTIONS

STEP 13

Assemble the doors.

- 1) open the part M; the middle part put on part 3 and frame on part 6;
- 2) align the hole in part M to the pre-drilled hole in part 3,6, screw in the screw J and tighten by tool T screwdriver head. repeat the same way to finish part M to part 9 and 16.
- 3) open the part M; the middle part put on part 2 and frame on part 5;
- 4) align the hole in part M to the pre-drilled hole in part 2,5, screw in the screw J and tighten by tool T screwdriver head. repeat the same way to finish part M to part 8 and 15.

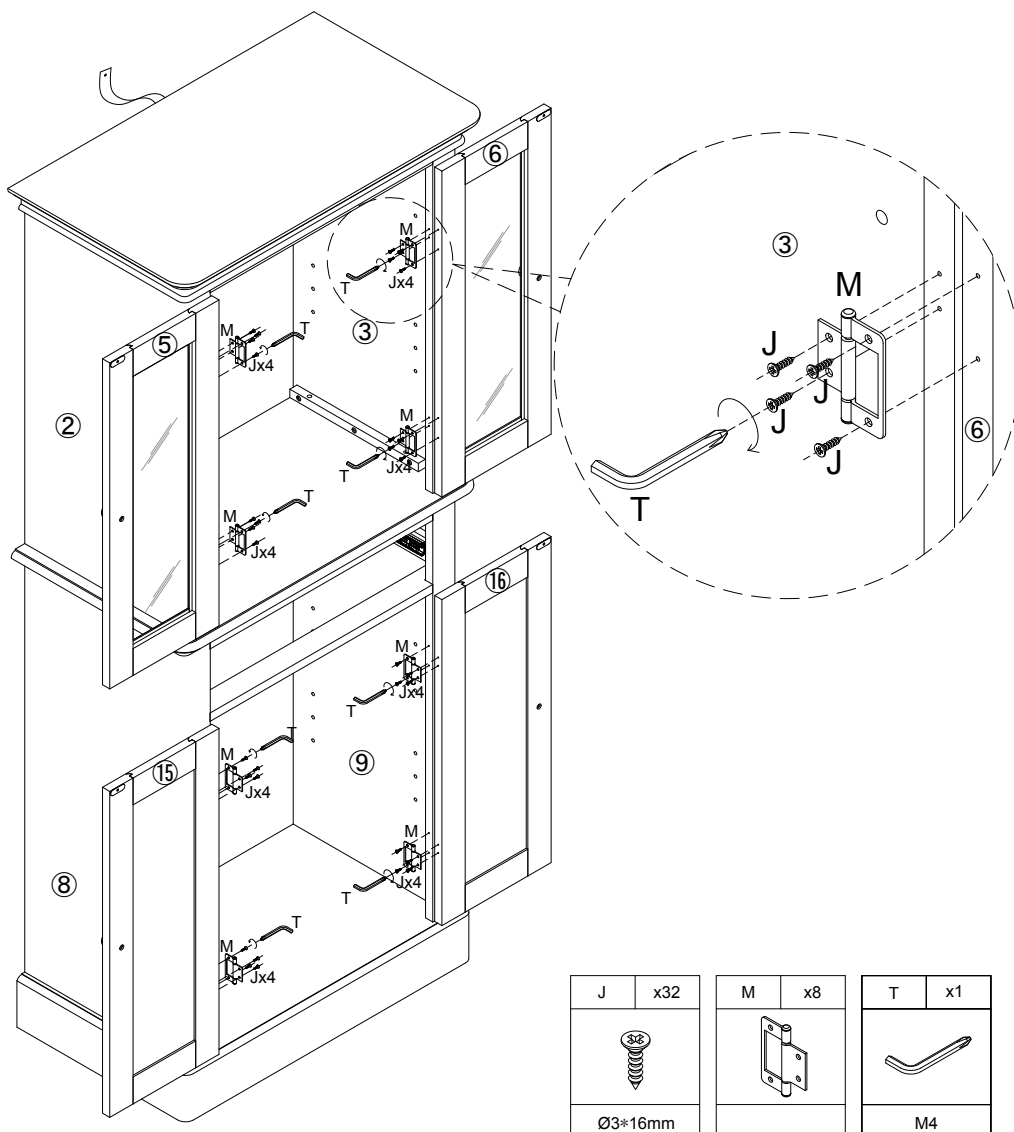

ASSEMBLY

INSTRUCTIONS

STEP 14

Attche the part N in the pre-drilledhole.

- 1) align the hole in the part 2,3,8 and 9, insert the Part N into the hole as the pictureshow. Besure left and right is the same hole!
- 2) there are 3 holes for you to choose.

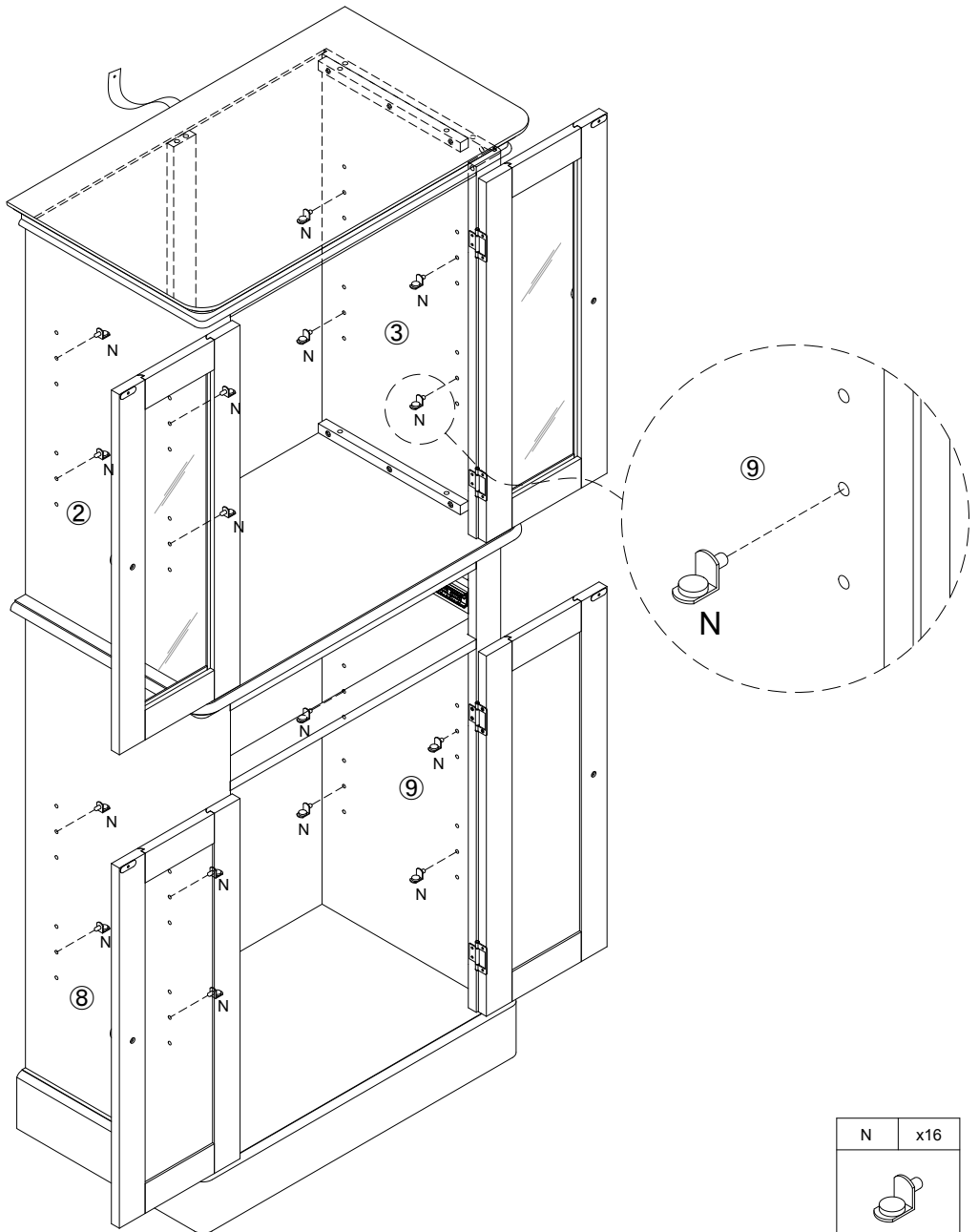

| | |
|---|-----|
| N | x16 |
|  | |
| | |

ASSEMBLY INSTRUCTIONS

STEP 15

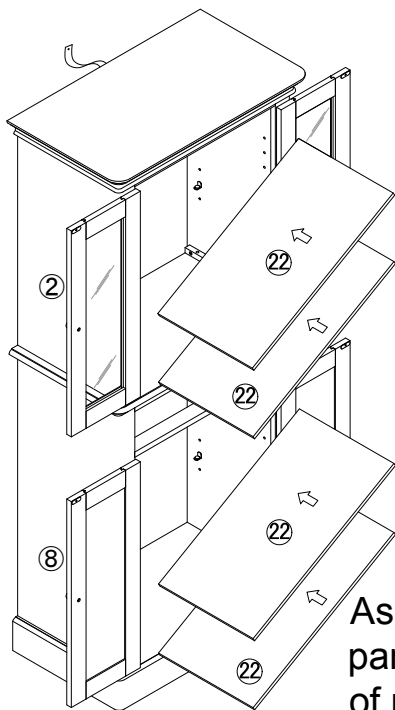

Assemble the part 22 into the finished part in step 14. put the part 22 on the top of part N to have shelf as picture show.

STEP 16

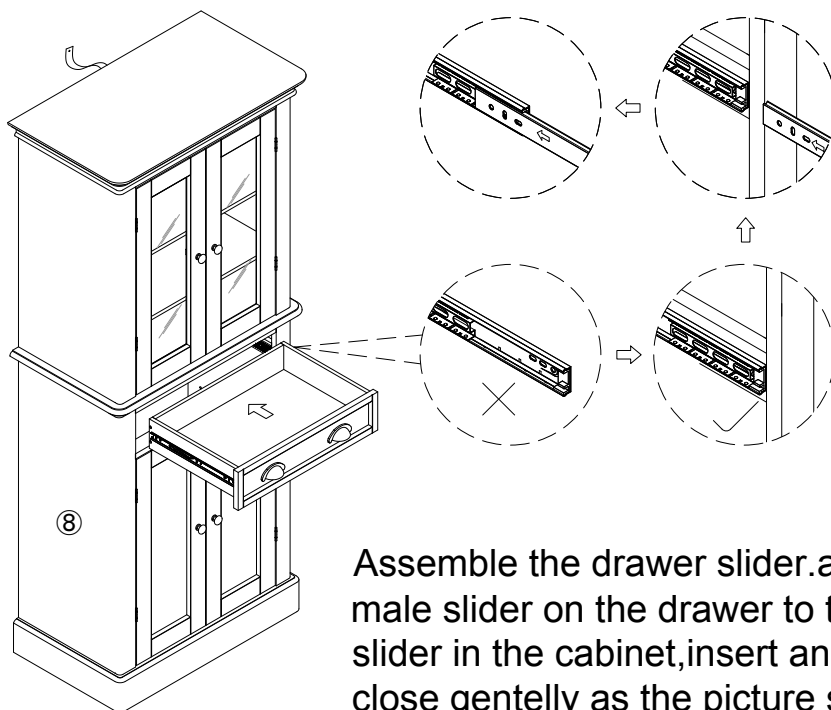

Assemble the drawer slider. align the male slider on the drawer to the female slider in the cabinet, insert and push to close gently as the picture show.

ASSEMBLY



INSTRUCTIONS

STEP 17

Installing ANTI-COLLAPSE Device

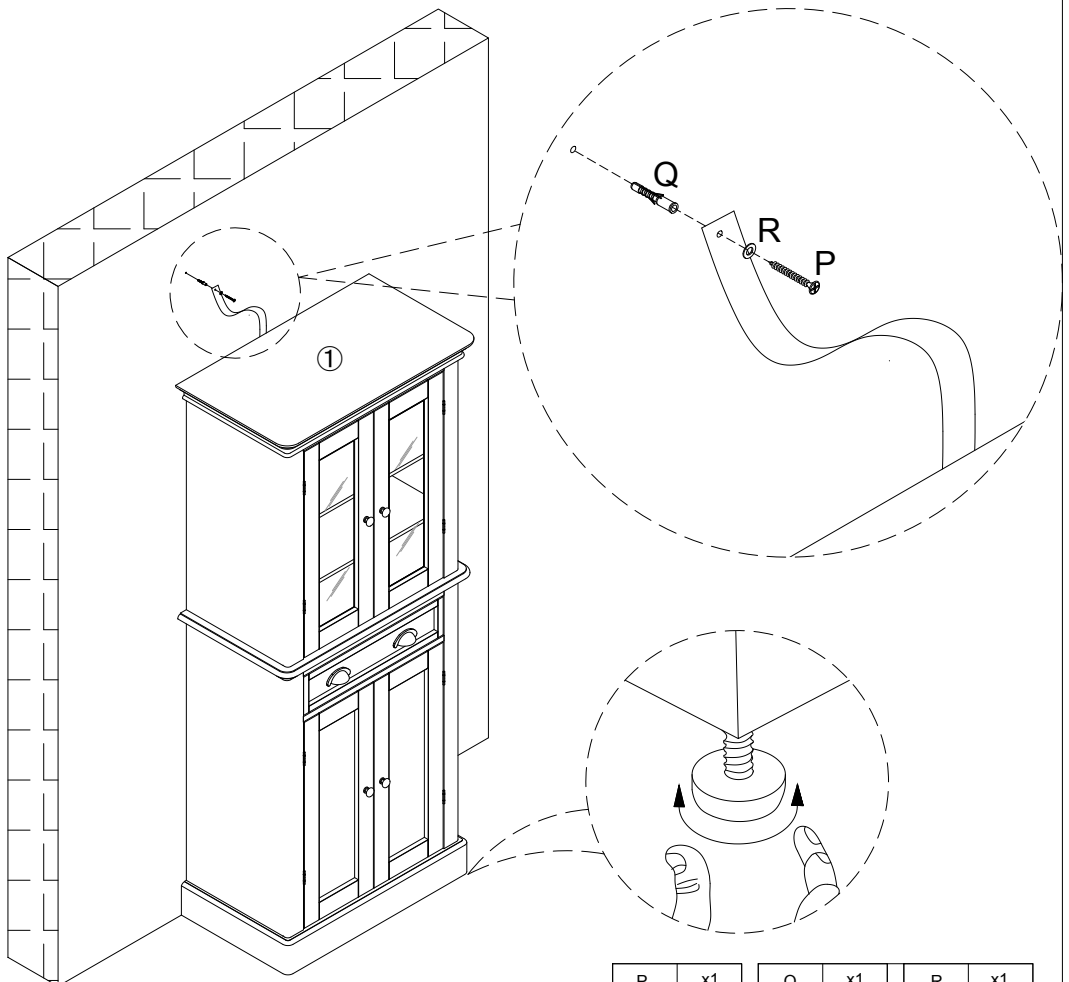
- 1) mark the same height as part 1 on the wall, then hit the part Q into the wall by hammer(not provided), and screw in the screw P with part R, tighten by tool T.
- 2) move the cabinet against the wall(use the adjust nail to keep the cabinet even if need as the picture show)now , your cabinet is ready to use.



| | | | | | |
|---|----|--|----|---|----|
| P | x1 | Q | x1 | R | x1 |
|  | |  | |  | |
| Ø4*38mm | | | | | |

WARRANTY

We strive to offer high-Quality products, and we also try our best to satisfy each and every customer that orders from us with product or service as needed. We provide 30 days warranty starting from the time you receive the item. Each customer must provide a record of their order such as the order number, or item receipt for any items that are out of the warranty period you may also still receive replacement parts by purchasing them with our company if they are available.

Are you having difficulty
with assembly? Missing parts?

Please send email with your order No

customerservice@hulalahome.com

For return, Please check the return policy with
the retailer or MarkevPlace you bought from.

Appreciated your purchasing from us..

Pop up your life by our furniture piece!