

CEILING FAN

SLF-5203-DC

IMPORTANT SAFETY INFORMATION >>>

! Warning: To reduce the risk of fire, electric shock, or injury, please observe the following precautions before beginning installation:

1. To reduce the risk of electric shock, ensure that the electricity has been turned off at the circuit breaker or fuse box before you begin.
2. All wiring must be in accordance with the National Electrical Code ANSI/NFPA70-1999 and local electrical codes. Electrical installation should be performed by a qualified licensed electrician.
3. The outlet box and support structure must be securely mounted and capable of reliably supporting 66 lbs (30 kg). Use only UL Listed outlet boxes marked "Acceptable for Fan Support of 66 lbs (30 kg) or less".
4. The fan must be mounted with a minimum of 7 ft. (2.1 m) clearance from the trailing edge of the blades to the floor.
5. Do not operate the reversing switch while the fan blades are in motion. You must turn the fan off and stop the blades before you reverse the blade direction.
6. Do not place objects in the path of the blades. To mitigate the risk of personal injury, refrain from bending the blade brackets (also known as flanges) during assembly or post-installation.
7. To avoid personal injury or damage to the fan and other items, use caution when working around or cleaning the fan.
8. Electrical diagrams are for reference only. Light kits that are not packed with the fan must be UL-listed and marked suitable for use with the model fan you are installing. Switches must be UL General Use Switches. Refer to the instructions packaged with the light kits and switches for proper assembly.
9. After making electrical connections, spliced conductors should be turned upward and pushed carefully up into the outlet box. The wires should be spread apart with the grounded conductor and the equipment-grounding conductor on one side of the outlet box.
10. All setscrews must be checked and re-tightened where necessary before installation.

1

PRE-INSTALLATION >>>

TOOLS REQUIRED

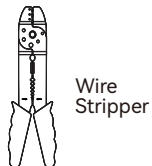
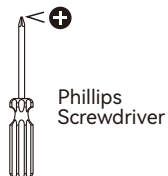

PART LIST

Motor	Blades x 5	Canopy	Decorative Cover
Downrod	Hanging Bracket	Light Kit	Lampshade
5 Inches 10 Inches 			

Remote Controls	Receiver	Expansion Screws	Wall Bracket Screws
		Self-tapping Screws	Wire Nut
		Fan Blade Screws	Balancing Kit
		x 15 x 15	

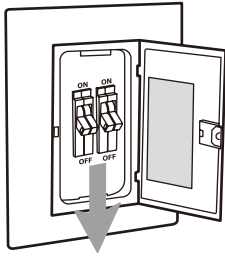

Before installation, please ensure that the electricity has been turned off at the circuit breaker or fuse box.

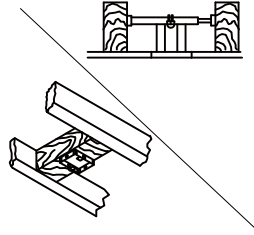

Before installation, please ensure the outlet box and support structure must be securely mounted and capable of reliably supporting 66 lbs. (30 kg).

2

PRODUCTION INSTRUCTION >>>

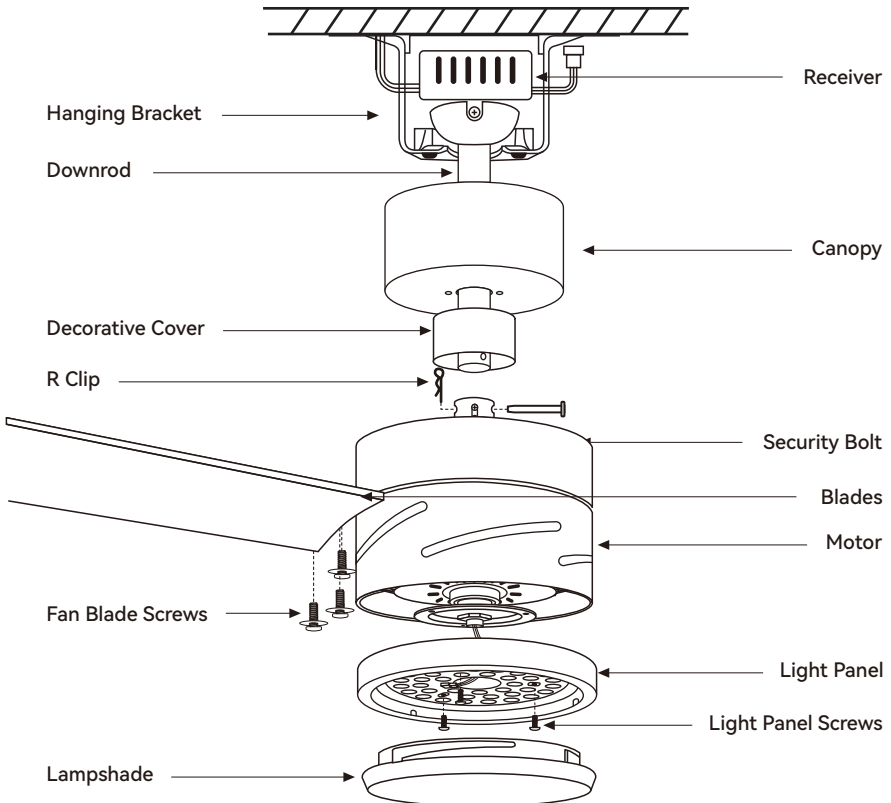

3

INSTALLATION STEPS >>>

Step 1

Installation of the Hanging Bracket

WOODEN CEILING

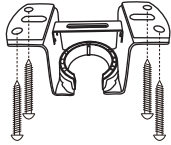

Self-tapping Screws

- To install on wooden ceiling, use the **self-tapping screws** to attach the hanging bracket to either the wooden beam or the junction box. Select the appropriate option based on your specific requirements.

CONCRETE CEILING

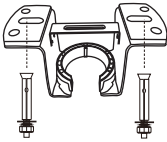

Expansion Screws

- For a concrete ceiling, use an 8mm diameter percussion bit to drill holes to match the length of the expansion screws. Then, use the provided **expansion screws** to secure the hanging bracket to the ceiling. Select the screws based on your specific requirements.

Step 2

Install Fan Blades

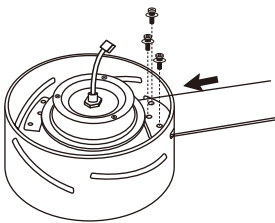

- Connect the fan blades to the motor with screws.

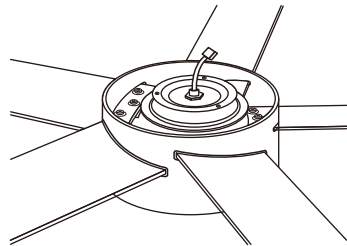

- Tighten the screw to secure it.

Step 3

Install Light Kit and Lampshade

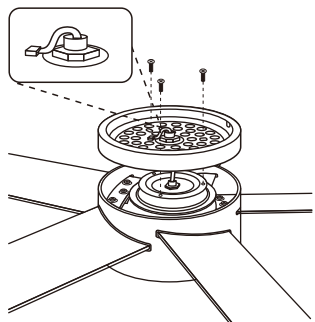

- Connect the wires between the light kit and the motor, then secure the light kit to the motor with screws.

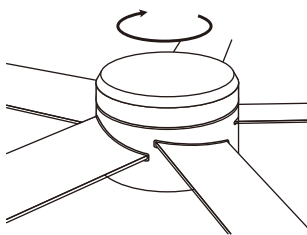

- Place the lampshade into the light kit and twist to tighten.

Step 3

Assembling the Canopy and Downrod

5"

10"

- First choose a downrod of suitable length for you.

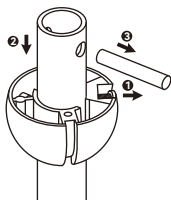

- Remove the hanger ball.

- 1 Loosen the two set screws for hanger ball.
- 2 Move the hanger ball down.
- 3 Remove the middle cross pin.

- Insert the downrod into the groove on the top of the motor.

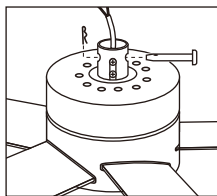

- 1 Pull out the R-clip and take out the security bolt.

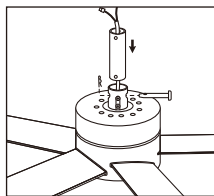

- 2 Thread the wire through the hollow center of the downrod.

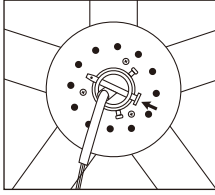

- 3** Insert the security bolt to connect the motor and downrod.

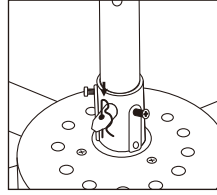

- 4** Insert the R-clip to secure and tighten the remaining two screws.

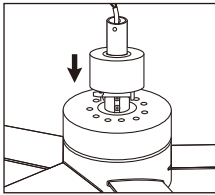

- 5** Put in the motor decorative cover.

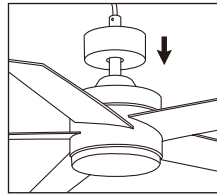

- 6** Put in the canopy.

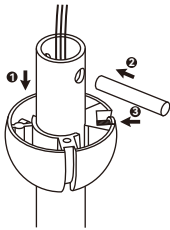

- Install the hanger ball.

- 1** Put the hanging ball back on the downrod.
- 2** Insert the cross pin.
- 3** Engage the cross pin and tighten the screws.

Step 4 Hanging the Ceiling Fan

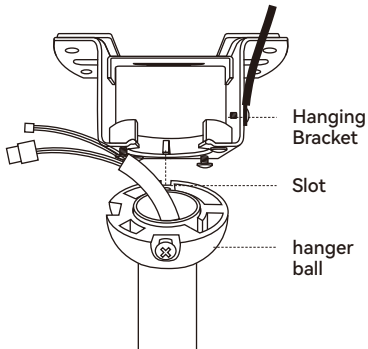

- Hang the ceiling fan onto the circular part of bracket, rotate it goes down into the slots.

Step 5

Install the Receiver and Connect the Lines

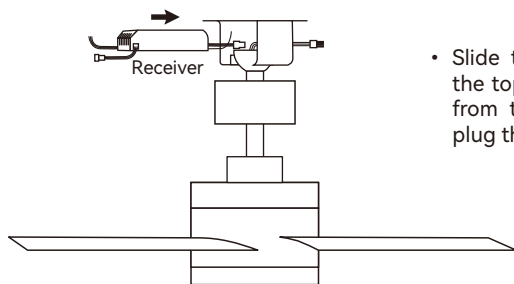

- Slide the receiver for the remote into the top of the bracket. Unplug the wire from the sensor to get that in there, plug the wires back in.

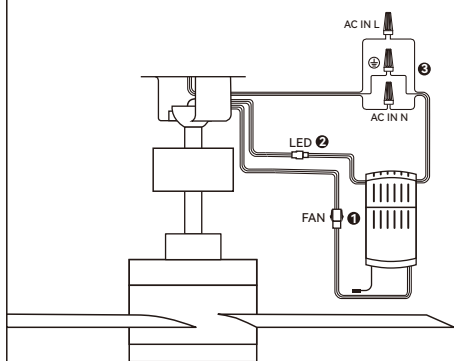

- Breakdown of wiring steps.

- 1 Connect male and female terminal wires of the receiver and motor.
- 2 Light control wire connecting motor to receiver.
- 3 Connect the receiver and the ceiling wires of the same color using wire nuts, and wrap them with electrical tape after the connection is completed.

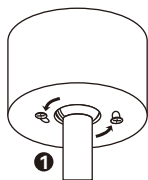

- Install canopy.

- 1 Loosen the two diagonal screws on the suspension, align the holes through the ceiling and rotate.
- 2 Tighten the screws.

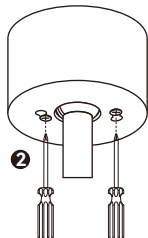

4

REMOTE CONTROL INSTRUCTIONS >>>

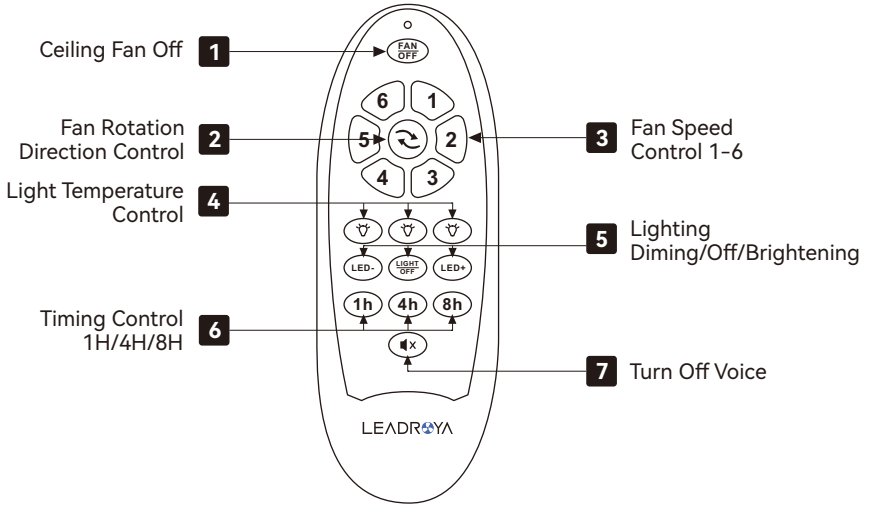

5

CHECK AND OPERATING >>>

- Turn on the power and check fan operation. Make sure you can control the fan speed correctly using the remote control.
- The appropriate speed 1-6 settings for warm or cool weather depend on factors such as room size, ceiling height, and the number of fans.
- The slide  switch controls the direction of the blades: forward (switch down) or reverse (switch up).



NOTE: Before reversing the direction of the blade rotation, please wait until the fan stops.

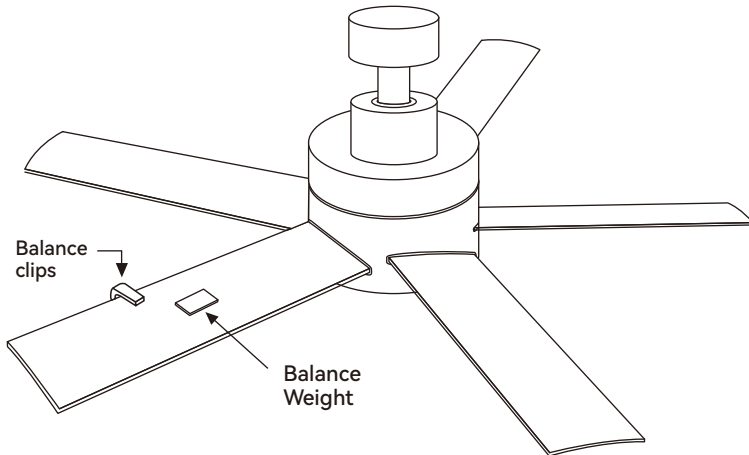

Instructions for Using the Balancing Kit

If there is an unacceptable amount of fan wobble after completing all the steps in your Owner's Manual under "INSTALLATION STEPS", please use the Balancing Kit as follows:

- 1. Determine the Speed with the Greatest Wobble:** Turn the fan on and set the speed control to the setting where the wobble is the greatest.
- 2. Install the Balance Clip:** Turn off the fan and allow it to come to a complete stop. Select one blade and place the balance clip on it, halfway between the blade holder and the blade tip on the trailing edge of the blade.
- 3. Test for Wobble:** Turn the fan on and observe whether the wobble has increased or decreased. Turn the fan off, move the clip to another blade, and retest. Repeat this procedure on all blades, noting the blade on which the greatest improvement is achieved.
- 4. Adjust the Balance Clip Position:** Move the clip back to the blade that showed the greatest improvement. Move the clip inward and outward on this blade and operate the fan to find the position where the clip gives the greatest improvement.
- 5. Install the Balancing Weight:** Remove the clip and install a balancing weight to the top of the blade along the centerline near the point where the clip was positioned.
- 6. Further Adjustment:** If the fan wobble problem has not been corrected, you may wish to try to improve the balancing further by using the balancing clip and additional weights.

Following these steps should help you effectively reduce the wobble of your fan. If the issue remains unresolved, please refer to the contact information at the end of the manual to contact us or Amazon. We will assist you with a replacement, return, or refund.

8

TROUBLESHOOTING >>>

Problem	Solution
The fan will not start.	<ul style="list-style-type: none"> • Check the main and branch circuit fuses or breakers. • Check the line wire connections to the fan and switch wire connections in the switch housing.
The fan is noisy.	<ul style="list-style-type: none"> • Ensure all motor housing screws are snug. • Ensure that the screws attaching the fan blade bracket to the motor hub are tight. • Ensure the wire nut connections are not rattling against each other or the interior wall of the switch housing. • Allow a 24-hour "breaking in" period. Most noises associated with a new fan disappear during this time.
The fan doesn't rotate or rotates slowly upon startup.	<ul style="list-style-type: none"> • These issues are likely caused by poor contact. The terminals (red, pink, gray wires) on the motor may be loose. Follow these steps to resolve the problem: <ol style="list-style-type: none"> 1. Cut off the terminals on the motor. 2. Directly connect the wires without the terminals. 3. Securely wrap the connections using insulating tape to ensure they are well-insulated.
The fan stopping working after a "pop" sound from junction box.	<ul style="list-style-type: none"> • This is due to a wiring connection issue, causing the product to short circuit, please contact us via our email, and we will provide a new remote control and receiver.

9

CONTACT US >>>

If you have any questions, please feel free to contact us via email for installation assistance, part replacement, or order refund. Prompt reply within 12 hours, please reach out to our customer service team at support@leadroya.com.

Alternative method to contact us.
(amazon.com orders only)

1. Log into your amazon account.
2. Go to "Your Orders" and find the "purchased".
3. Click on "Contact Seller".

