

# INSTRUCTION

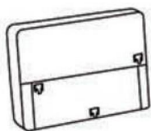

A\*16



B\*1

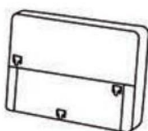

C\*1

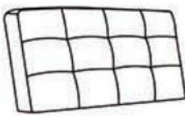

D\*4



E\*1



F\*2

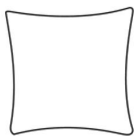

G\*2

## STEP 1

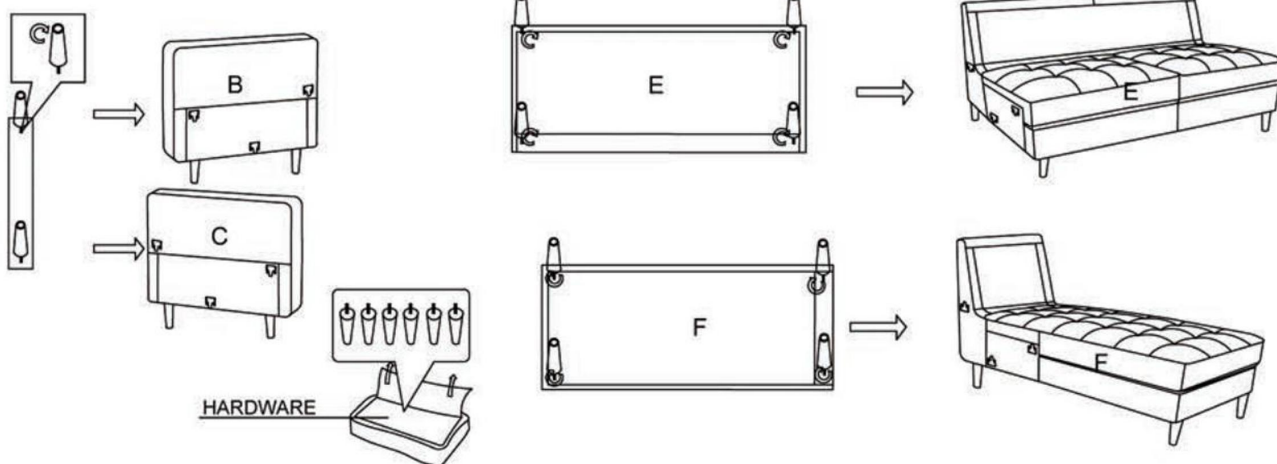

## STEP 2

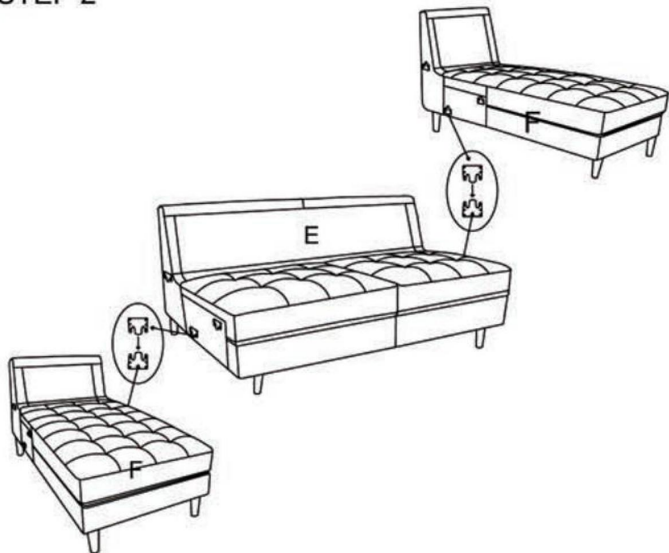

## STEP 3

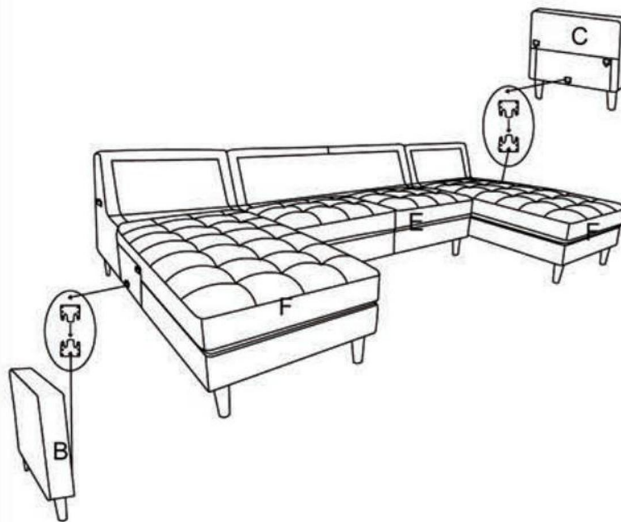

## STEP 4

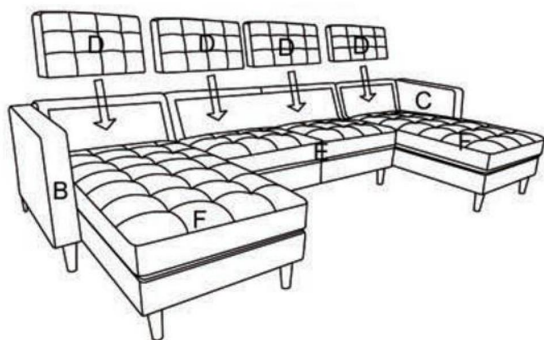

## STEP 5

