

TV STAND-N724P170542

Assembly Instructions - Please keep for future reference.

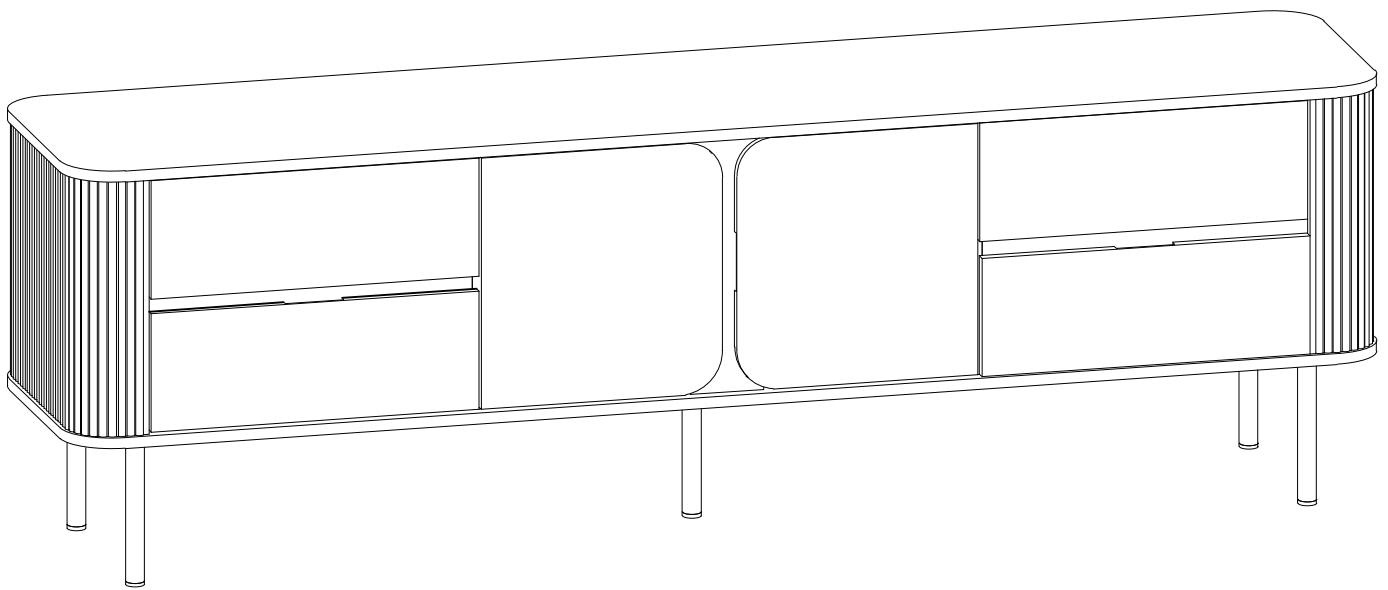

DIMENSIONS

width - 70.87inch

Depth - 15.75inch











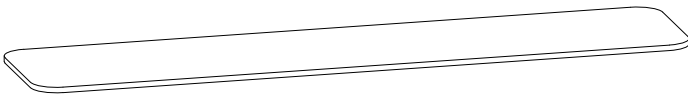
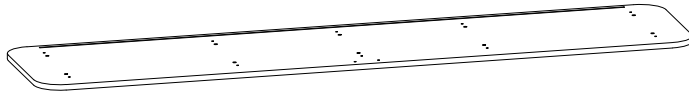
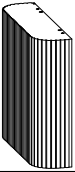

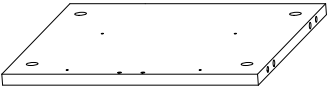
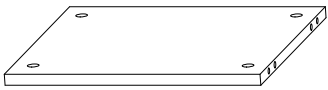
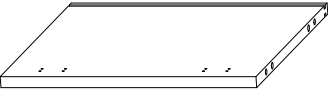

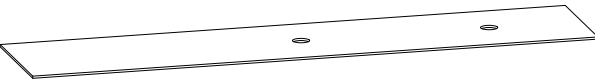

Height - 20.87inch

Important - Please read these instructions fully before starting assembly.

components - fittings

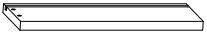
Please check you have all the panels listed below.







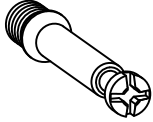

Note: The quantitie below are the correchet amount to complete the assembly. In some cases more fittings may be supplied than are required.

			
① x 1pc		② x 1pc	
			
③ x 1pc	④ x 1pc	⑤ x 1pc	⑥ x 1pc
			
⑦ x 1pc	⑧ x 2pcs	⑨ x 1pc	⑩ x 1pc
			
⑪ x 1pc		⑫ x 2pcs	⑬ x 1pc
			
⑭ x 1pc	⑮ x 1pc	⑯ x 1pc	⑰ x 4pcs
			
⑱ x 4pcs	⑲ x 4pcs	⑳ x 4pcs	

components - fittings

Please check you have all the panels listed below.

Note: The quantitie below are the correchet amount to complete the assembly. In some cases more fittings may be supplied than are required.

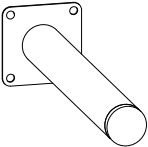
 M6x35mm	 Φ15x9mm	 Φ8x30mm	 M3x12mm
A x 48pcs	B x 48pcs	C x 20pcs	D x 32pcs
	 M4x25mm		 M4x12mm
E x 8pcs	F x 16pcs	G x 4pcs	H x 44pcs
			
I x 1pc	J x 5pcs		

Assembly Instructions

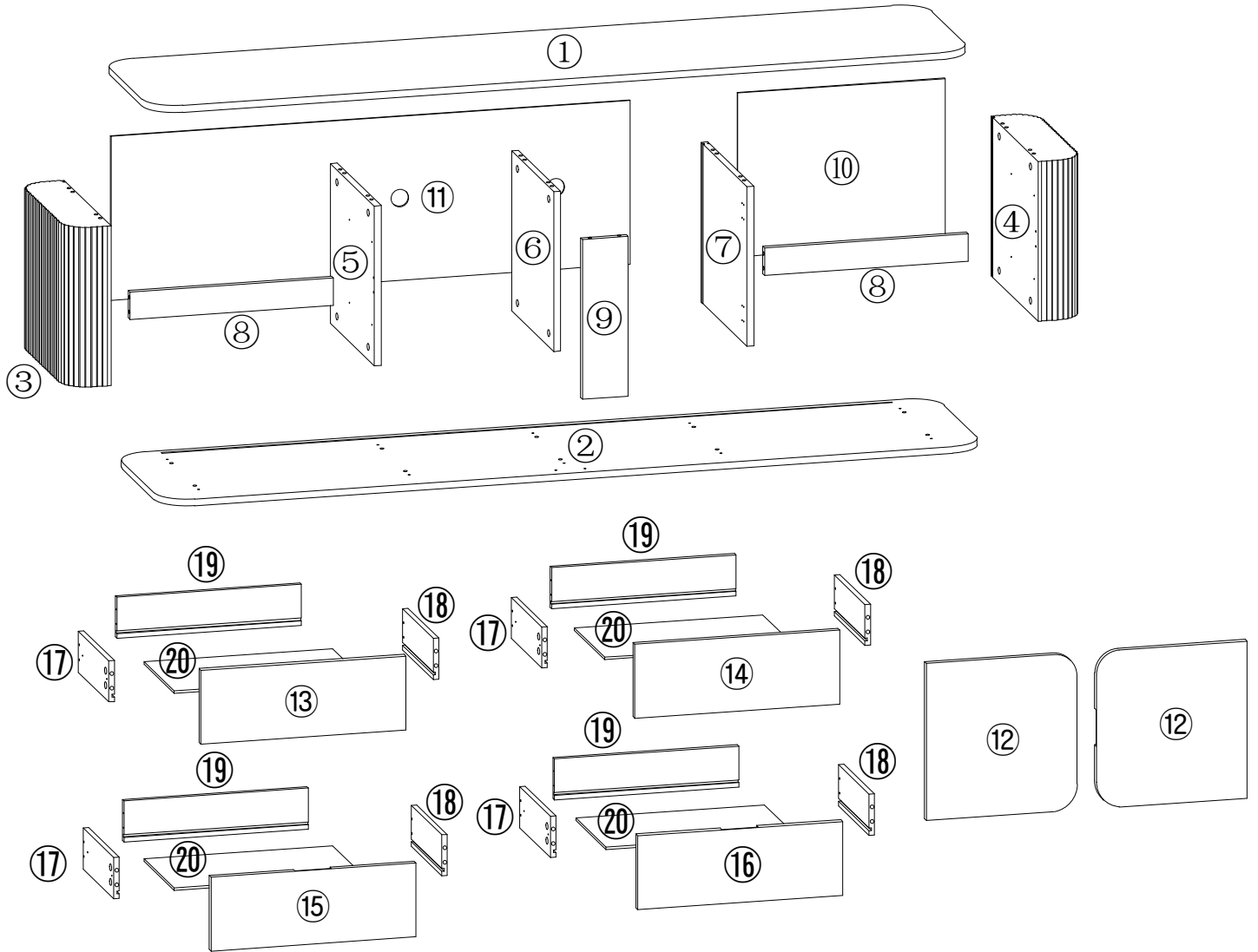

Assembly Instructions

STEP 1

·Slides Must Be Separated Before Assembly.
After Separated, Set Aside Until Needed for Assembly.

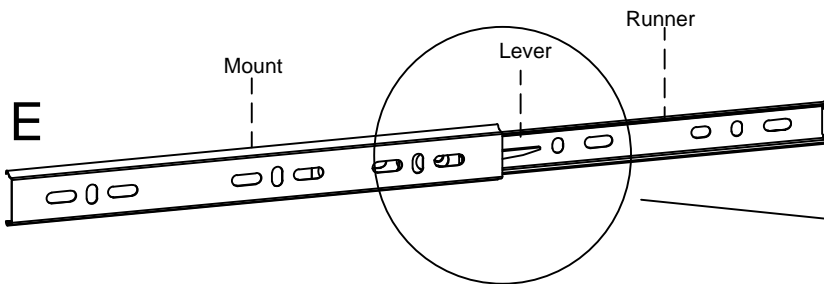

STEP 2 : Push Lever UP

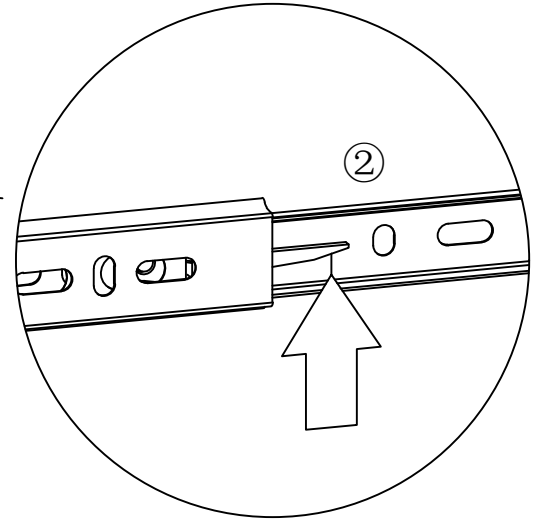

STEP 1 : Extend Slide

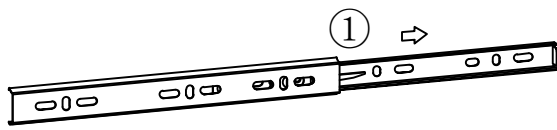



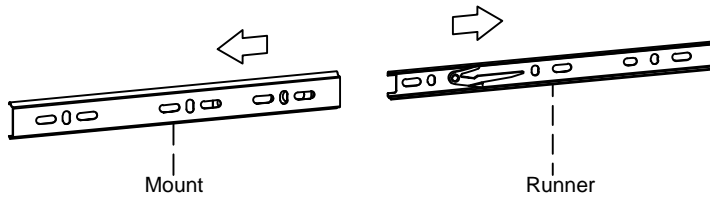

STEP 3 : Remove Runner

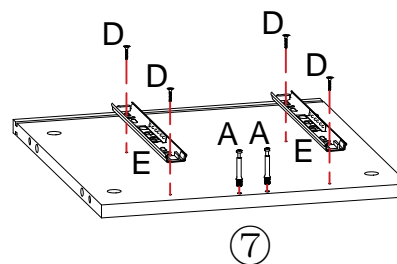
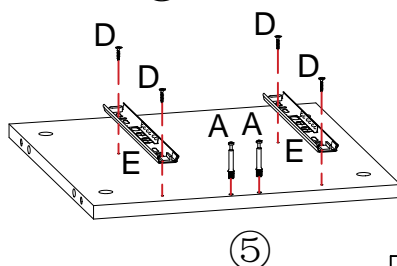
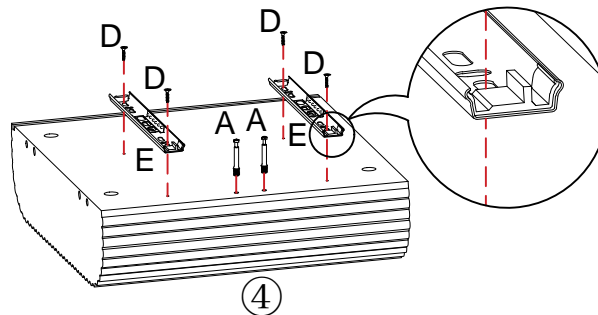
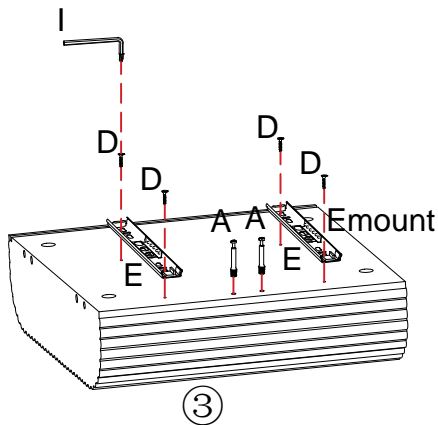
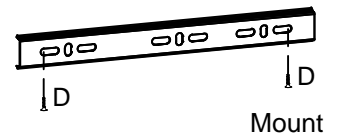

STEP 2

orientation





			
A x8pcs	D x16pcs	E x 8pcs	I x 1pc

Assembly Instructions

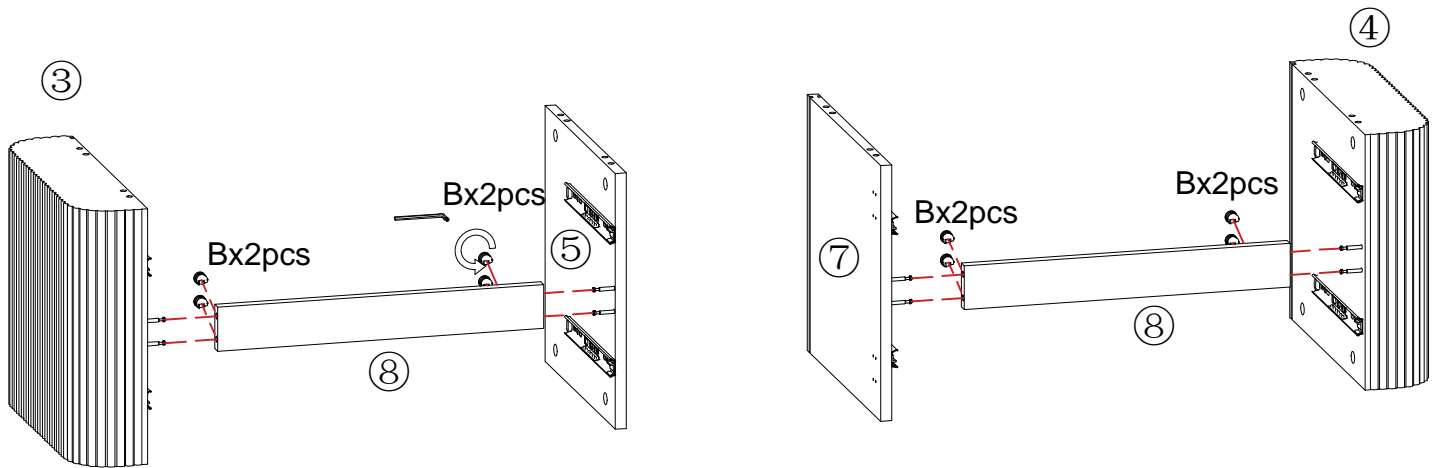

STEP 3

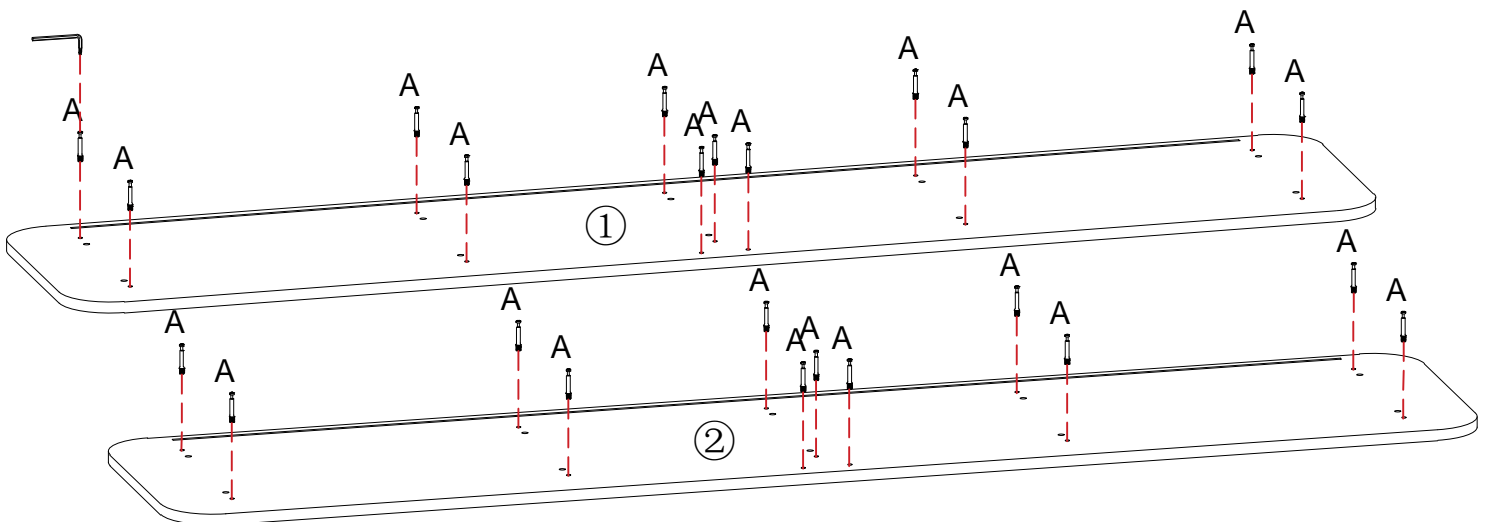

	
B x 8 pcs	I x 1 pc

STEP 4





	
A x 24 pcs	I x 1 pc

Assembly Instructions

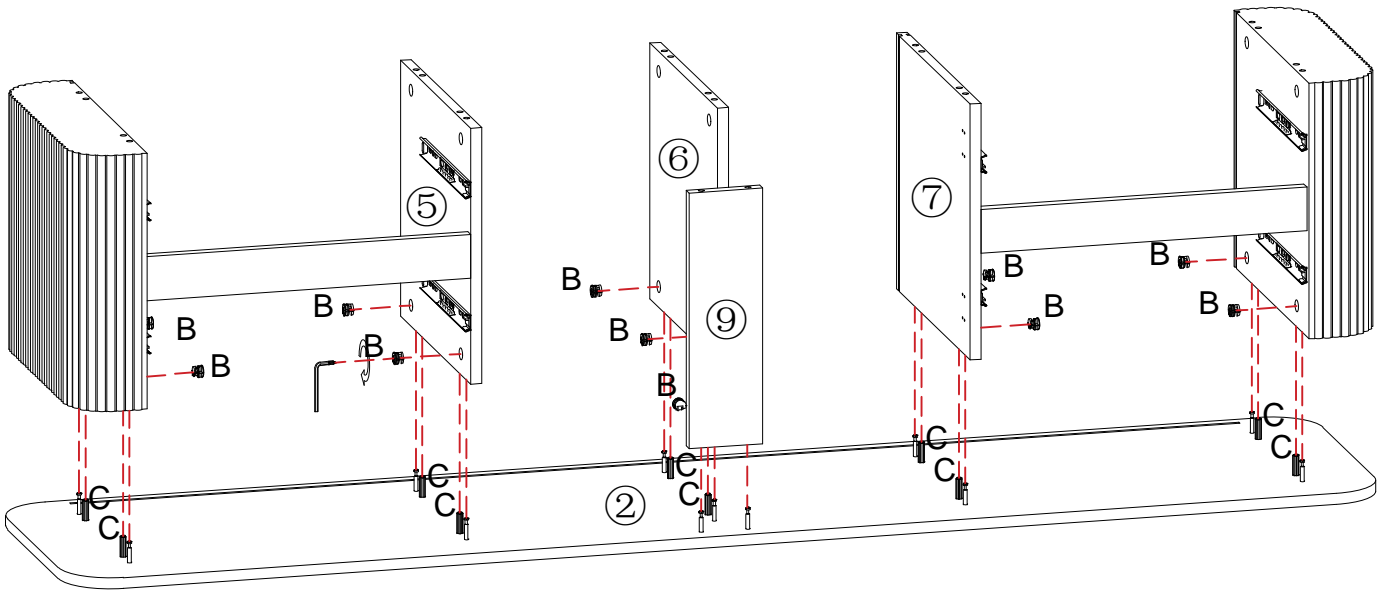
STEP 5



		
B x12pcs	C x 10pcs	I x 1pc

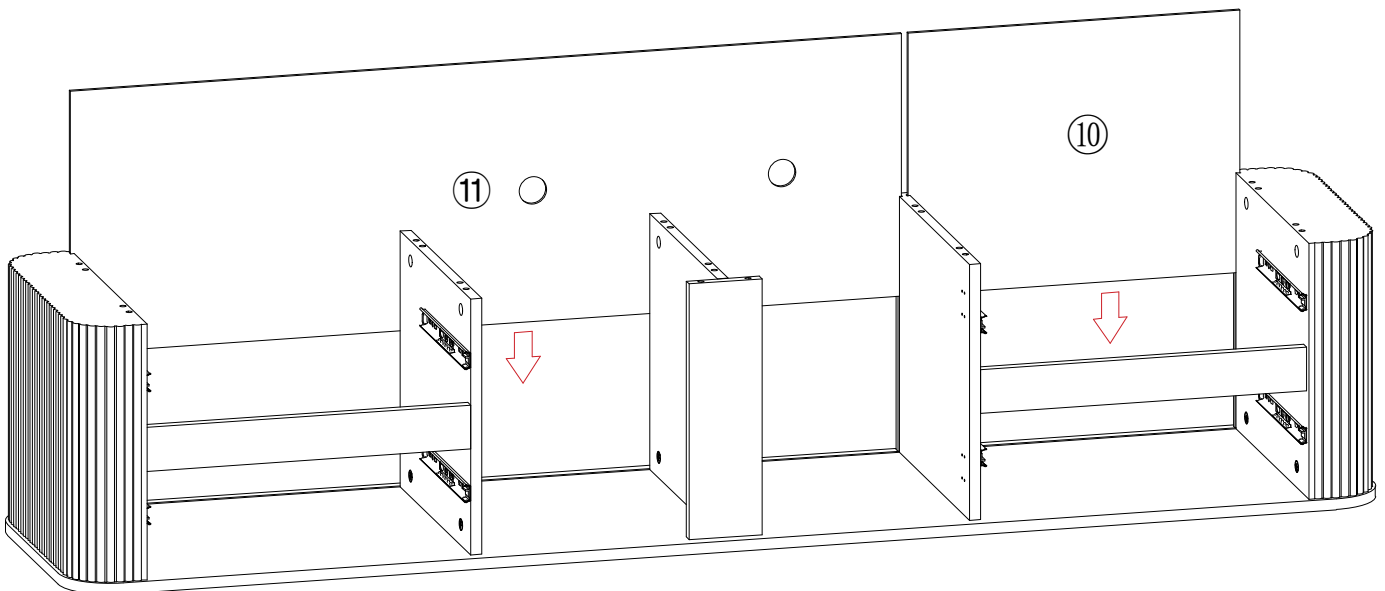

STEP 6



Assembly Instructions

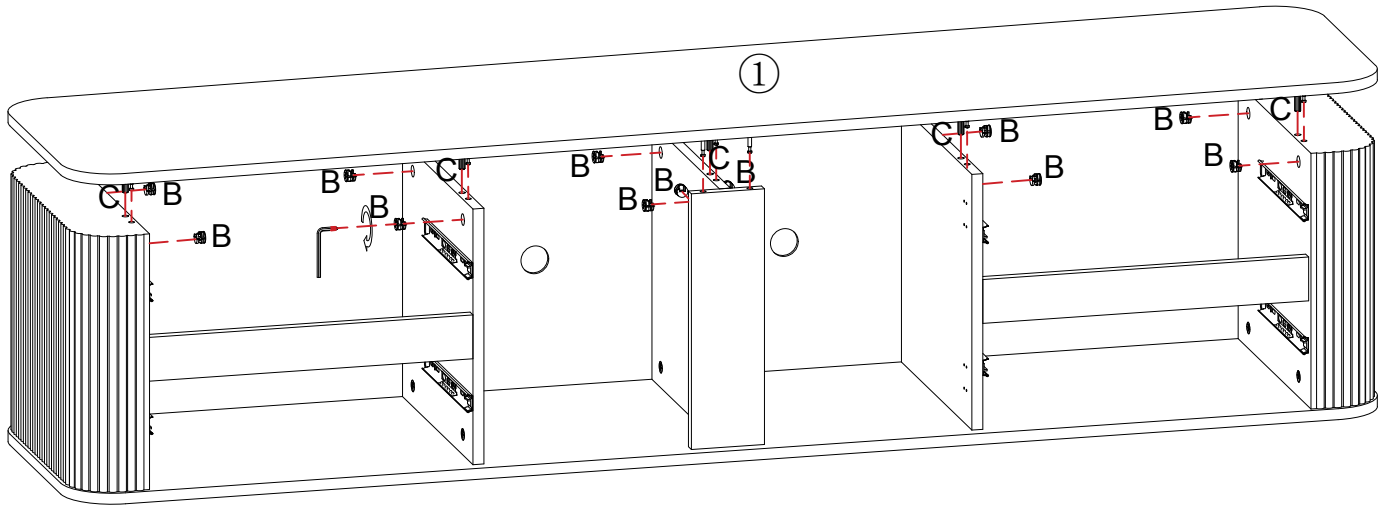

STEP 7

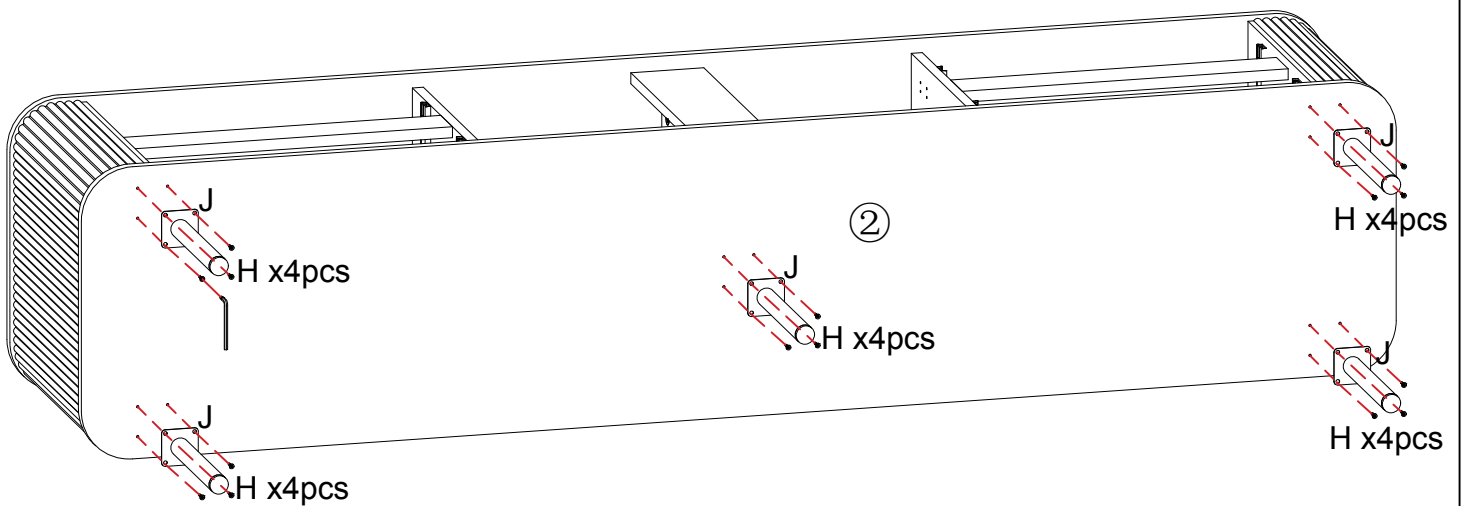

		
B x12pcs	C x 10pcs	I x1pc

STEP 8





		
H x 20pcs	I x1pc	J x 5pcs

Assembly Instructions

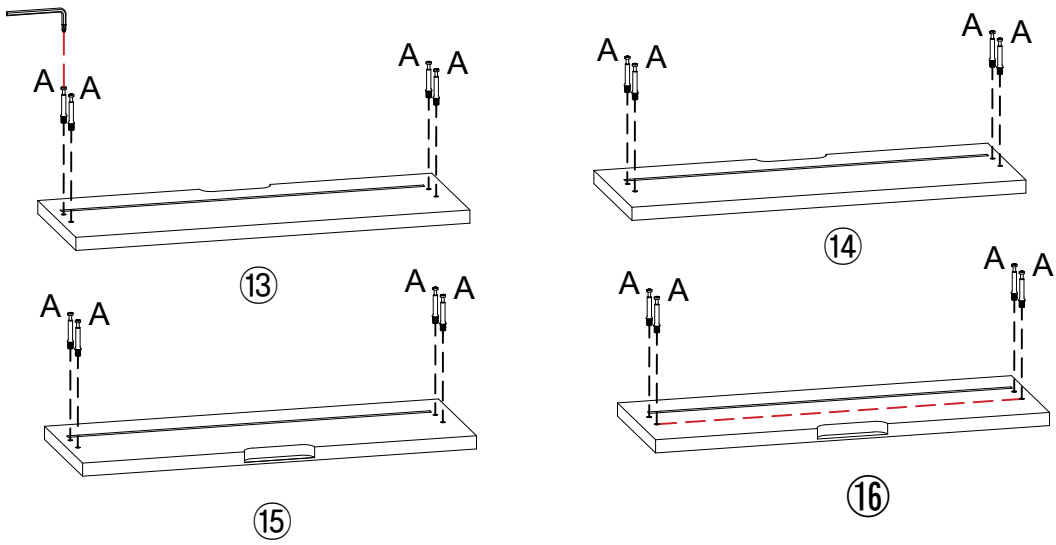

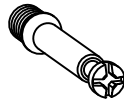
STEP 9

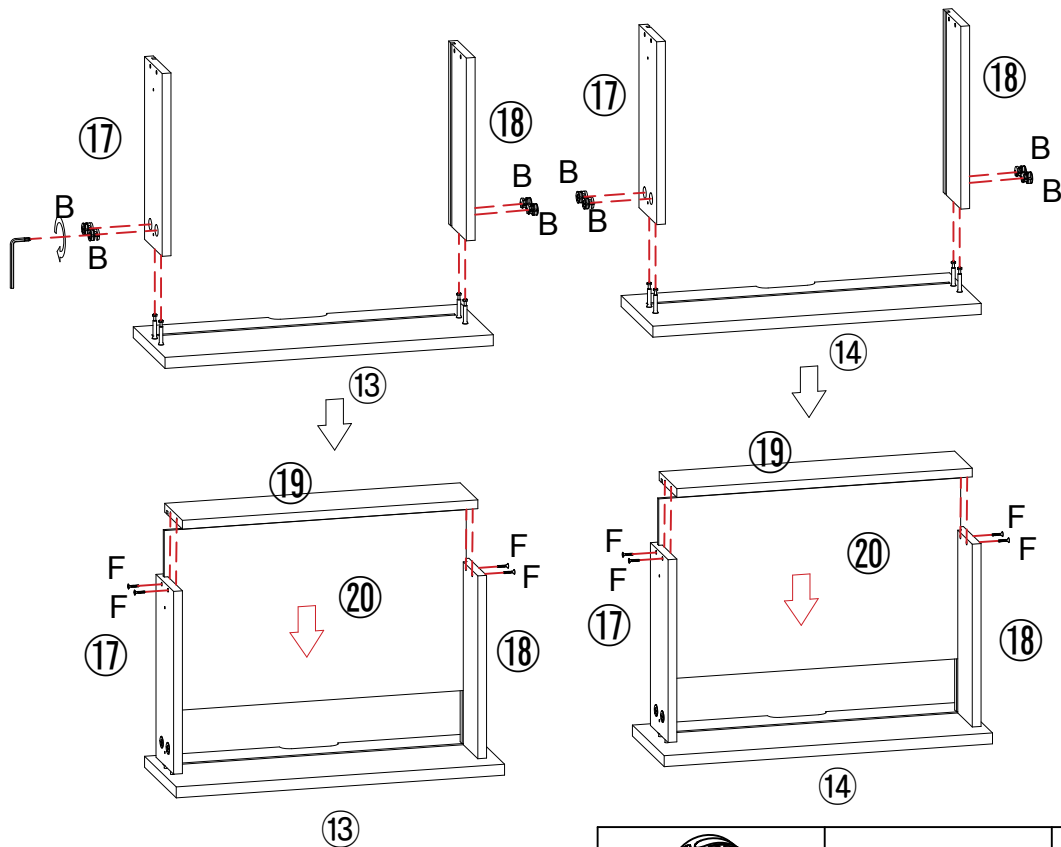

	
A x16pcs	L x1pc

STEP 10





		
B x8pcs	F x 8pcs	l x1pc

Assembly Instructions

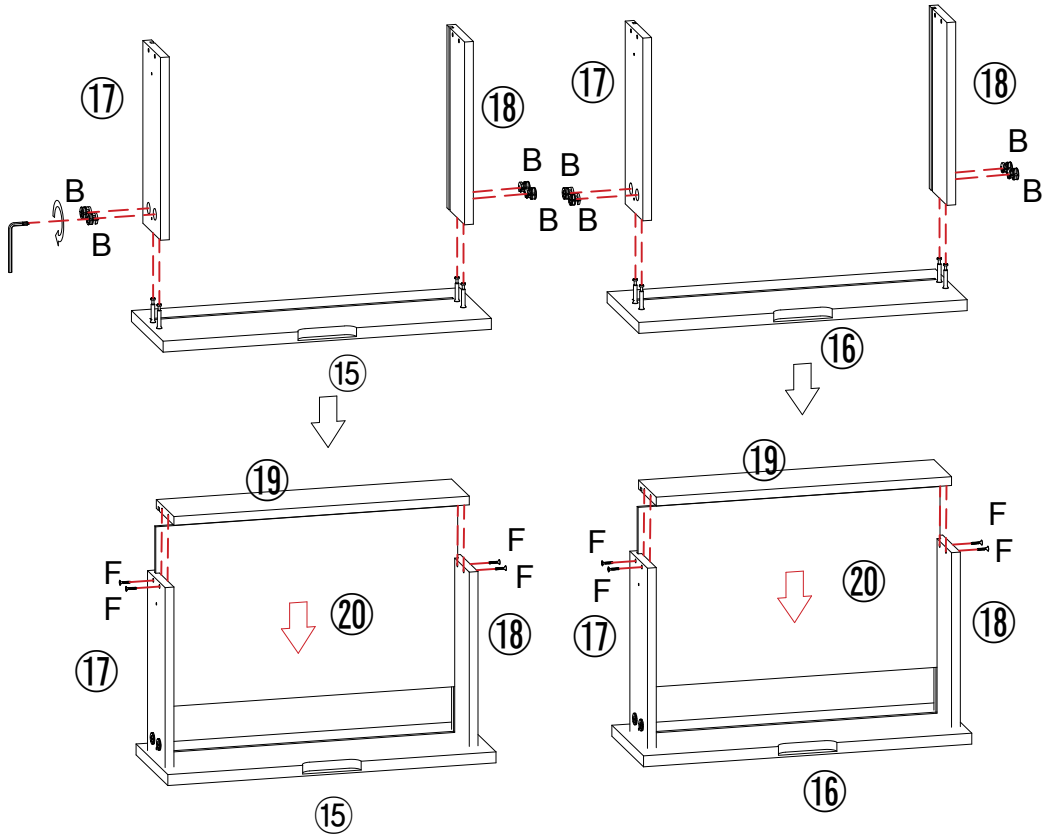

STEP 11

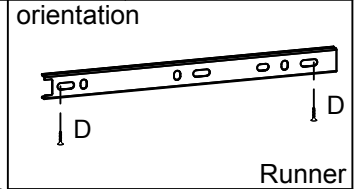
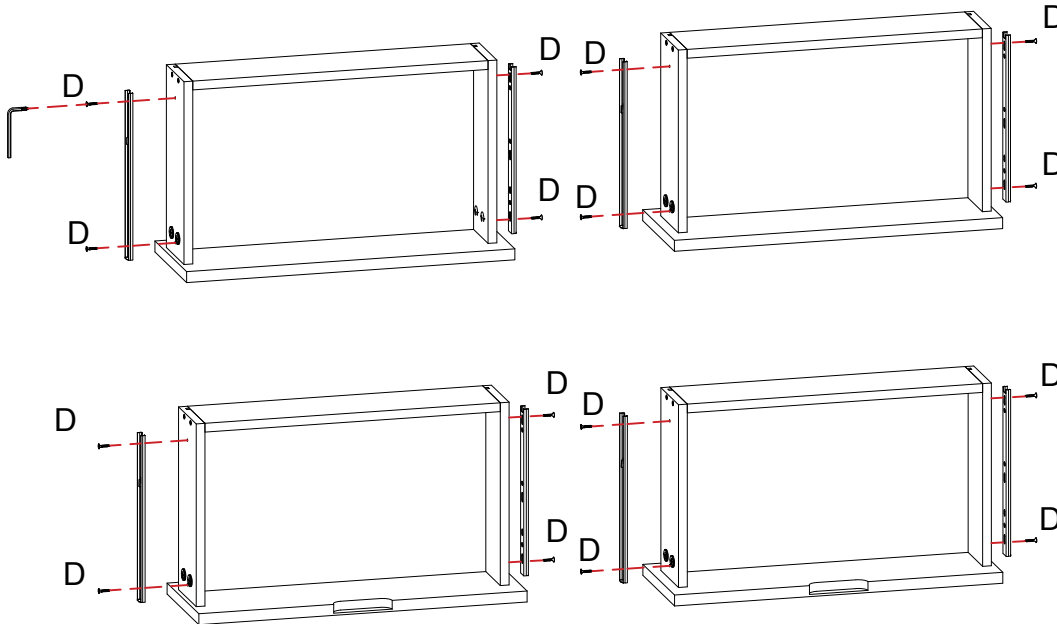

		
B x8pcs	F x 8pcs	I x1pc

STEP 12



		
D x 16pcs	Runner E x8pcs	I x1pc

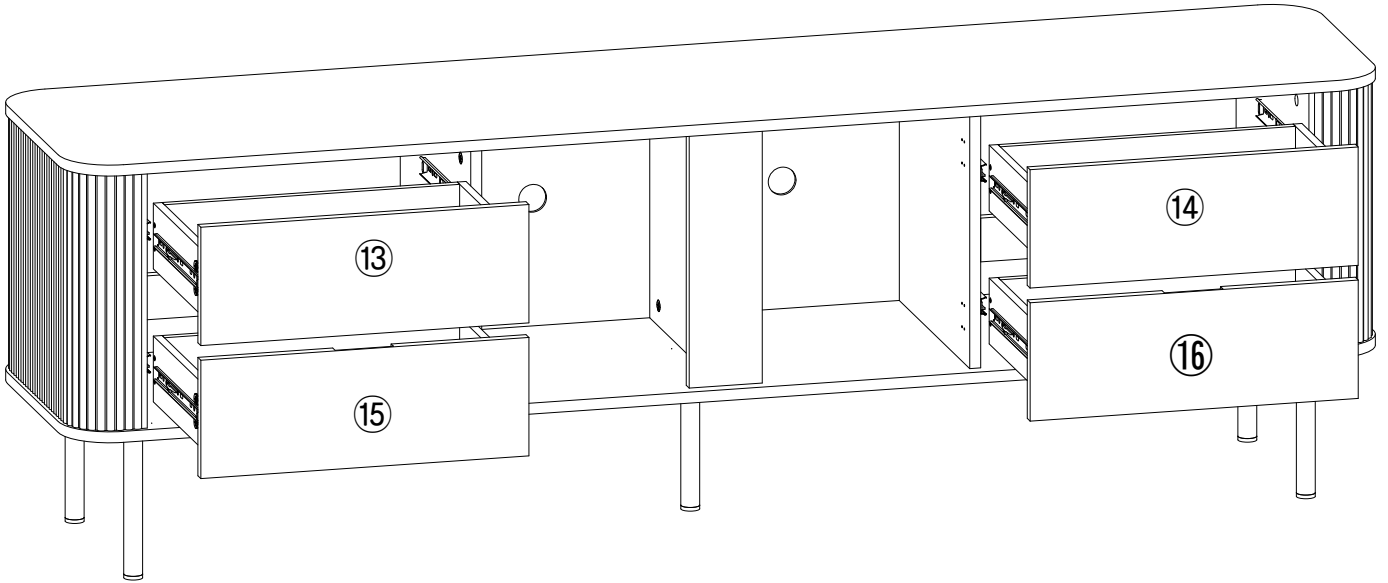

Assembly Instructions

STEP 13

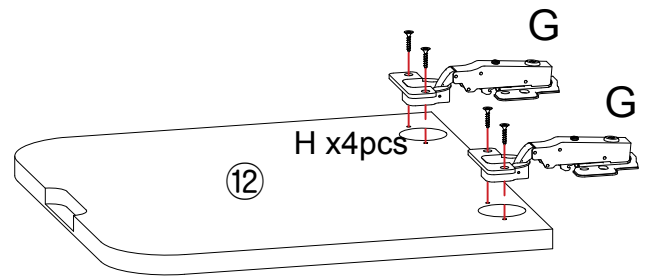
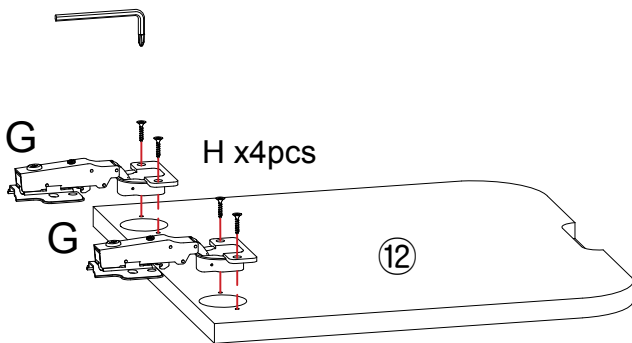

STEP 14



		
G x4pcs	H x 8pcs	I x1pc

Assembly Instructions

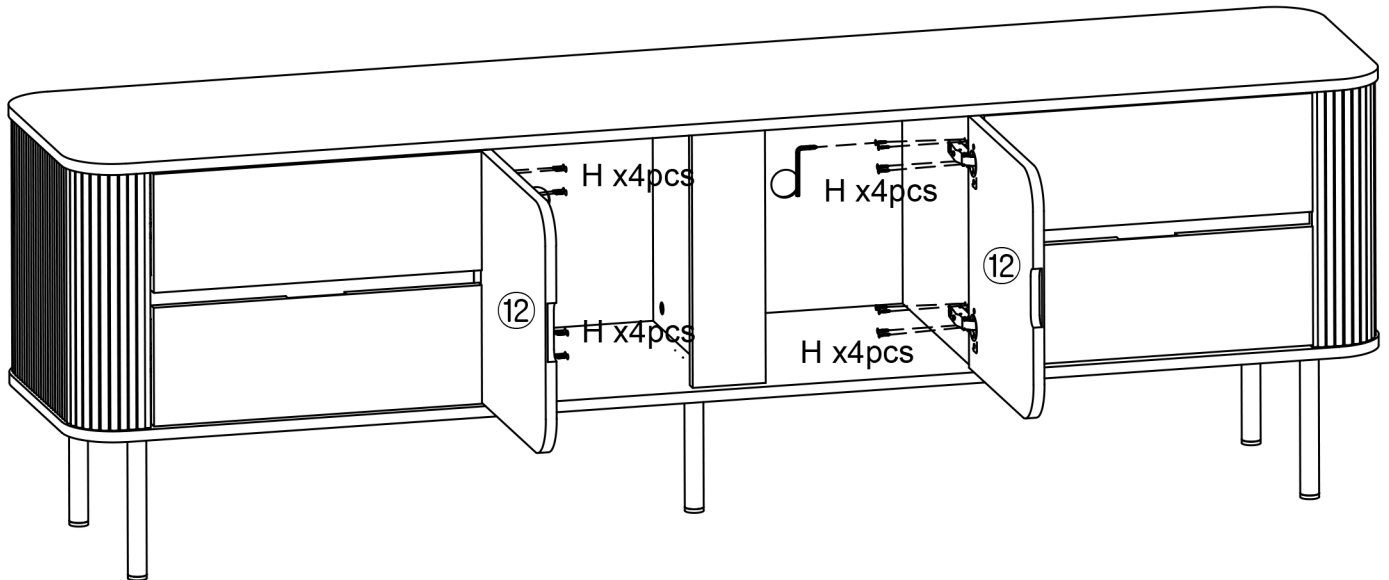

STEP 15

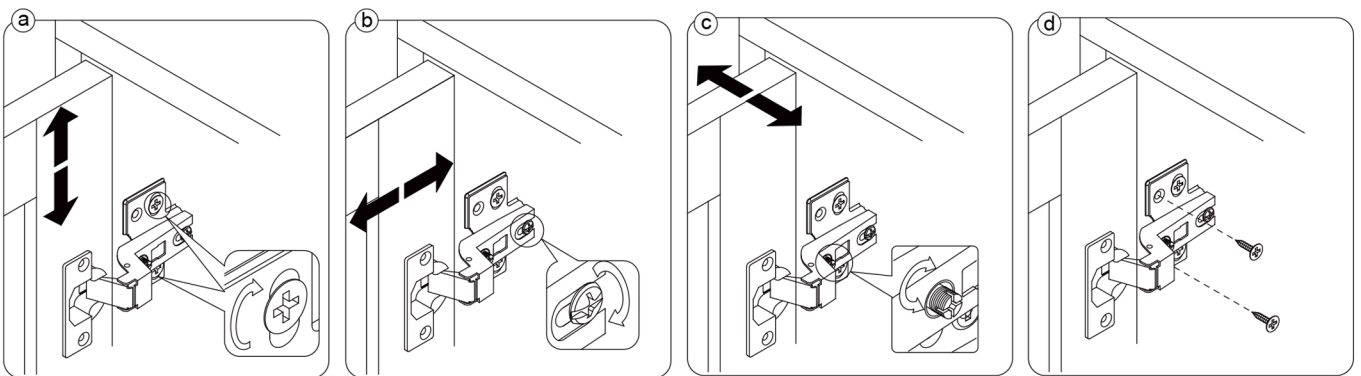

When the hinges are installed, you can refer to the pictures to adjust crevice of the doors till it's perfect:



1. To adjust the doors up and down, please refer to step (a)
2. To adjust the distance between the doors and side panels, please refer to step(b)
3. To adjust the gap between two doors, please refer to step (c)
4. After the adjustment finished, please tight the screws, refer to step (d)

	
H x 16pcs	l x1pc