

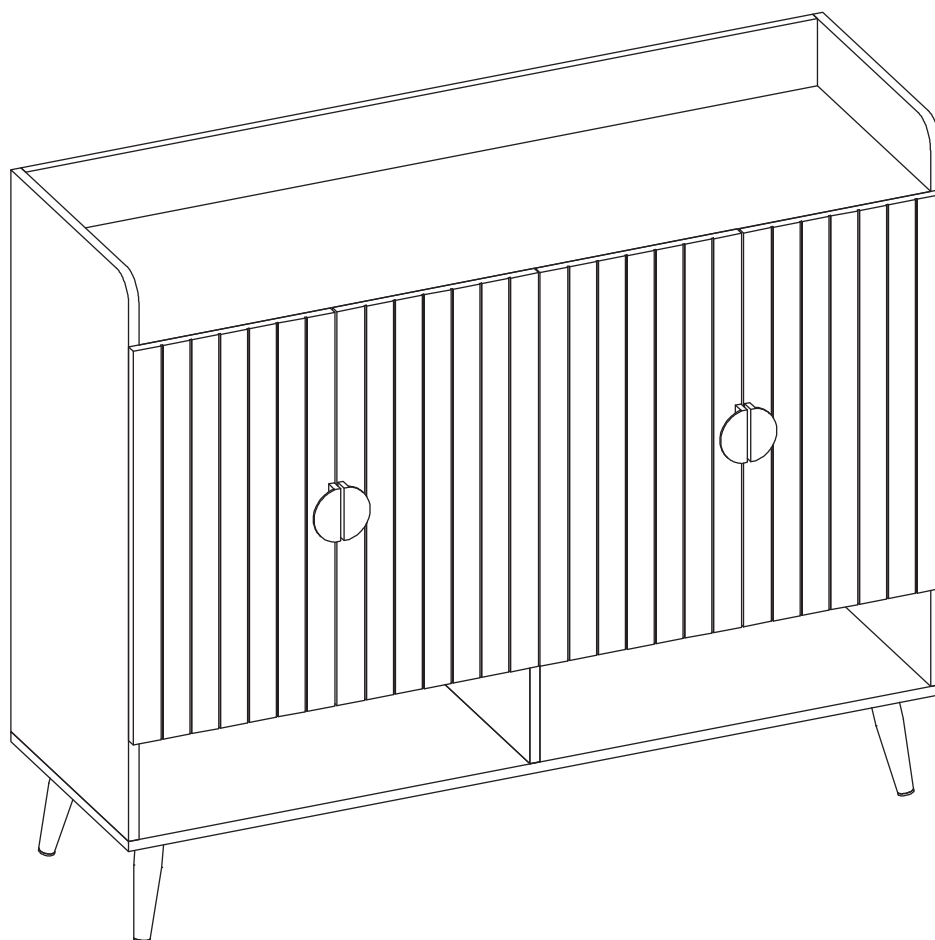

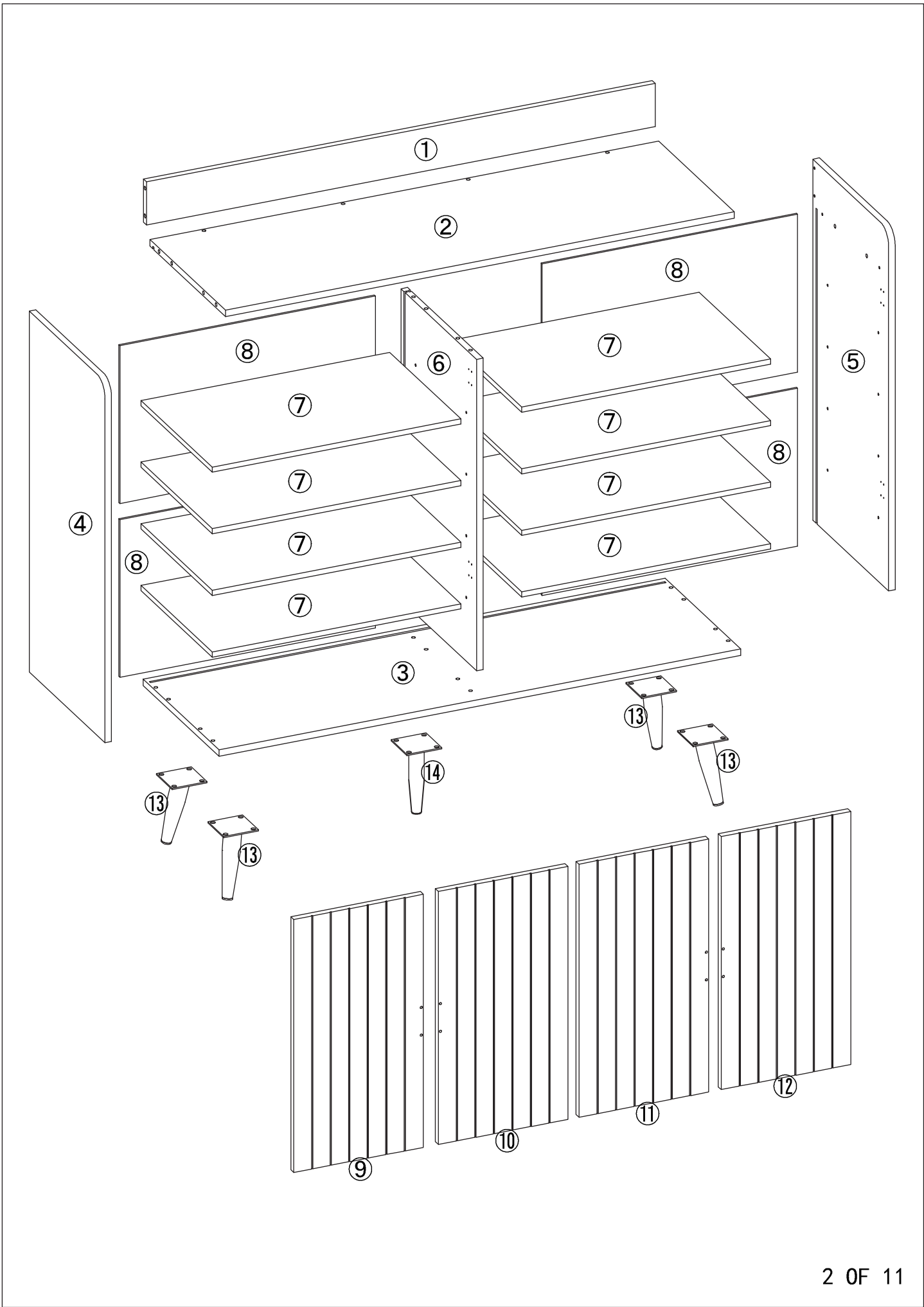







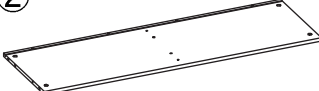
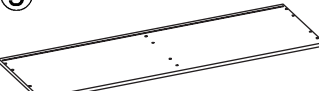
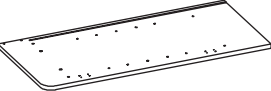
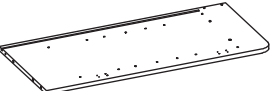
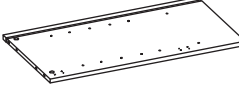



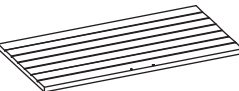



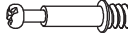

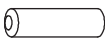

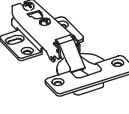
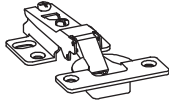

WF309200



PLEASE NOTE: The table top is covered with a tight plastic protective film. If there are scratches on the product after disassembly, please don't worry, it's not product damage. Please slowly tear off the protective plastic film on the surface along the edge. After peeling off, the product becomes smooth and clean.



①  x1	②  x1	③  x1	④  x1
⑤  x1	⑥  x1	⑦  x8	⑧  x4
⑨  x1	⑩  x1	⑪  x1	⑫  x1
⑬  x4	⑭  x1	A  6x35mm x10	B  φ15x12mm x10
C  φ8x30mm x12	D  6x40mm x10	E  M6x12mm x20	F  x4
G  x4	H  M3.5x14mm x48	I  φ5x15mm x32	J  x4
K  M4x20mm x8	L  x2	M  6x30mm x2	N  M4x35mm x2
O  M4x14mm x2	P  M4 x1		

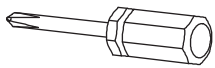

philis head screwdrier
rewuired of assembly
(not include)



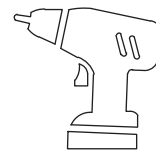

hammer
(not include)

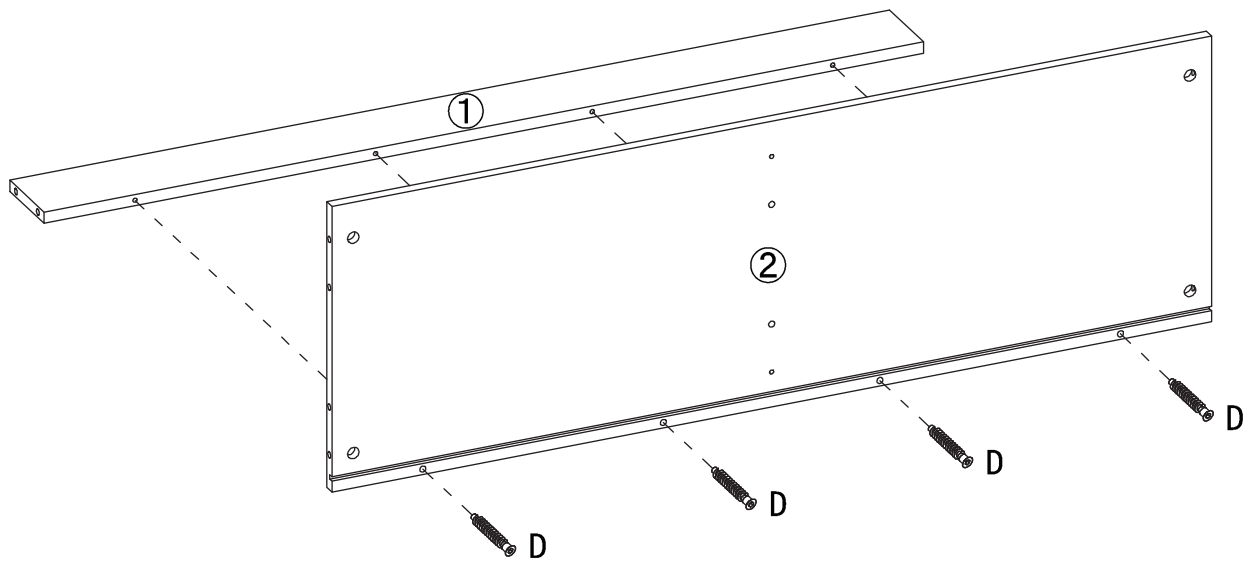

electric drill
(not include)

STEP 1



D		P	
	6x40mm x4		M4 x1

STEP 2

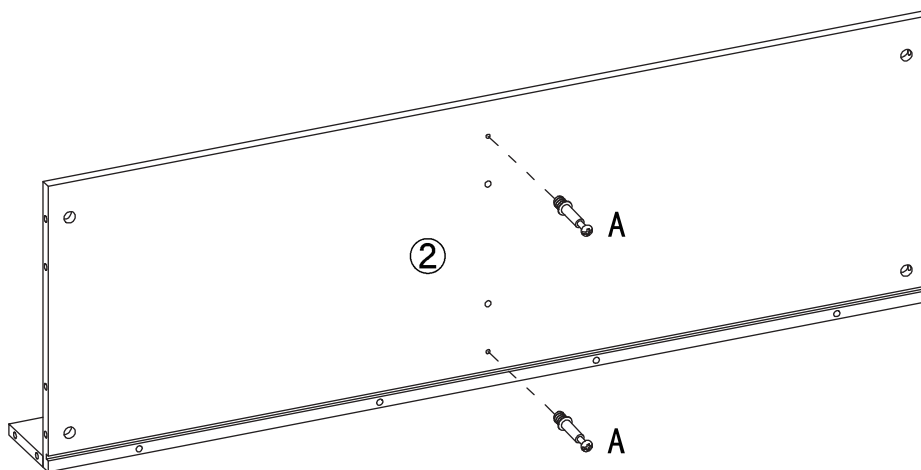

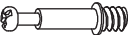
A	
	6x35mm x2

STEP3

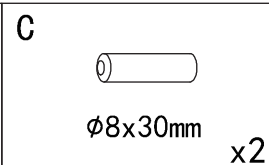
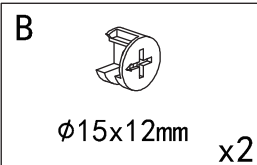
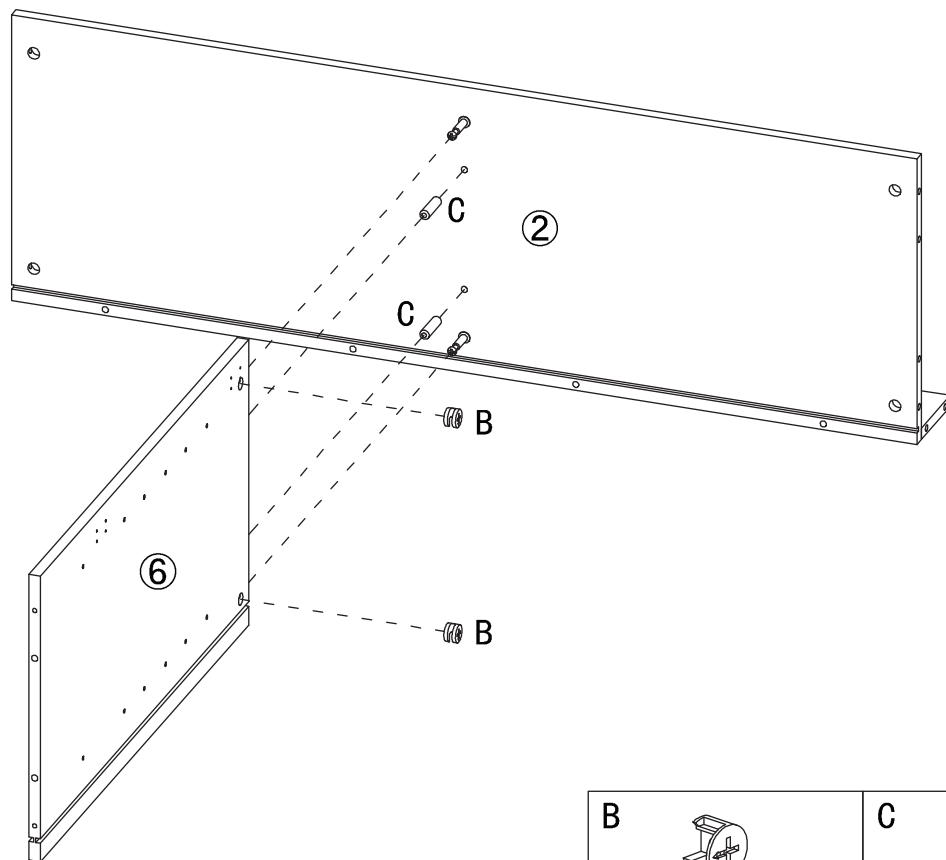

STEP4

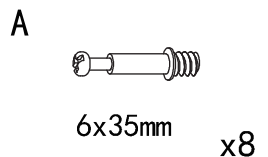
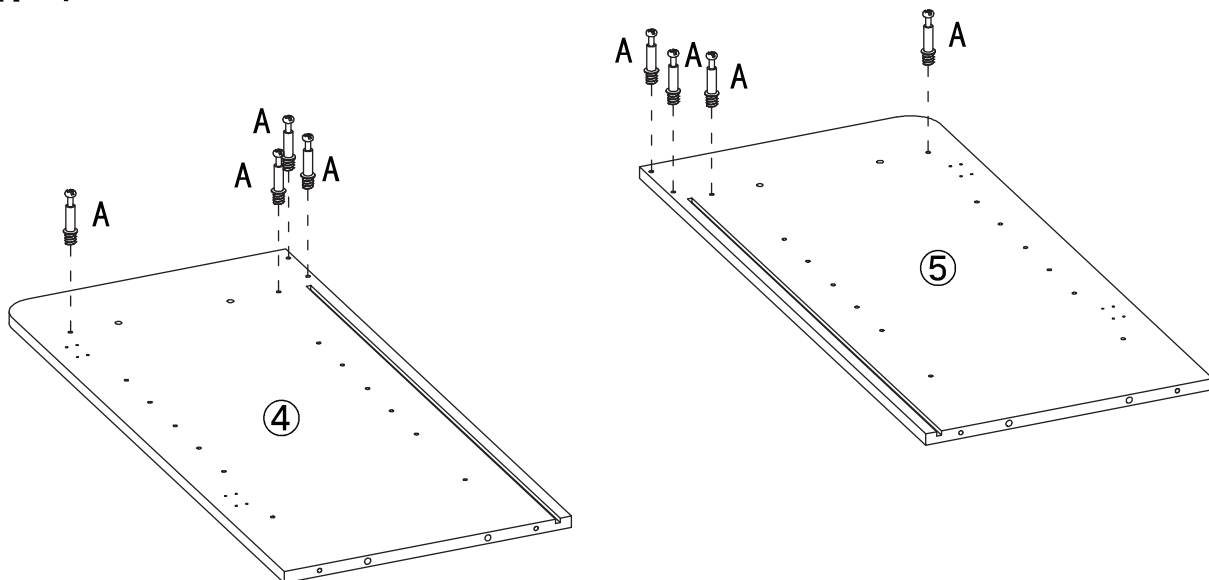

STEP5

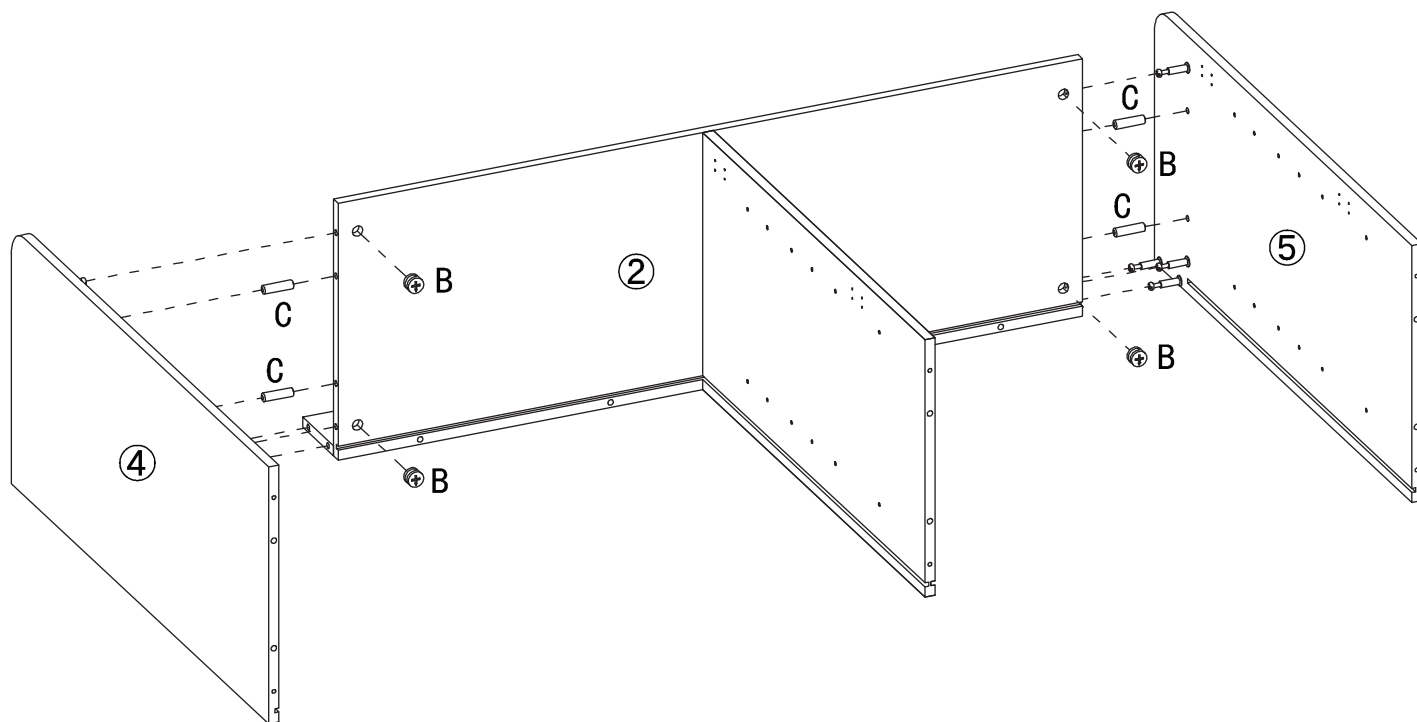

B 
Ø15x12mm x4

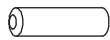

C 
Ø8x30mm x4

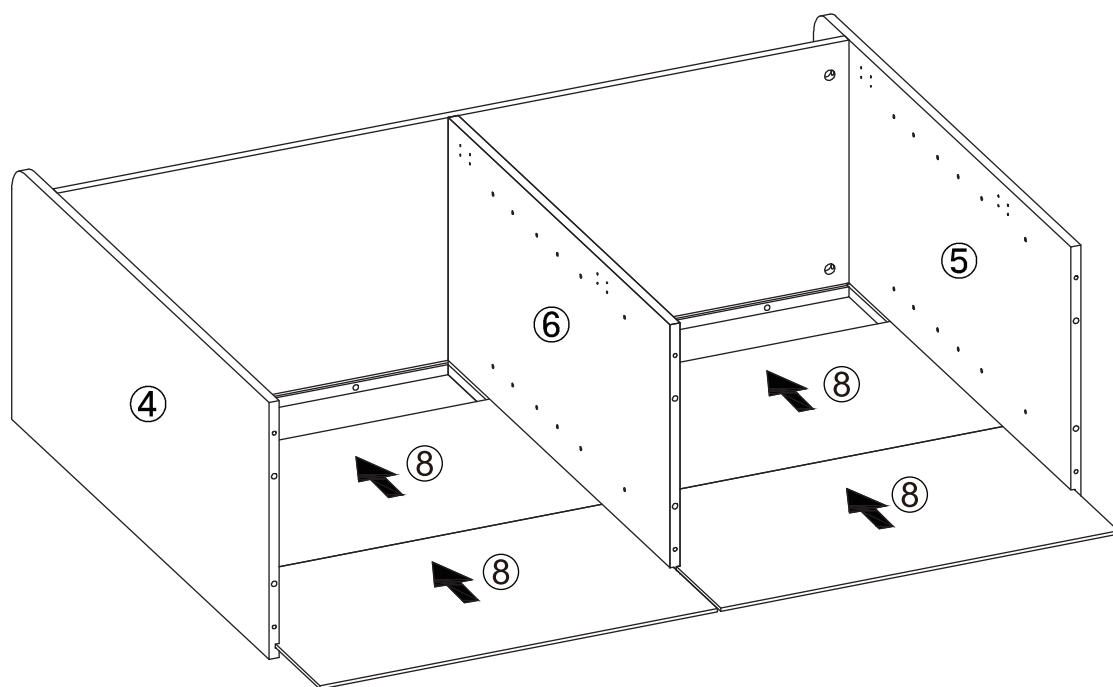
STEP6



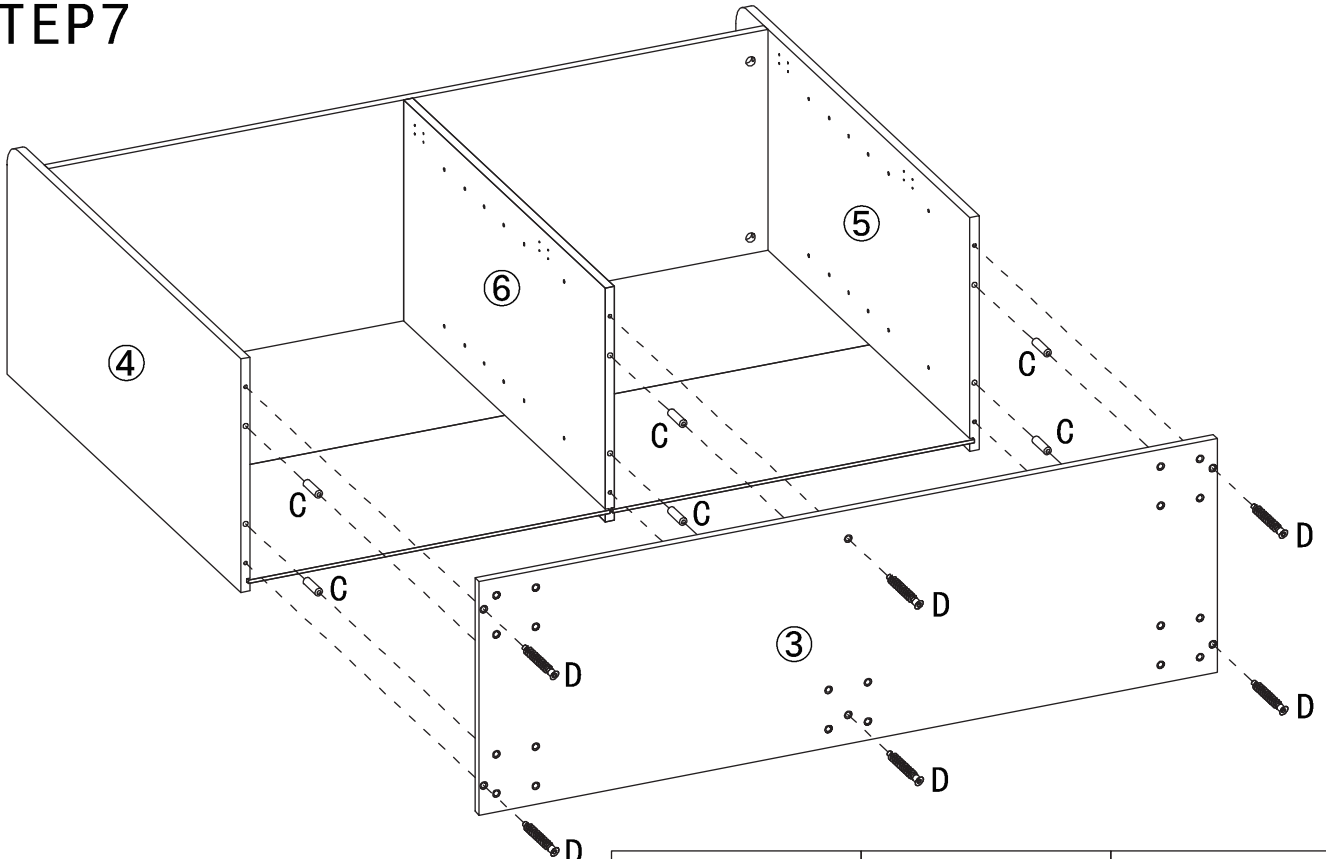

STEP 7

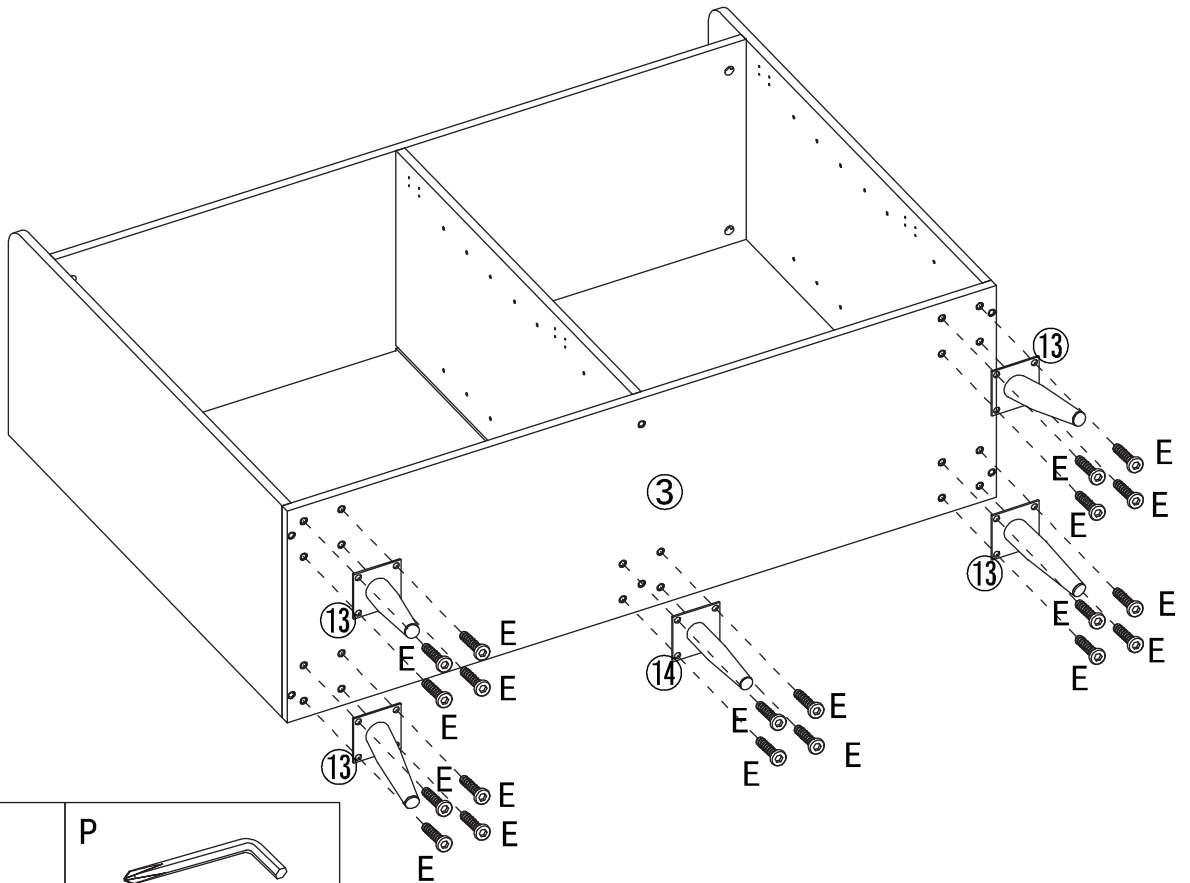

<p>C</p>  <p>ø8x30mm x6</p>	<p>D</p>  <p>6x40mm x6</p>	<p>P</p>  <p>M4 x1</p>
---	--	--

STEP 8



<p>E</p>  <p>M6x12mm x20</p>	<p>P</p>  <p>M4 x1</p>
--	--

STEP 9

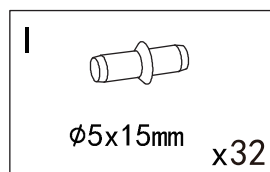
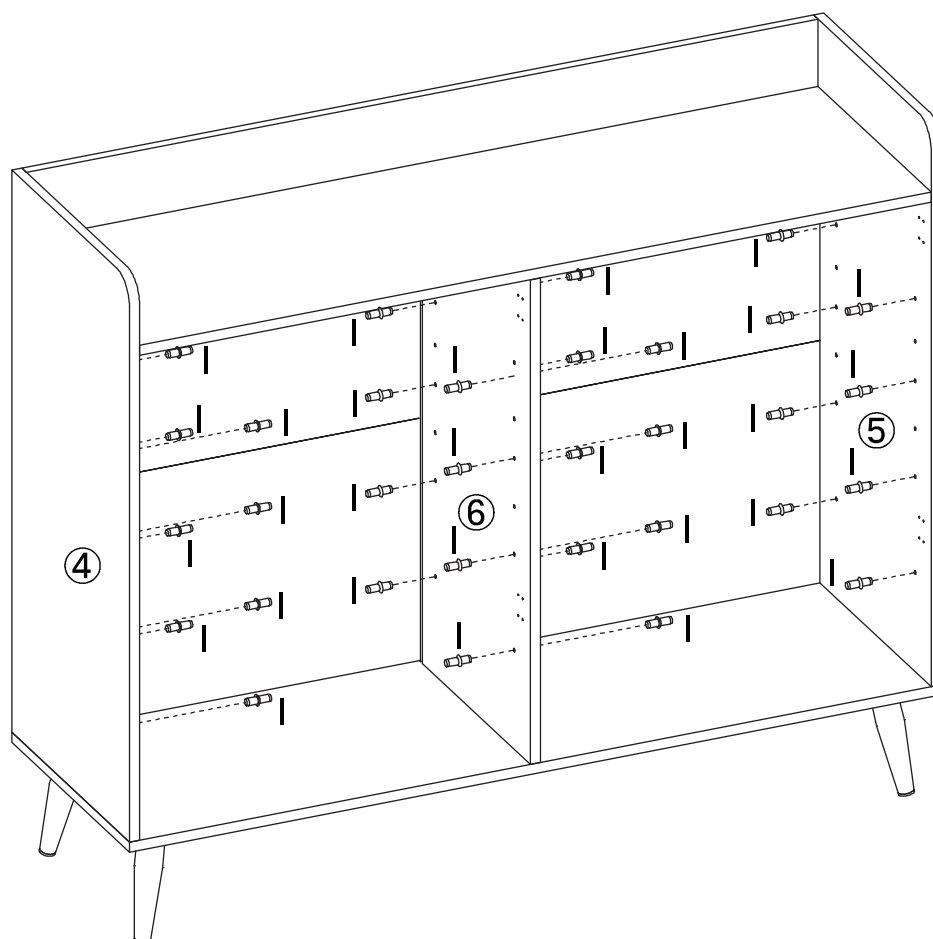

STEP 10

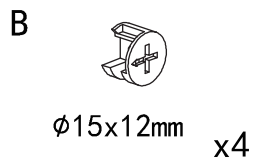
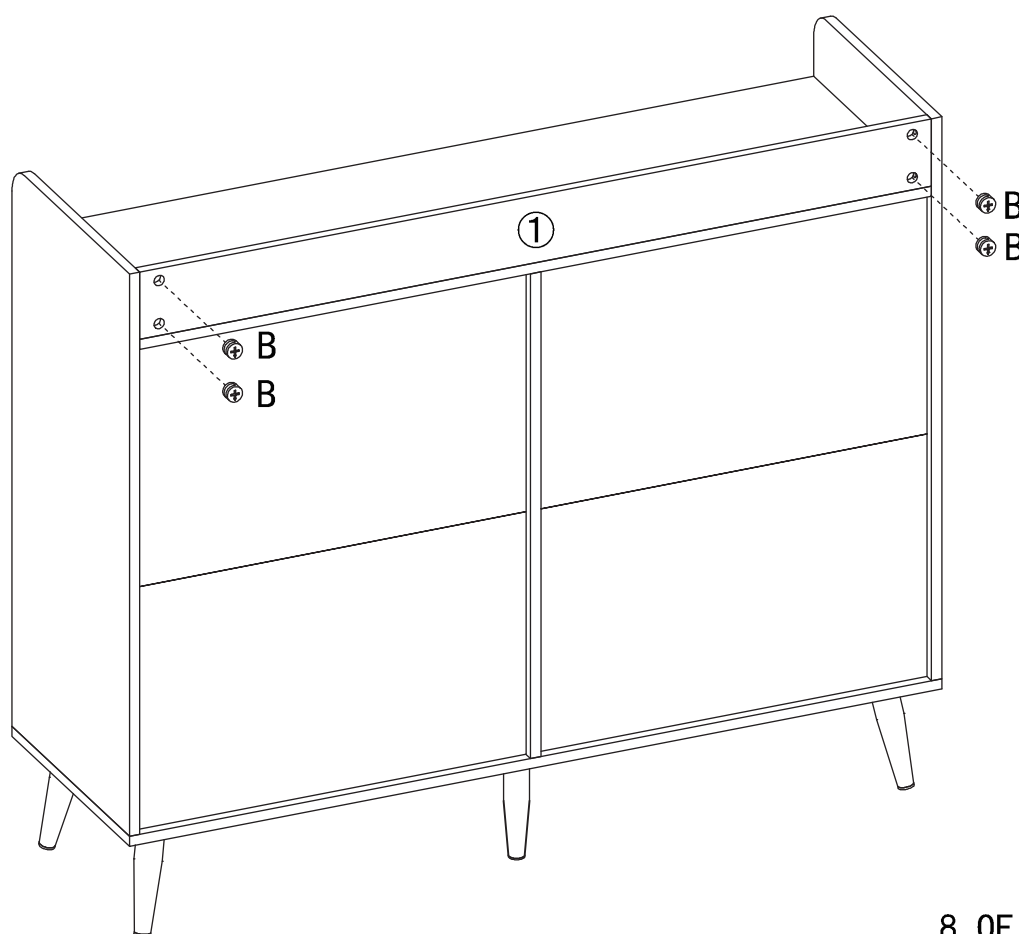

STEP 11

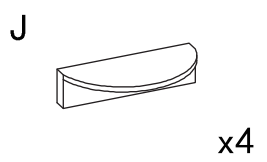
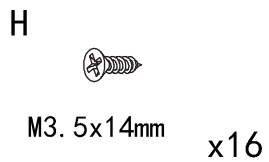
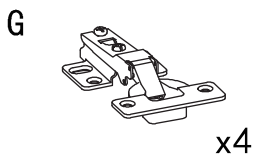
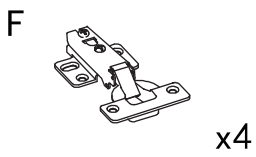
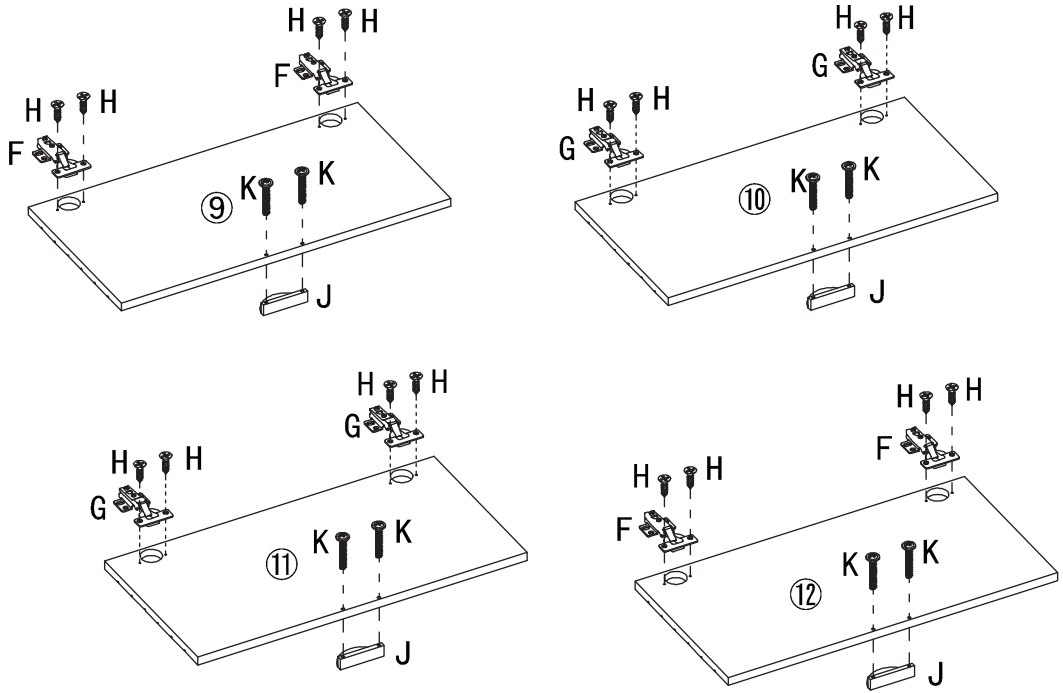

STEP 12

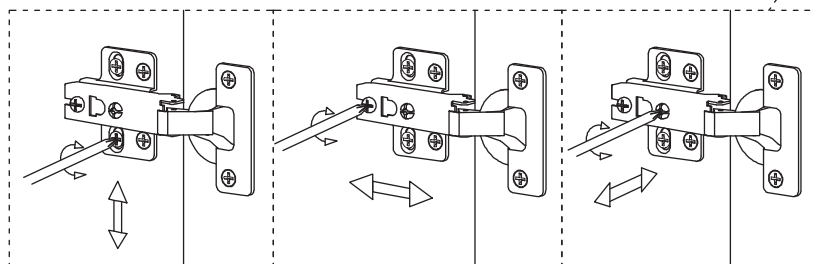
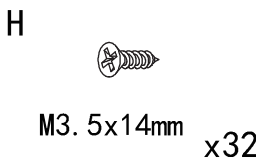
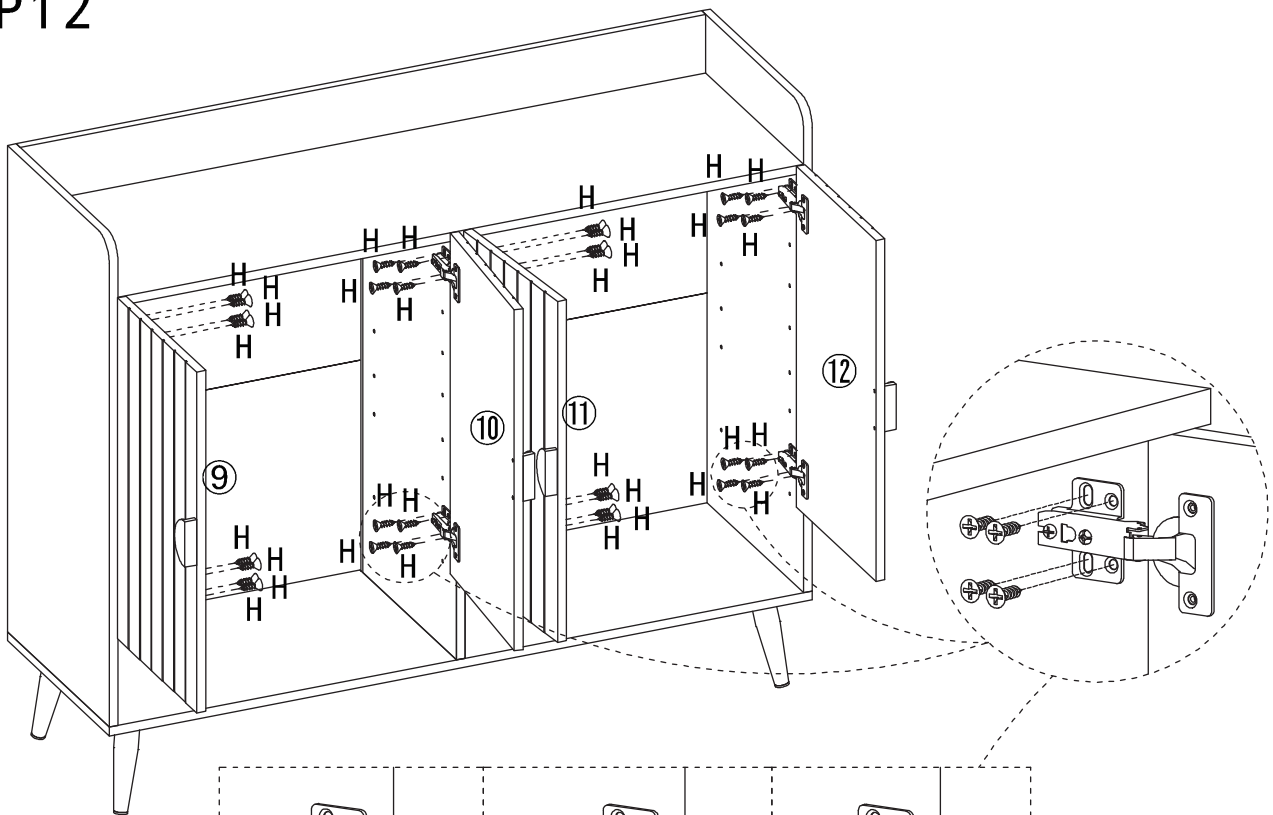

STEP 13

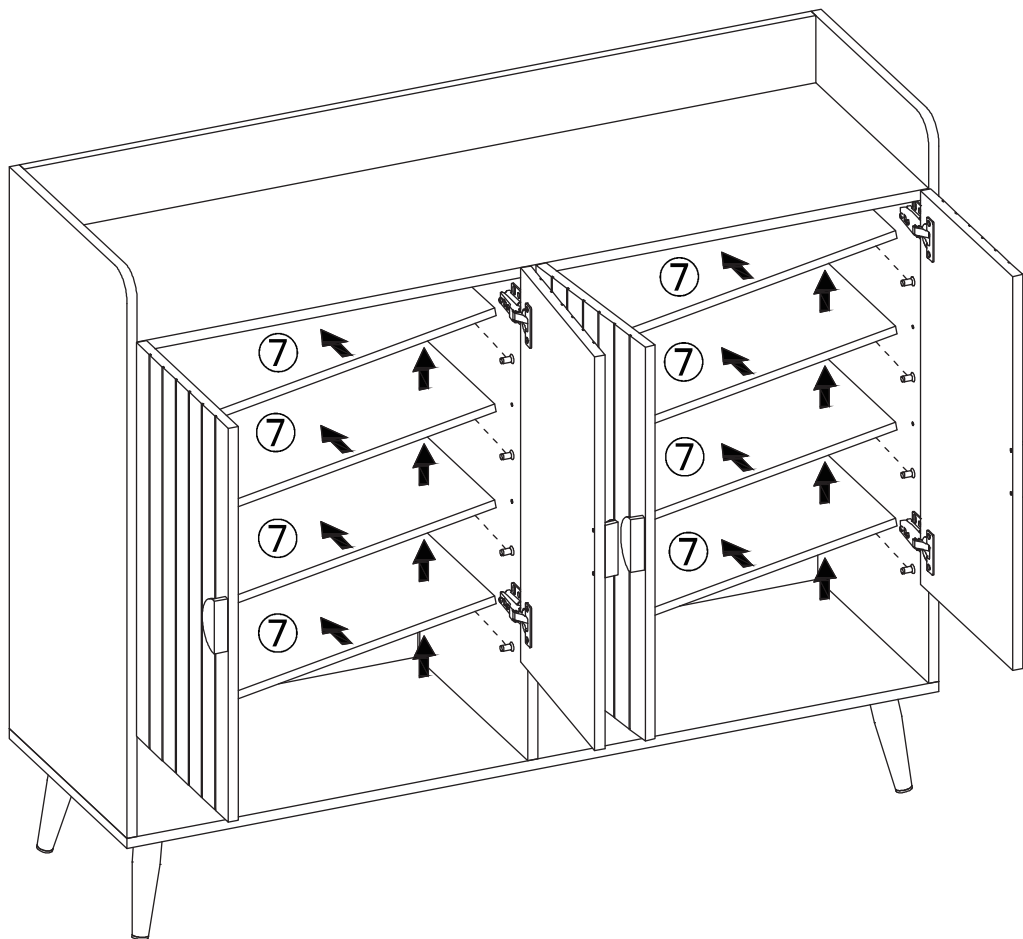

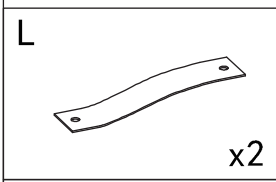
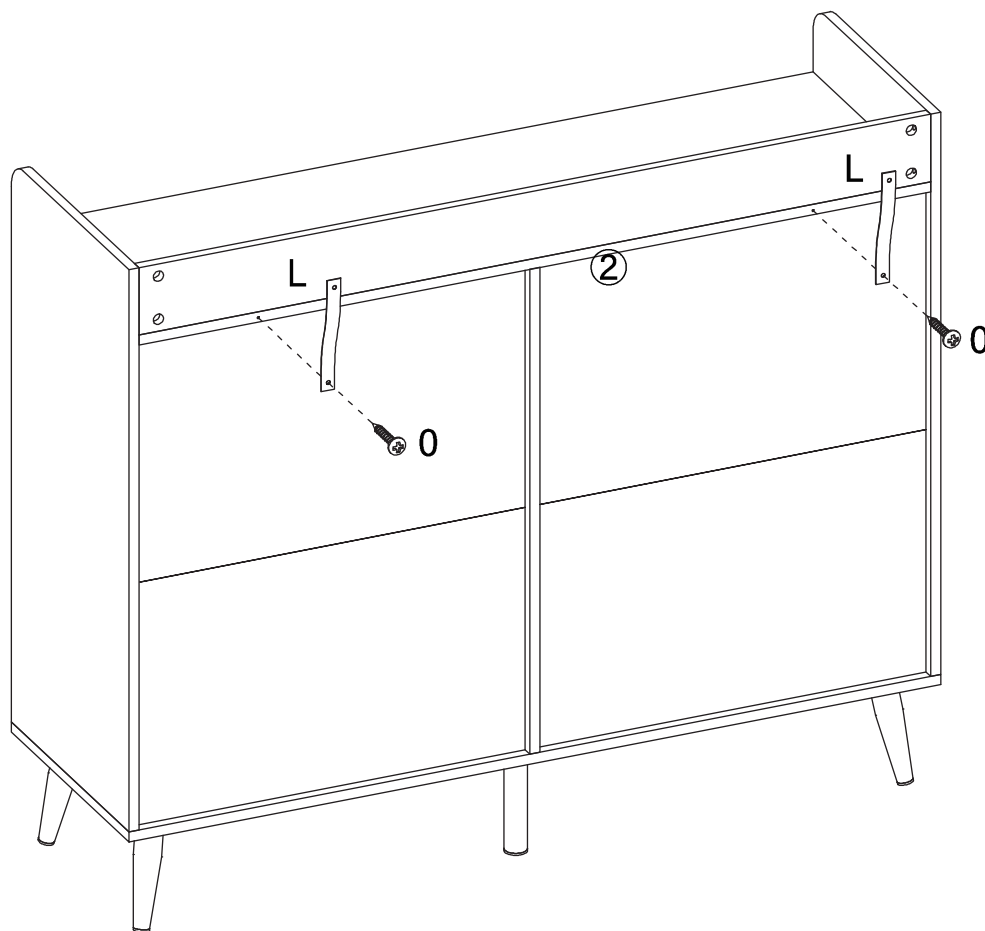

STEP 14

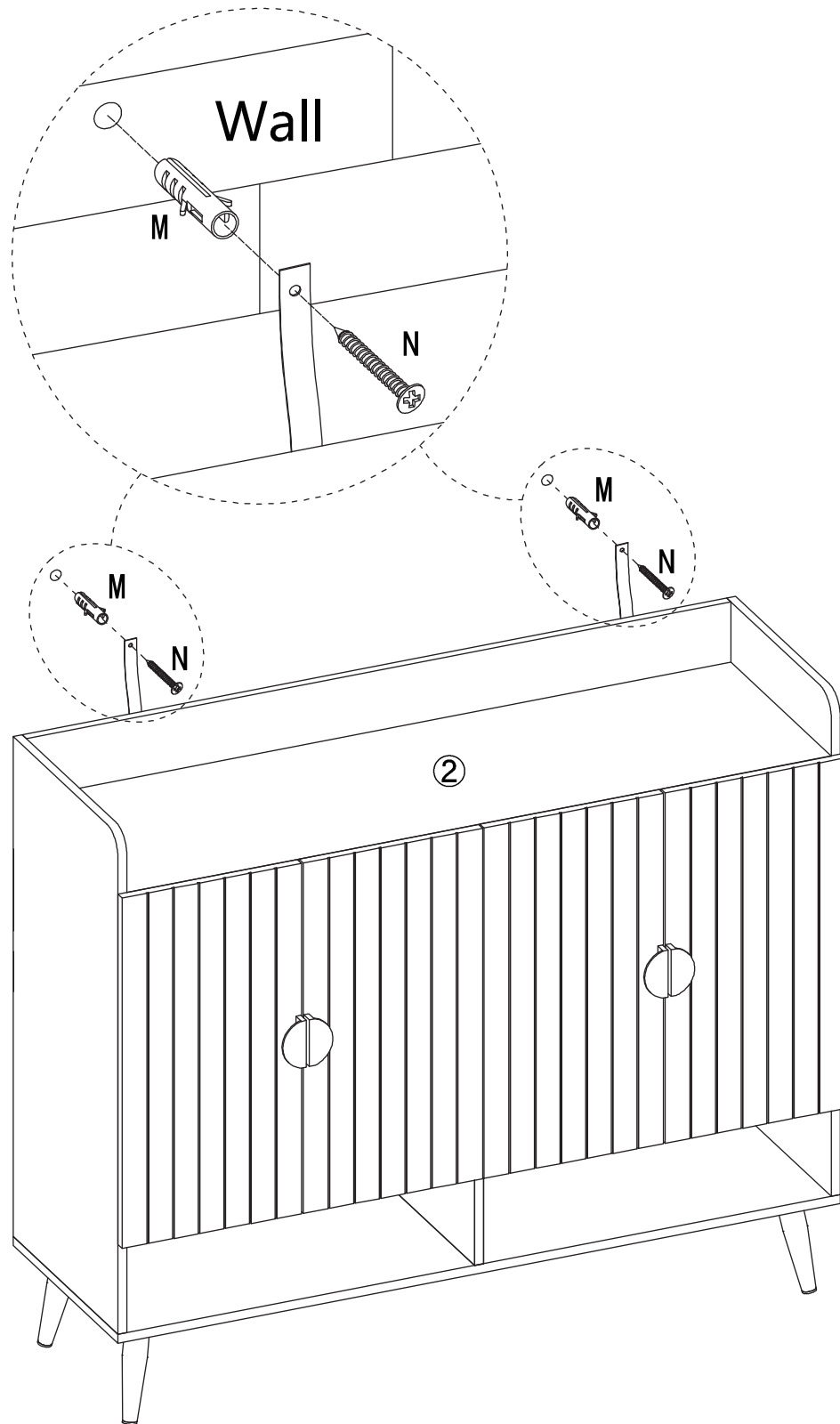

STEP 15



M  6x30mm x2	N  M4x35mm x2
---	--