

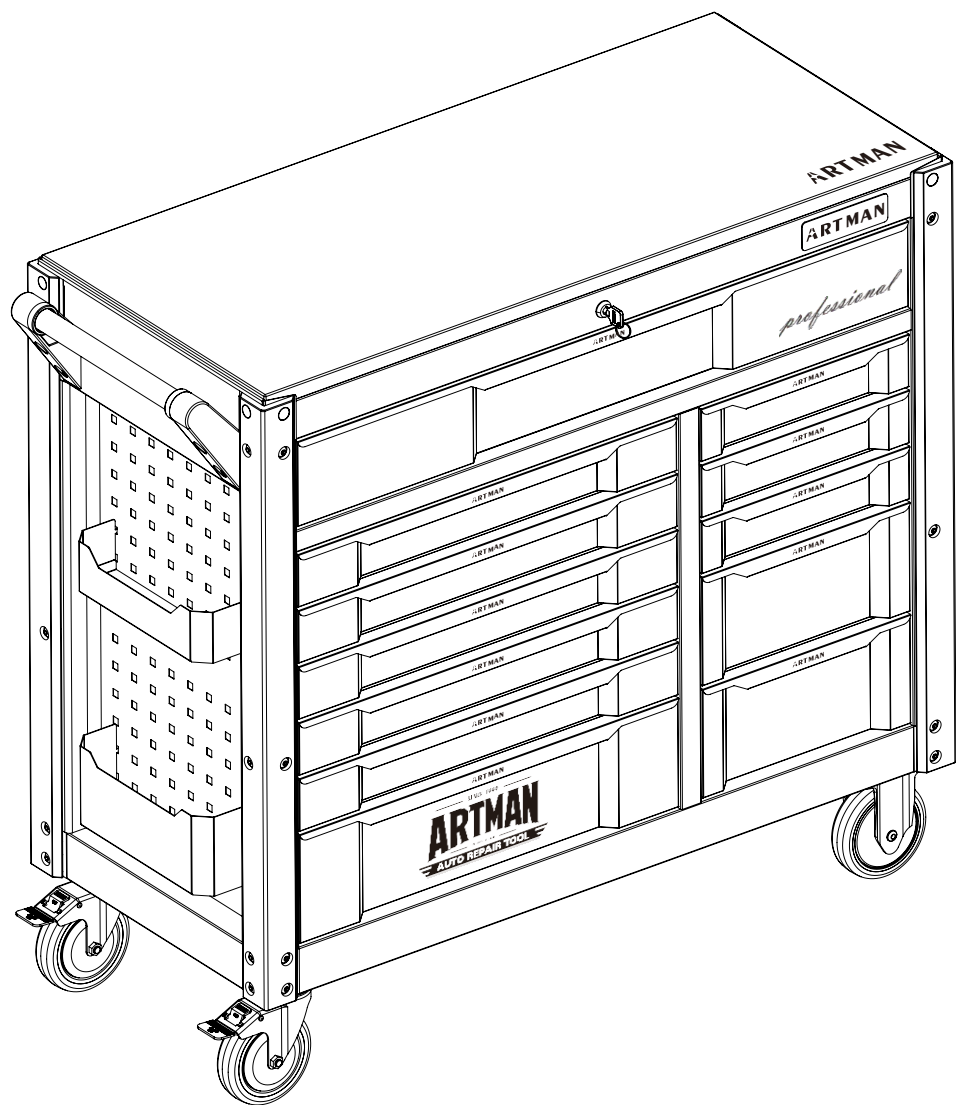









# ARTMAN



TEIL	NR.	STK.	TEIL	NR.	STK.
	1	1 PCS		6	4 PCS
	2	2 PCS		7	16 PCS
	3	2 PCS		8	16 PCS
	4	1 PCS		9	1 PCS
	5	2 PCS		10	1 PCS

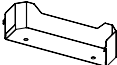
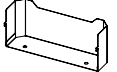