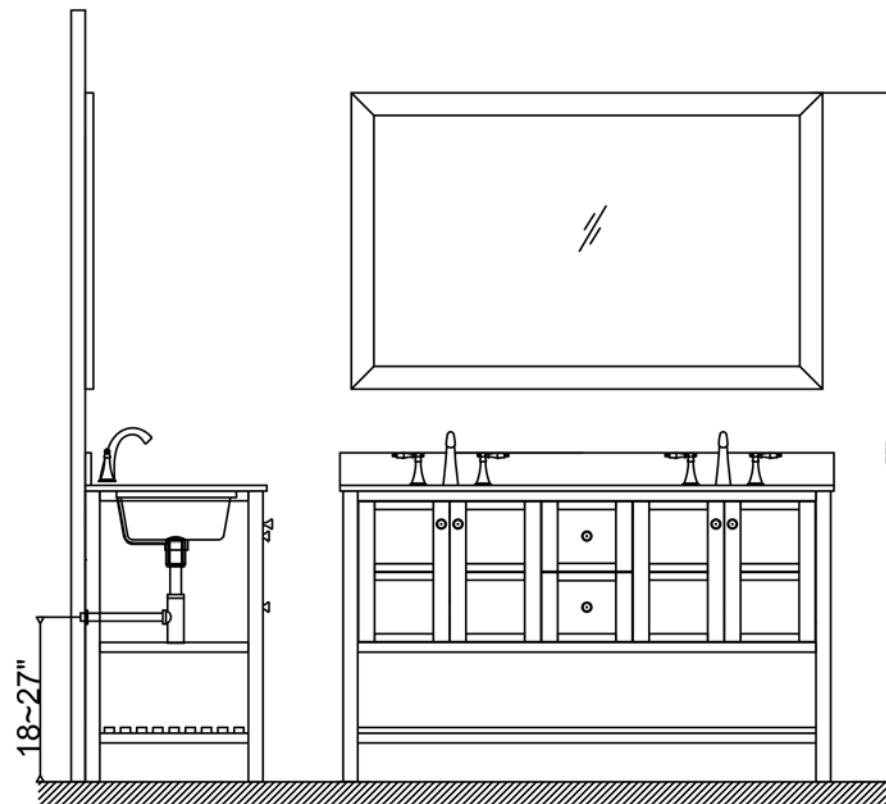

INSTALLATION INSTRUCTIONS**Confidential : A****SKU: 20060-CAB****SIZE:59.2"x21.7"x35"****PROHIBIT COPY**

Prior to installation please check received items against the Packing List Please report any missing items to your local dealer immediately.

Protect all surfaces from sharp objects, high heat sources, direct prolonged sunlight and chemical hazards .

Professional installation recommended !

**PACKING LIST**

1. Main cabinet

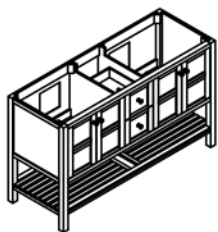

2. Mirror

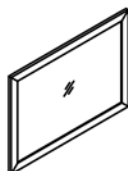

3. Basin



4. Top

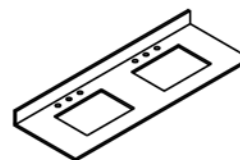

INSTALLATION INSTRUCTIONS

Confidential : A

SKU: 20060-CAB

SIZE:59.2"x21.7"x35"

PROHIBIT COPY

REQUIRED TOOLS

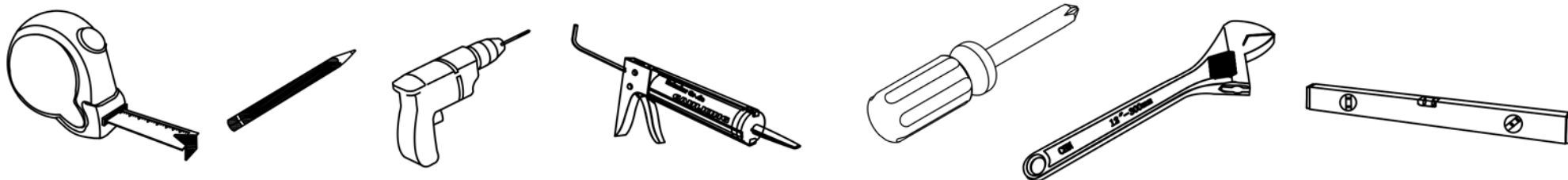

DRAWER SLIDER ATTACHMENT AND DETACHMENT

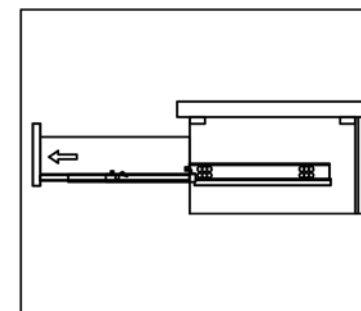
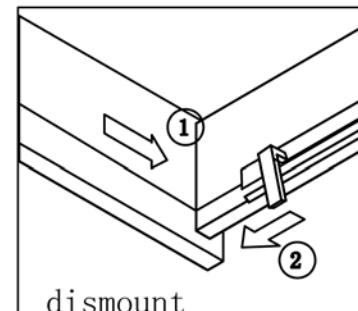
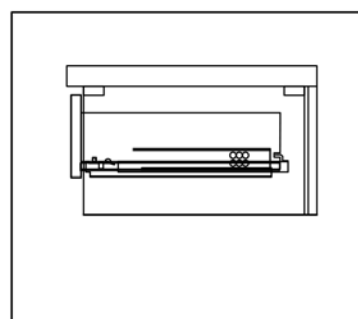
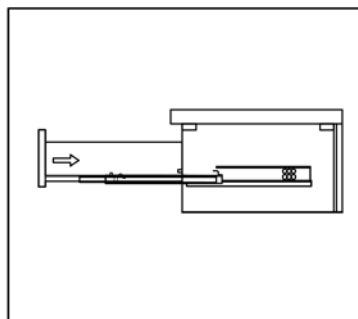
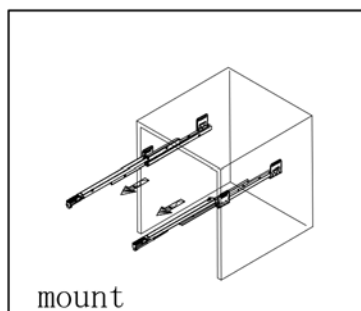

INSTALLATION AND ADJUSTION OF HINGE

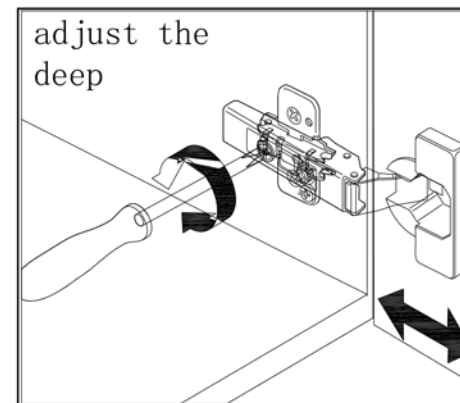
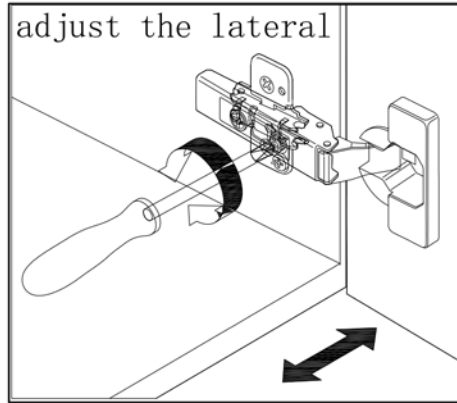
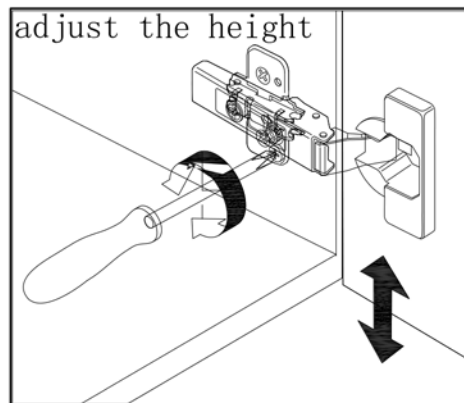

INSTALLATION INSTRUCTIONS

Confidential : A

SKU: 20060-CAB

SIZE:59.2"x21.7"x35"

PROHIBIT COPY

