

INSTALLATION INSTRUCTIONS

BEFORE INSTALLATION

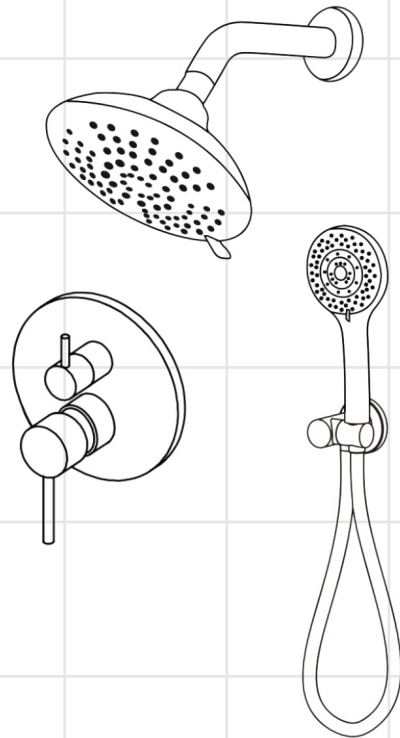

Specifications

DESCRIPTION

- Solid brass construction
- Premium finish resist corrosion and tarnishing
- Feature a waterfall spout
- Hand shower with back flow protection
- 60"(1500mm) rubber hose included
- Feature a pressure balance valve
- Suitable for wall mounted rough-in installation

FLOW

- Faucet maximum 4 gpm @ 60 psi
- Hand shower maximum 2 gpm (7.6L/min)

WARRANTY

- Lifetime limited warranty against leaks, drips and finish defects from the original date of purchase. (Improper care and cleaning will void the warranty)
- 3months warranty if used in commercial installations

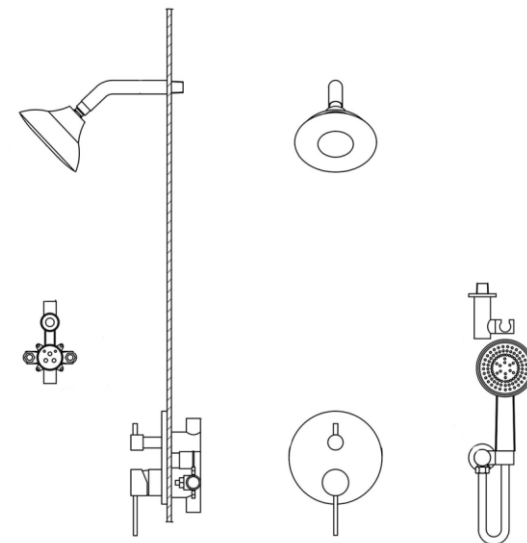
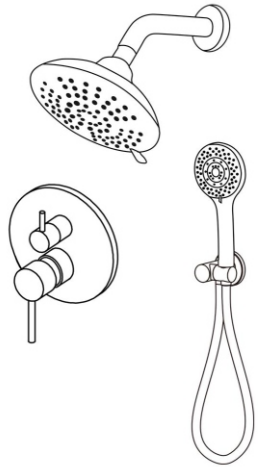

BEFORE INSTALLATION

1. Check the package and confirm all parts are included. If any part is missing or damaged, please contact us.
2. Do not disassemble the main body, as it has been installed & commissioned correctly & precisely before leaving the factory.
3. Shut off the main water supply prior to beginning installation.
4. Do flush the water supply lines to remove any dirt and debris before installation (**IMPORTANT**).
5. Make sure to connect the hot / cold inlet pipe correctly. If standing in front, connect hot water pipe to the left and cold water pipe to the right.
6. After the installation, check for leaks and make sure every joint is safely sealed.

INSTALLATION STEPS

This product has been inspected and debugged by the factory to the best condition. Please do not disassemble and assemble it yourself.

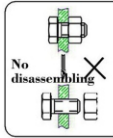

Before installing the faucet, please be sure to remove sundries and sludge from the water pipe to prevent sundries from blocking the faucet.

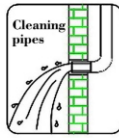

Wall Mounted Bathtub Faucet Installation

INSTALLATION MANUAL Tools You will need

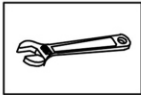

Adjustable Wrench



Allen key

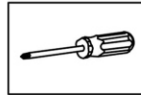

Philips Screwdriver



Teflon Tape

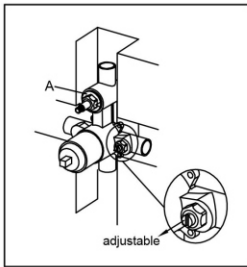

1. Fix the shower valve (A) into the wall. Use a level to ensure that the valve is straight and level.

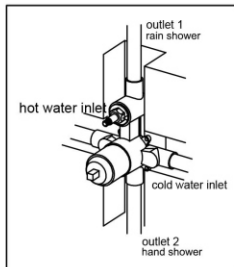

2. Wrap Teflon tape around the pipe threads and connect hot and cold water supply lines and in-wall pipes (not included) as desired to the valve. Turn on water supply and open the cartridge to check for leakage. Then, put on the protective cover.

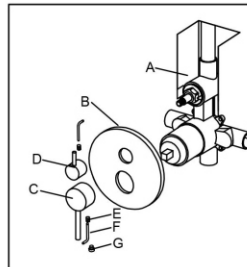

3. Remove the protective cover when the finished wall is completed and install the escutcheon (B) to the valve (A) and press it against the finished wall. Then, install the handle (C) and diverter knob (D), tighten set screws (E) with Allen key (F), and put on the indication buttons (G).

INSTALLATION STEPS

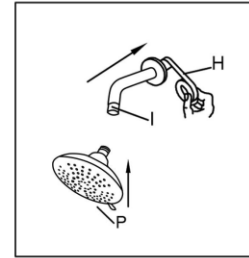

4. Turn the water on for 1 minute to flush any debris. Apply Teflon tape (H) to the threaded tail pipe and install the shower hose (I) into the outlet on the wall. Then connect the top shower (P) to the spout.

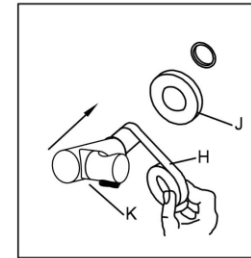

5. Apply Teflon tape (H) to the threaded end, then fix the cover plate (J) onto the wall supply holder (K) and screw the wall supply holder (K) into the wall supply holder (K) into the hand shower outlet.

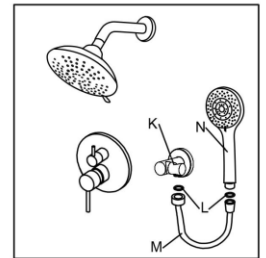

6. Add rubber washers (L) at both ends of the shower hose (M). Connect shower hose (M) to the wall supply holder (K) and hand shower (N). Then, place the hand shower (N) to the wall supply holder (K).

INSTALLATION STEPS

In order to keep the appearance of faucet clean, bright and good performance, please take care of the faucet as follows;

1. Rinse with water only and dry with soft cotton cloth;
2. Use mild liquid and colorless glass cleaner to remove surface dirt and scale film, or use polish without abrasive effect;
3. Do not use abrasive detergent, polish, emery cloth, paper towel or scraper, etc.;
4. Do not use acid cleaner, or cleaner and soap with insoluble gran etc.;
5. In the process of use, mud may accumulate in the bubbler and make the water flow show. The bubbler can be unscrewed, rinsed with water, and then installed back in place.

